

General Description

These N-Channel enhancement mode power field effect transistors are using trench DMOS technology. This advanced technology has been especially tailored to minimize on-state resistance, provide superior switching performance, and withstand high energy pulse in the avalanche and commutation mode. These devices are well suited for high efficiency fast switching applications.

	BVDSS	RDSON	ID
Q1	30V	9.5mΩ	43A
Q2	30V	4.2mΩ	85A

Features

- Improved dv/dt capability
- Fast switching
- 100% EAS Guaranteed
- Green Device Available

PPAK5x6 Asymmetric Dual Pin Configuration

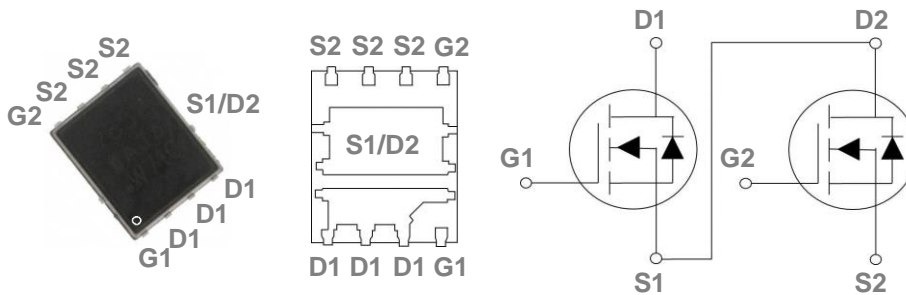

Applications

- MB / VGA / Vcore
- POL Buck Applications
- SMPS 2nd SR

Absolute Maximum Ratings $T_c=25^\circ\text{C}$ unless otherwise noted

Symbol	Parameter	Q1	Q2	Units
V_{DS}	Drain-Source Voltage	30	30	V
V_{GS}	Gate-Source Voltage	± 20	± 20	V
I_D	Drain Current – Continuous ($T_c=25^\circ\text{C}$)	43	85	A
	Drain Current – Continuous ($T_c=100^\circ\text{C}$)	27.2	54	A
I_{DM}	Drain Current – Pulsed ¹ , Chip/Package Limit	172	340	A
EAS	Single Pulse Avalanche Energy ²	45	88	mJ
IAS	Single Pulse Avalanche Current ²	30	42	A
P_D	Power Dissipation ($T_c=25^\circ\text{C}$)	27.2	48	W
	Power Dissipation – Derate above 25°C	0.22	0.38	W/ $^\circ\text{C}$
T_{STG}	Storage Temperature Range	-55 to 150		$^\circ\text{C}$
T_J	Operating Junction Temperature Range	-55 to 150		$^\circ\text{C}$

Thermal Characteristics

Symbol	Parameter	Typ.	Max.	Unit
$R_{\theta JA}$ Q1	Thermal Resistance Junction to ambient	---	62	$^\circ\text{C}/\text{W}$
$R_{\theta JA}$ Q2		---	62	$^\circ\text{C}/\text{W}$
$R_{\theta JC}$ Q1	Thermal Resistance Junction to Case	---	4.6	$^\circ\text{C}/\text{W}$
$R_{\theta JC}$ Q2		---	2.6	$^\circ\text{C}/\text{W}$

Electrical Characteristics (T_J=25 °C, unless otherwise noted)
Static State Characteristics

Symbol	Parameter	Conditions		Min.	Typ.	Max.	Unit
BV _{DSS}	Drain-Source Breakdown Voltage	V _{GS} =0V, I _D =250uA	Q1	30	---	---	V
			Q2	30	---	---	V
ΔBV _{DSS} /ΔT _J	BV _{DSS} Temperature Coefficient	Reference to 25°C, I _D =1mA	Q1	---	0.04	---	V/°C
			Q2	---	0.03	---	V/°C
I _{DSS}	Drain-Source Leakage Current	V _{DS} =30V, V _{GS} =0V, T _J =25°C	Q1	---	---	1	uA
			Q2	---	---	1	uA
		V _{DS} =24V, V _{GS} =0V, T _J =125°C	Q1	---	---	10	uA
			Q2	---	---	10	uA
I _{GSS}	Gate-Source Leakage Current	V _{GS} =±20V, V _{DS} =0V	Q1	---	---	±100	nA
			Q2	---	---	±100	nA
R _{DS(ON)}	Static Drain-Source On-Resistance ³	V _{GS} =10V, I _D =8A	Q1	---	7.5	9.5	mΩ
		V _{GS} =10V, I _D =20A	Q2	---	3.3	4.2	mΩ
		V _{GS} =4.5V, I _D =5A	Q1	---	11	14.5	mΩ
		V _{GS} =4.5V, I _D =10A	Q2	---	4.5	6	mΩ
V _{GS(th)}	Gate Threshold Voltage	V _{GS} =V _{DS} , I _D =250uA	Q1	1	1.6	2.5	V
			Q2	1	1.6	2.5	V
ΔV _{GS(th)}	V _{GS(th)} Temperature Coefficient	V _{GS} =V _{DS} , I _D =250uA	Q1	---	-4	---	mV/°C
			Q2	---	-5	---	mV/°C
g _{fs}	Forward Transconductance	V _{DS} =10V, I _D =8A	Q1	---	9.5	---	S
		V _{DS} =10V, I _D =10A	Q2	---	15.5	---	S

Dynamic Characteristics

Q _g	Total Gate Charge ^{3, 4}	V _{DS} =15V, V _{GS} =4.5V, I _D =10A	Q1	---	7.5	12	nC
			Q2	---	24	34	
Q _{gs}	Gate-Source Charge ^{3, 4}	V _{DS} =15V, V _{GS} =4.5V, I _D =10A	Q1	---	1.3	2.6	
			Q2	---	4.2	6	
Q _{gd}	Gate-Drain Charge ^{3, 4}	V _{DS} =15V, V _{GS} =4.5V, I _D =10A	Q1	---	4.5	8	
			Q2	---	13	18	
T _{d(on)}	Turn-On Delay Time ^{3, 4}	V _{DD} =15V, V _{GS} =10V, R _G =3.3Ω	Q1	---	4.8	9	ns
			Q2	---	12.6	24	
T _r	Rise Time ^{3, 4}	V _{DD} =15V, V _{GS} =10V, R _G =3.3Ω	Q1	---	12.5	24	
			Q2	---	19.5	37	
T _{d(off)}	Turn-Off Delay Time ^{3, 4}	I _D =8A	Q1	---	27.6	52	
			Q2	---	42.8	81	
T _f	Fall Time ^{3, 4}	I _D =8A	Q1	---	8.2	16	
			Q2	---	13.2	25	

C _{iss}	Input Capacitance	V _{DS} =25V , V _{GS} =0V , F=1MHz	Q1	---	680	1000	pF
			Q2	---	2200	3190	
C _{oss}	Output Capacitance		Q1	---	150	220	
			Q2	---	280	405	
C _{rss}	Reverse Transfer Capacitance		Q1	---	70	105	
			Q2	---	177	255	
R _g	Gate resistance	V _{GS} =0V, V _{DS} =0V, F=1MHz	Q1	---	2.7	5.4	Ω
			Q2	---	2	4	Ω

Guaranteed Avalanche Energy

Symbol	Parameter	Conditions	Min.	Typ.	Max.	Unit
EAS	Single Pulse Avalanche Energy	V _{DD} =25V, L=0.1mH, I _{AS} =10A	Q1	5		
		V _{DD} =25V, L=0.1mH, I _{AS} =20A	Q2	20	---	---

Drain-Source Diode Characteristics

Symbol	Parameter	Conditions	Min.	Typ.	Max.	Unit	
I _s	Continuous Source Current	V _G =V _D =0V , Force Current	Q1	---	---	43	A
			Q2	---	---	85	A
I _{SM}	Pulsed Source Current ³		Q1	---	---	86	A
			Q2	---	---	170	A
V _{SD}	Diode Forward Voltage ³	V _{GS} =0V , I _S =1A , T _J =25°C	Q1	---	---	1	V
			Q2	---	---	1	V

Note :

1. Repetitive Rating : Pulsed width limited by maximum junction temperature.
2. V_{DD}=25V, V_{GS}=10V, L=0.1mH, Q1:I_{AS}=30A, Q2:I_{AS}=42A, R_G=25Ω, Starting T_J=25°C.
3. The data tested by pulsed , pulse width ≤ 300us , duty cycle ≤ 2%.
4. Essentially independent of operating temperature.

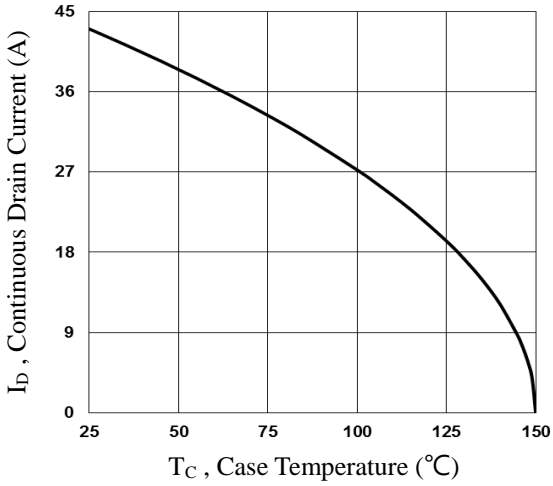

Fig.1 Q1 Continuous Drain Current vs. T_c

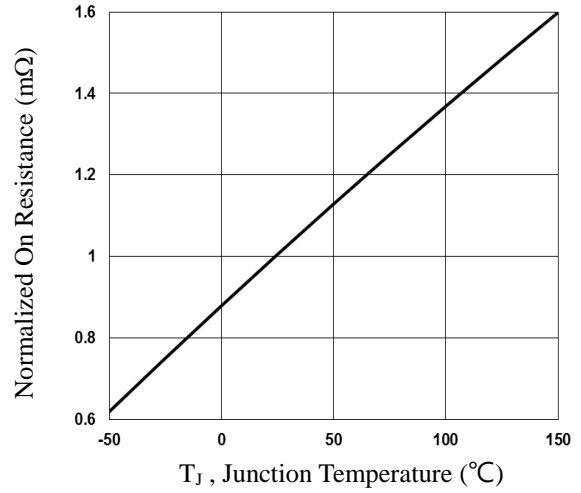

Fig.2 Q1 Normalized R_{DS(on)} vs. T_j

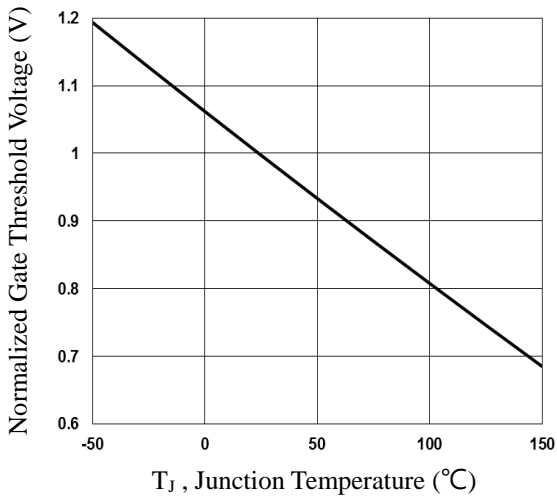

Fig.3 Q1 Normalized V_{th} vs. T_j

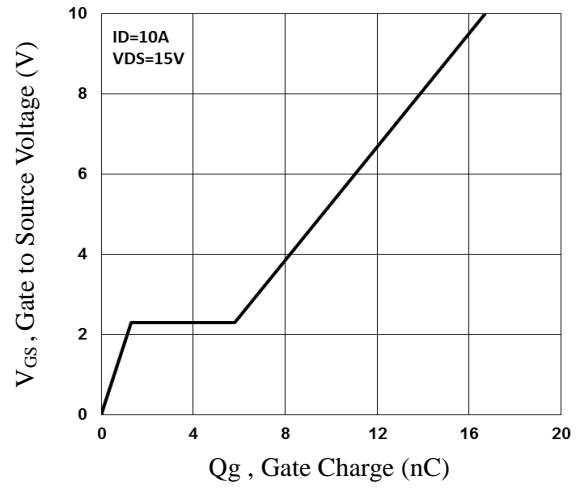

Fig.4 Q1 Gate Charge Waveform

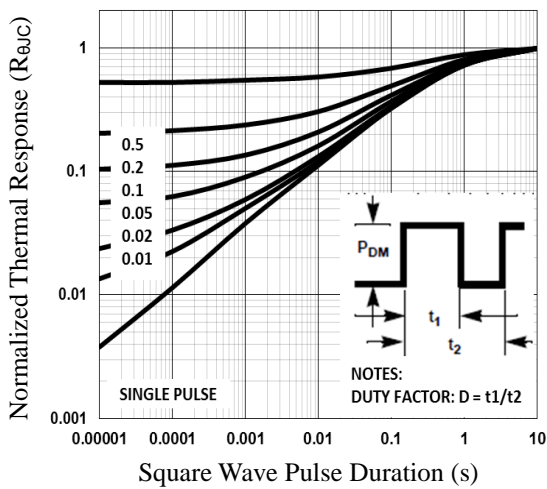

Fig.5 Q1 Normalized Transient Impedance

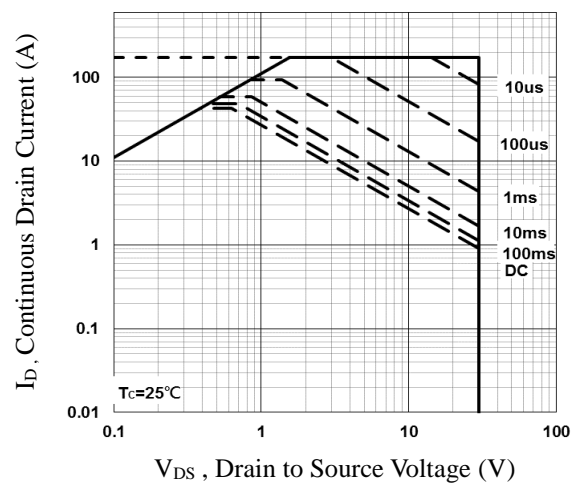

Fig.6 Q1 Maximum Safe Operation Area

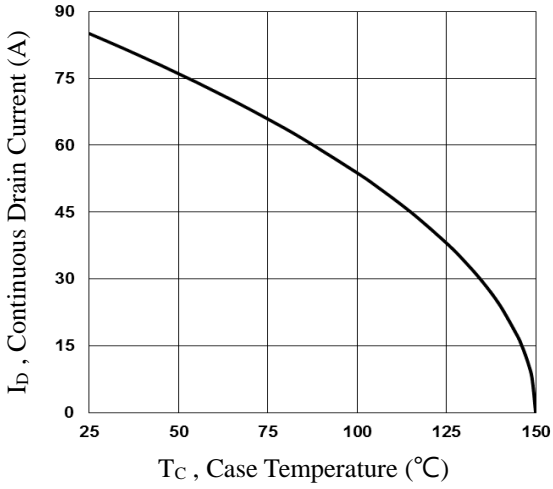

Fig.7 Q2 Continuous Drain Current vs. T_c

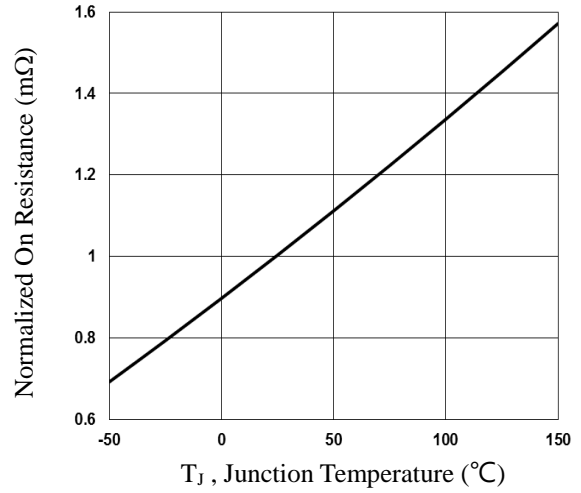

Fig.8 Q2 Normalized R_{DS(on)} vs. T_j

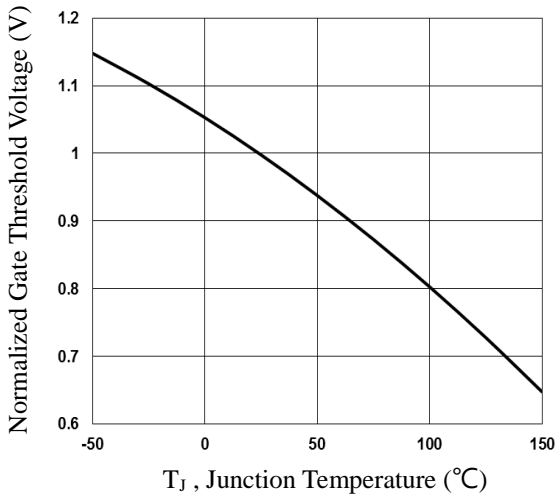

Fig.9 Q2 Normalized V_{th} vs. T_j

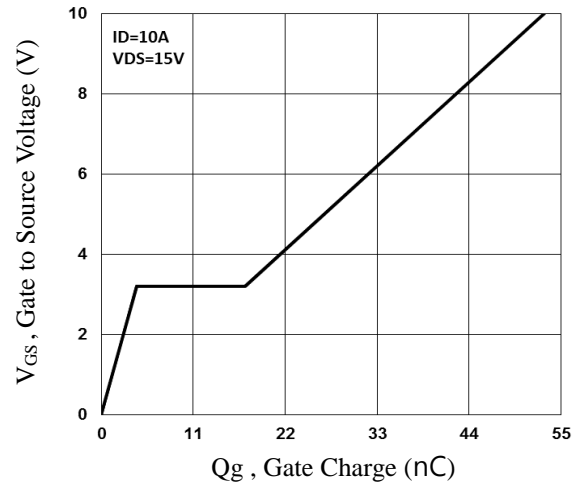

Fig.10 Q2 Gate Charge Waveform

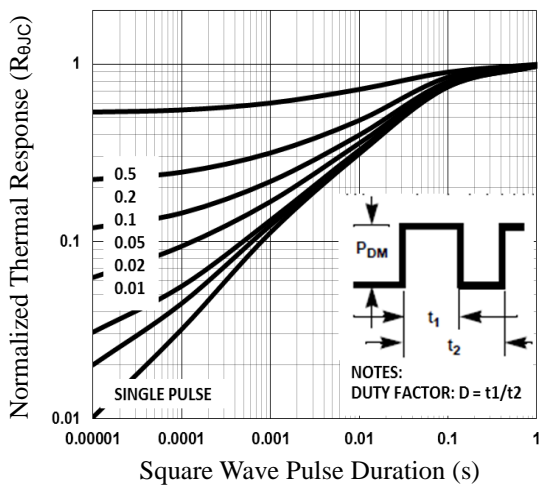

Fig.11 Q2 Normalized Transient Impedance

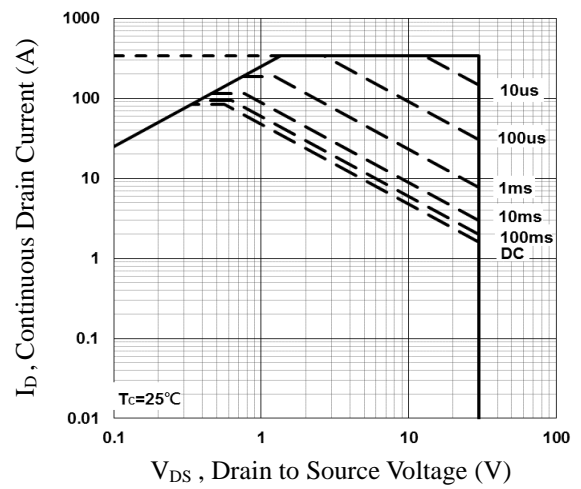

Fig.12 Q2 Maximum Safe Operation Area

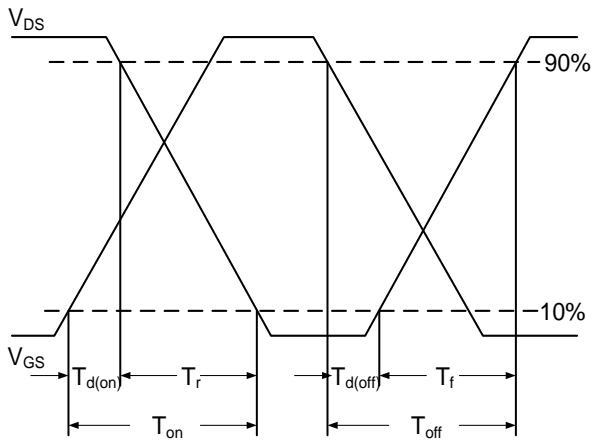

Fig.13 Switching Time Waveform

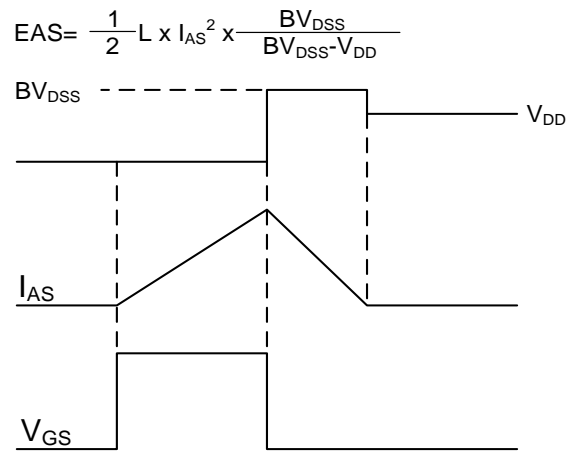
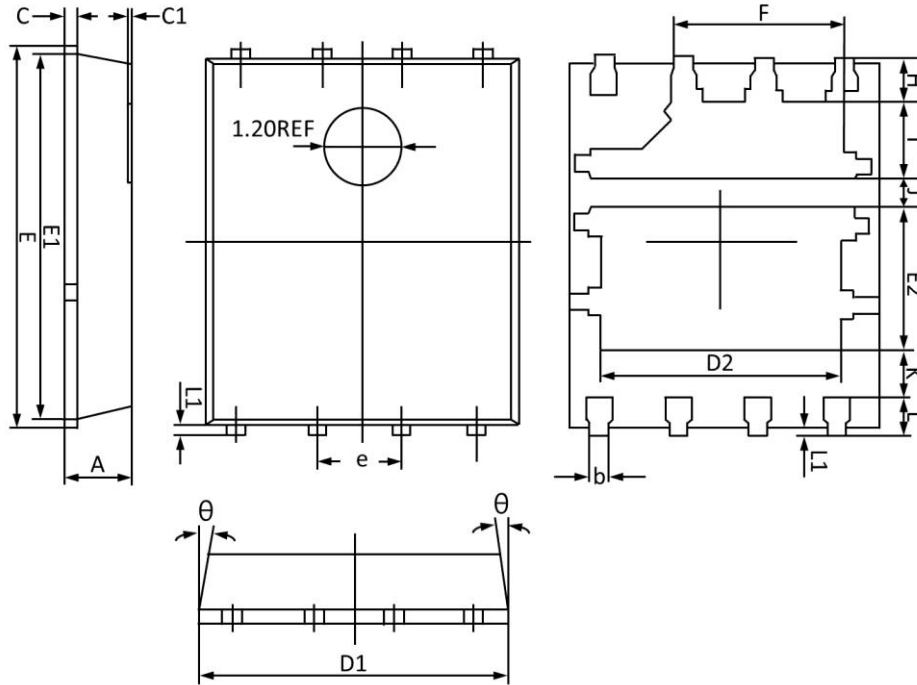

Fig.14 EAS Waveform

$$EAS = \frac{1}{2} L \times I_{AS}^2 \times \frac{BV_{DSS}}{BV_{DSS} - V_{DD}}$$

PPAK5x6 Asymmetric Dual Package Information



Symbol	Dimensions In Millimeters		Dimensions In Inches	
	Min	Max	Min	Max
A	0.900	1.100	0.036	0.043
b	0.330	0.510	0.013	0.020
C	0.200	0.300	0.008	0.011
C1	0.040 REF		0.040 REF	
D1	4.800	5.000	0.189	0.196
D2	3.610	3.960	0.143	0.155
E	5.900	6.100	0.233	0.240
E1	5.700	5.800	0.225	0.228
E2	2.020	2.420	0.080	0.095
e	1.270BSC		1.270BSC	
F	2.550	2.900	0.101	0.114
H	0.610	0.810	0.025	0.031
I	1.100	1.300	0.044	0.051
J	0.400	0.600	0.016	0.023
K	0.500	-	0.020	-
L	0.510	0.710	0.020	0.027
L1	0.060	0.200	0.003	0.007
theta	0°	12°	0°	12°