

### General Description

These P-Channel enhancement mode power field effect transistors are using trench DMOS technology. This advanced technology has been especially tailored to minimize on-state resistance, provide superior switching performance, and withstand high energy pulse in the avalanche and commutation mode. These devices are well suited for high efficiency fast switching applications.

BVDSS	RDSON	ID
-20V	33mΩ	-5.6A

### Features

- -20V, -5.6A,  $R_{DS(ON)} = 33m\Omega$  @  $V_{GS} = -4.5V$
- Improved  $dv/dt$  capability
- Fast switching
- Green Device Available

### PPAK3x3 Dual NEP Pin Configuration

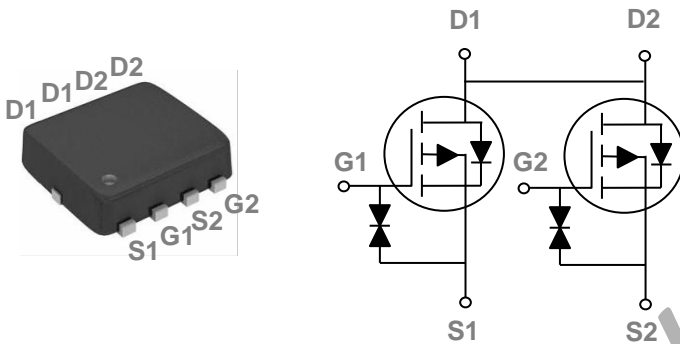

### Applications

- MB / VGA / Vcore
- POL Applications
- Networking

### Absolute Maximum Ratings $T_c=25^\circ C$ unless otherwise noted

Symbol	Parameter	Rating	Units
$V_{DS}$	Drain-Source Voltage	-20	V
$V_{GS}$	Gate-Source Voltage	$\pm 10$	V
$I_D$	Drain Current – Continuous ( $T_A=25^\circ C$ )	5.6	A
	Drain Current – Continuous ( $T_A=70^\circ C$ )	4.5	A
$I_{DM}$	Drain Current – Pulsed <sup>1</sup>	22.4	A
$P_D$	Power Dissipation ( $T_A=25^\circ C$ )	1.67	W
	Power Dissipation – Derate above $25^\circ C$	0.01	W/ $^\circ C$
$T_{STG}$	Storage Temperature Range	-55 to 150	$^\circ C$
$T_J$	Operating Junction Temperature Range	-55 to 150	$^\circ C$

### Thermal Characteristics

Symbol	Parameter	Typ.	Max.	Unit
$R_{\theta JA}$	Thermal Resistance Junction to ambient	---	75	$^\circ C/W$

**Electrical Characteristics (T<sub>J</sub>=25 °C, unless otherwise noted)**
**Off Characteristics**

Symbol	Parameter	Conditions	Min.	Typ.	Max.	Unit
BV <sub>DSS</sub>	Drain-Source Breakdown Voltage	V <sub>GS</sub> =0V, I <sub>D</sub> =-250uA	-20	---	---	V
ΔBV <sub>DSS</sub> /ΔT <sub>J</sub>	BV <sub>DSS</sub> Temperature Coefficient	Reference to 25°C, I <sub>D</sub> =-1mA	---	-0.02	---	V/°C
I <sub>DSS</sub>	Drain-Source Leakage Current	V <sub>DS</sub> =-20V, V <sub>GS</sub> =0V, T <sub>J</sub> =25°C	---	---	-1	uA
		V <sub>DS</sub> =-16V, V <sub>GS</sub> =0V, T <sub>J</sub> =125°C	---	---	-10	uA
I <sub>GSS</sub>	Gate-Source Leakage Current	V <sub>GS</sub> =±10V, V <sub>DS</sub> =0V	---	---	±100	nA

**On Characteristics**

R <sub>DS(ON)</sub>	Static Drain-Source On-Resistance <sup>2</sup>	V <sub>GS</sub> =-4.5V, I <sub>D</sub> =-4A	---	28	33	mΩ
		V <sub>GS</sub> =-2.5V, I <sub>D</sub> =-3A	---	37	45	mΩ
		V <sub>GS</sub> =-1.8V, I <sub>D</sub> =-2A	---	49	65	mΩ
V <sub>GS(th)</sub>	Gate Threshold Voltage	V <sub>GS</sub> =V <sub>DS</sub> , I <sub>D</sub> =-250uA	-0.3	-0.6	-1	V
ΔV <sub>GS(th)</sub>	V <sub>GS(th)</sub> Temperature Coefficient		---	2	---	mV/°C
g <sub>fs</sub>	Forward Transconductance	V <sub>DS</sub> =-10V, I <sub>D</sub> =-3A	---	8.5	---	S

**Dynamic and switching Characteristics**

Q <sub>g</sub>	Total Gate Charge <sup>2, 3</sup>	V <sub>DS</sub> =-10V, V <sub>GS</sub> =-4.5V, I <sub>D</sub> =-4A	---	16.1	25	nC
Q <sub>gs</sub>	Gate-Source Charge <sup>2, 3</sup>		---	1.8	3.6	
Q <sub>gd</sub>	Gate-Drain Charge <sup>2, 3</sup>		---	3.8	7	
T <sub>d(on)</sub>	Turn-On Delay Time <sup>2, 3</sup>	V <sub>DD</sub> =-10V, V <sub>GS</sub> =-4.5V, R <sub>G</sub> =25Ω I <sub>D</sub> =1A	---	8.2	16	ns
T <sub>r</sub>	Rise Time <sup>2, 3</sup>		---	30	57	
T <sub>d(off)</sub>	Turn-Off Delay Time <sup>2, 3</sup>		---	71	135	
T <sub>f</sub>	Fall Time <sup>2, 3</sup>		---	20	38	
C <sub>iss</sub>	Input Capacitance	V <sub>DS</sub> =-15V, V <sub>GS</sub> =0V, F=1MHz	---	1440	2100	pF
C <sub>oss</sub>	Output Capacitance		---	155	230	
C <sub>rss</sub>	Reverse Transfer Capacitance		---	115	170	

**Drain-Source Diode Characteristics and Maximum Ratings**

Symbol	Parameter	Conditions	Min.	Typ.	Max.	Unit
I <sub>S</sub>	Continuous Source Current	V <sub>G</sub> =V <sub>D</sub> =0V, Force Current	---	---	-5.6	A
I <sub>SM</sub>	Pulsed Source Current <sup>2</sup>		---	---	-11.2	A
V <sub>SD</sub>	Diode Forward Voltage <sup>2</sup>	V <sub>GS</sub> =0V, I <sub>S</sub> =-1A, T <sub>J</sub> =25°C	---	---	-1	V

Note :

1. Repetitive Rating : Pulsed width limited by maximum junction temperature.
2. The data tested by pulsed, pulse width ≤ 300us, duty cycle ≤ 2%.
3. Essentially independent of operating temperature.

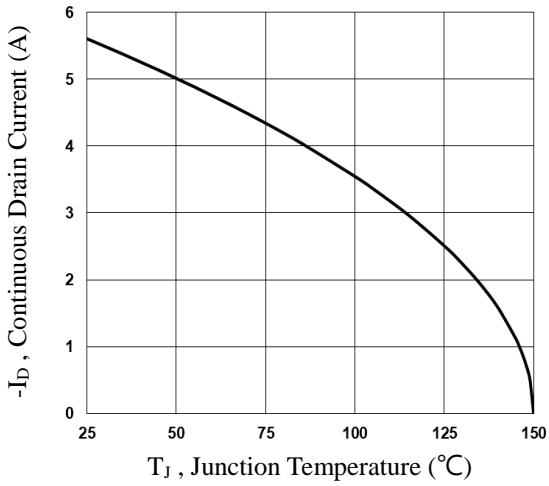

**Fig.1 Continuous Drain Current vs.  $T_c$**

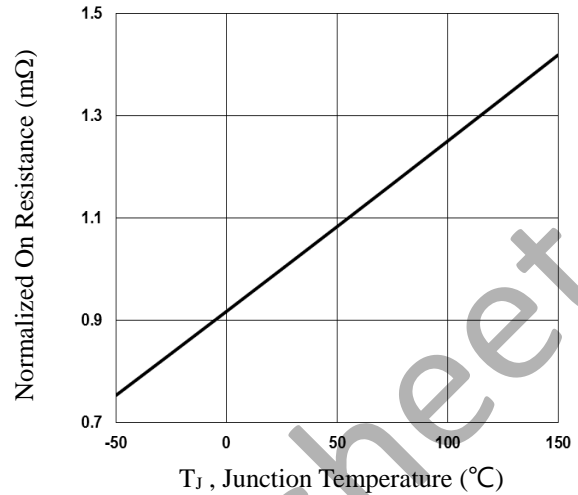

**Fig.2 Normalized RDSON vs.  $T_J$**

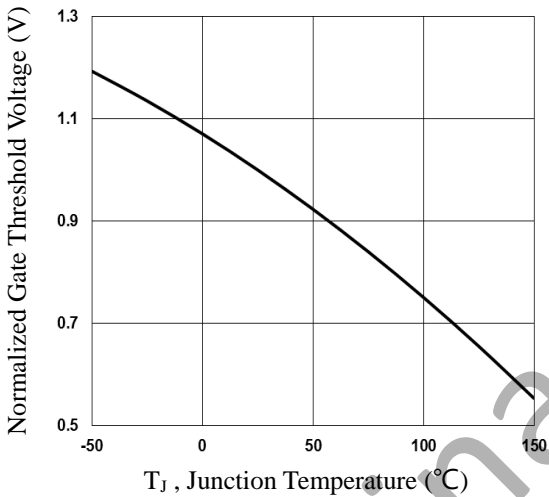

**Fig.3 Normalized  $V_{th}$  vs.  $T_J$**

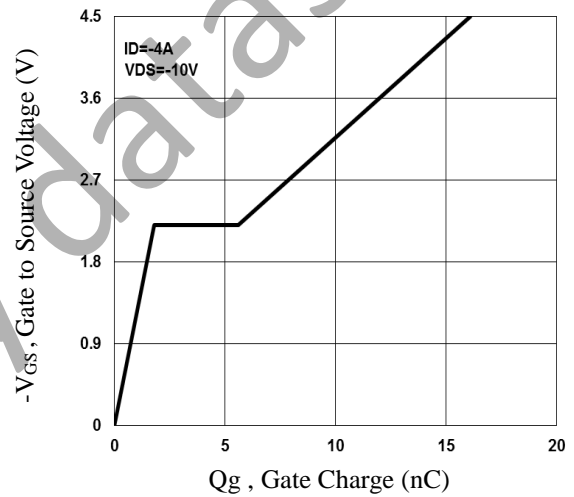

**Fig.4 Gate Charge Waveform**

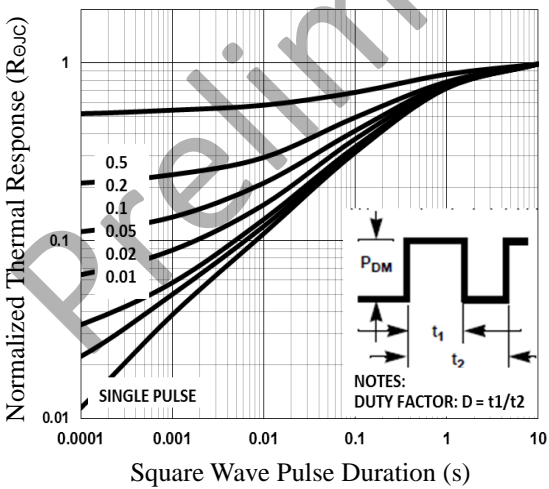

**Fig.5 Normalized Transient Response**

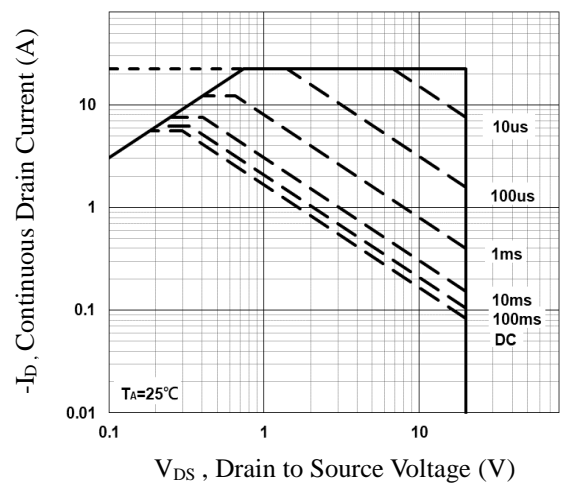

**Fig.6 Maximum Safe Operation Area**

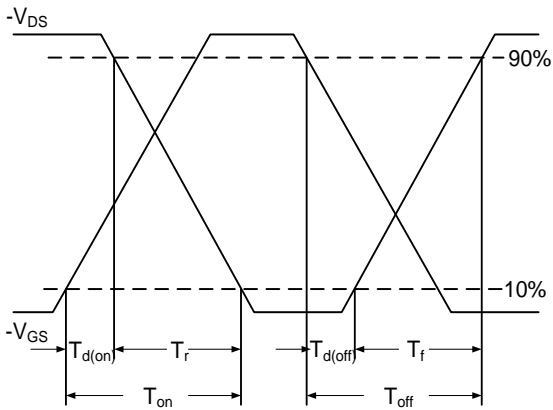

**Fig.7 Switching Time Waveform**

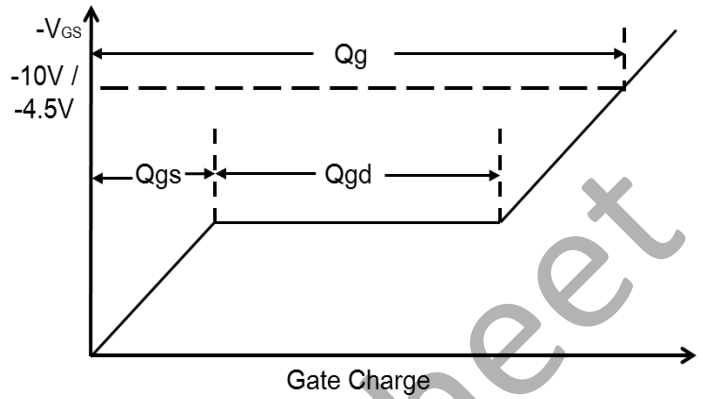

**Fig.8 Gate Charge Waveform**

Preliminary datasheet

PPAK3x3 Dual NEP PACKAGE INFORMATION

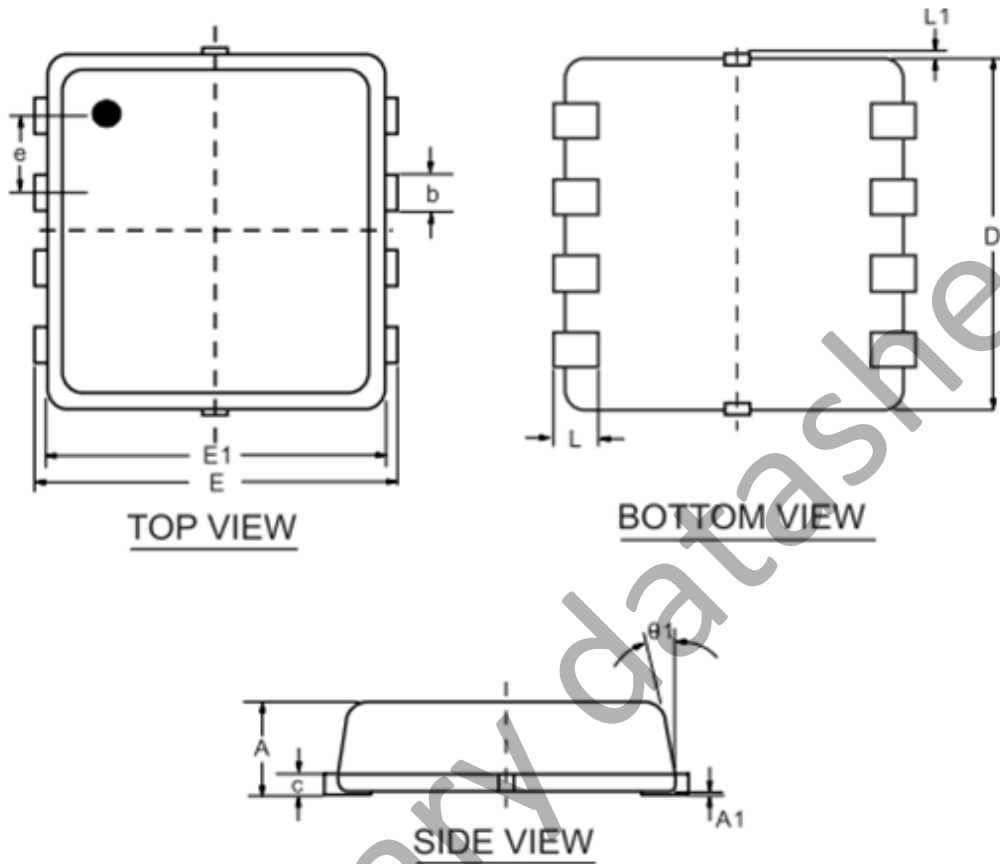

Symbol	Dimensions In Millimeters		
	Min	Typ	Max
A	0.700	0.800	0.900
A1	0.000	---	0.050
b	0.250	0.300	0.350
c	0.080	0.152	0.250
D	2.800	2.900	3.000
E	2.700	2.800	2.900
E1	2.200	2.300	2.400
e	0.65BSC		
L	0.200	0.375	0.450
L1	0.00	---	0.10
$\theta 1$	0°	10°	12°