

### General Description

These N-Channel enhancement mode power field effect transistors are using advanced super junction technology. This advanced technology has been especially tailored to minimize on-state resistance, provide superior switching performance, and withstand high energy pulse in the avalanche and commutation mode. These devices are well suited for high efficiency switch mode power supply

BVDSS	RDSON	ID
650V	2.6Ω	4A

### Features

- Improved dv/dt capability
- Fast switching
- 100% EAS Guaranteed
- Green Device Available

### TO220F Pin Configuration

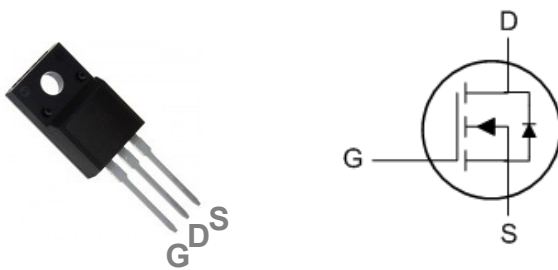

### Applications

- High efficient switched mode power supplies
- TV Power
- Adapter/charger
- Server Power
- PV Inverter / UPS

### Absolute Maximum Ratings $T_c=25^\circ\text{C}$ unless otherwise noted

Symbol	Parameter	Rating	Units
$V_{DS}$	Drain-Source Voltage	650	V
$V_{GS}$	Gate-Source Voltage	$\pm 30$	V
$I_D$	Drain Current – Continuous ( $T_c=25^\circ\text{C}$ )	4	A
	Drain Current – Continuous ( $T_c=100^\circ\text{C}$ )	2.5	A
$I_{DM}$	Drain Current – Pulsed <sup>1</sup>	16	A
EAS	Single Pulse Avalanche Energy <sup>2</sup>	245	mJ
IAS	Single Pulse Avalanche Current <sup>2</sup>	4	A
$P_D$	Power Dissipation ( $T_c=25^\circ\text{C}$ )	28	W
	Power Dissipation – Derate above $25^\circ\text{C}$	0.224	W/ $^\circ\text{C}$
$T_{STG}$	Storage Temperature Range	-55 to 150	$^\circ\text{C}$
$T_J$	Operating Junction Temperature Range	-55 to 150	$^\circ\text{C}$

### Thermal Characteristics

Symbol	Parameter	Typ.	Max.	Unit
$R_{\theta JA}$	Thermal Resistance Junction to ambient	---	62	$^\circ\text{C}/\text{W}$
$R_{\theta JC}$	Thermal Resistance Junction to Case	---	4.4	$^\circ\text{C}/\text{W}$

**Electrical Characteristics ( $T_J=25^\circ\text{C}$ , unless otherwise noted)**
**Off Characteristics**

Symbol	Parameter	Conditions	Min.	Typ.	Max.	Unit
$BV_{DSS}$	Drain-Source Breakdown Voltage	$V_{GS}=0V, I_D=250\mu A$	650	---	---	V
$I_{DSS}$	Drain-Source Leakage Current	$V_{DS}=650V, V_{GS}=0V, T_J=25^\circ\text{C}$	---	---	1	$\mu A$
		$V_{DS}=520V, V_{GS}=0V, T_J=100^\circ\text{C}$	---	---	10	$\mu A$
$I_{GSS}$	Gate-Source Leakage Current	$V_{GS}=\pm 30V, V_{DS}=0V$	---	---	$\pm 100$	nA

**On Characteristics**

$R_{DS(ON)}$	Static Drain-Source On-Resistance	$V_{GS}=10V, I_D=2A$	---	2.2	2.6	$\Omega$
$V_{GS(th)}$	Gate Threshold Voltage	$V_{GS}=V_{DS}, I_D=250\mu A$	2.5	3.5	4.5	V
gfs	Forward Transconductance	$V_{DS}=30V, I_D=2A$	---	4.3	---	S

**Dynamic and switching Characteristics**

$Q_g$	Total Gate Charge <sup>3,4</sup>	$V_{DS}=520V, V_{GS}=10V, I_D=4A$	---	15.4	30	nC
$Q_{gs}$	Gate-Source Charge <sup>3,4</sup>		---	2	4	
$Q_{gd}$	Gate-Drain Charge <sup>3,4</sup>		---	7.3	14	
$T_{d(on)}$	Turn-On Delay Time <sup>3,4</sup>	$V_{DD}=325V, V_{GS}=10V, R_G=10\Omega$ $I_D=4A$	---	15.4	30	ns
$T_r$	Rise Time <sup>3,4</sup>		---	14.8	29	
$T_{d(off)}$	Turn-Off Delay Time <sup>3,4</sup>		---	43.7	65	
$T_f$	Fall Time <sup>3,4</sup>		---	10.5	20	
$C_{iss}$	Input Capacitance	$V_{DS}=25V, V_{GS}=0V, F=1\text{MHz}$	---	518	900	pF
$C_{oss}$	Output Capacitance		---	41.6	80	
$C_{rss}$	Reverse Transfer Capacitance		---	4.5	9	
$R_g$	Gate resistance		$V_{GS}=0V, V_{DS}=0V, F=1\text{MHz}$	---	2.6	

**Drain-Source Diode Characteristics and Maximum Ratings**

Symbol	Parameter	Conditions	Min.	Typ.	Max.	Unit
$I_S$	Continuous Source Current	$V_G=V_D=0V$ , Force Current	---	---	4	A
$I_{SM}$	Pulsed Source Current		---	---	8	A
$V_{SD}$	Diode Forward Voltage	$V_{GS}=0V, I_S=1A, T_J=25^\circ\text{C}$	---	---	1	V
$t_{rr}$	Reverse Recovery Time <sup>3</sup>	$V_{GS}=0V, I_S=4A, dI/dt=100A/\mu s$	---	288	---	nS
$Q_{rr}$	Reverse Recovery Charge <sup>3</sup>	$T_J=25^\circ\text{C}$	---	1.37	---	$\mu C$

**Note :**

1. Repetitive Rating : Pulsed width limited by maximum junction temperature.
2.  $V_{DD}=50V, V_{GS}=10V, L=30mH, I_{AS}=4A, R_G=25\Omega$ , Starting  $T_J=25^\circ\text{C}$ .
3. The data tested by pulsed, pulse width  $\leq 300\mu s$ , duty cycle  $\leq 2\%$ .
4. Essentially independent of operating temperature.

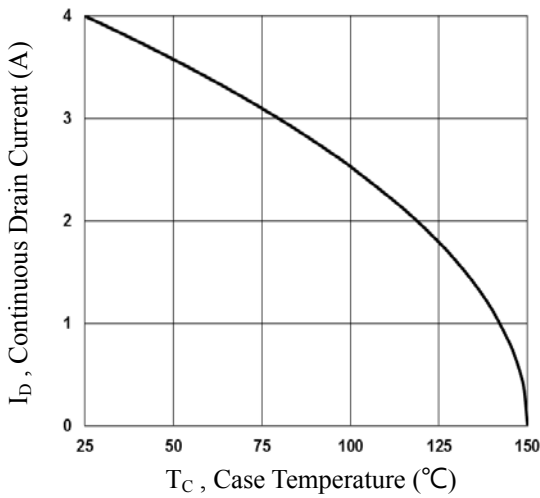

Fig.1 Continuous Drain Current vs.  $T_c$

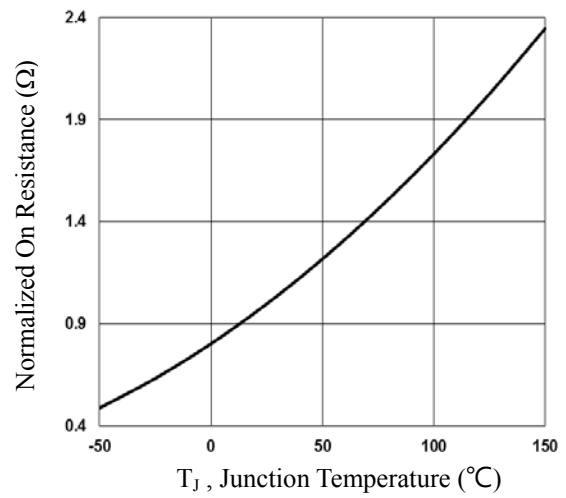

Fig.2 Normalized  $R_{DS(on)}$  vs.  $T_j$

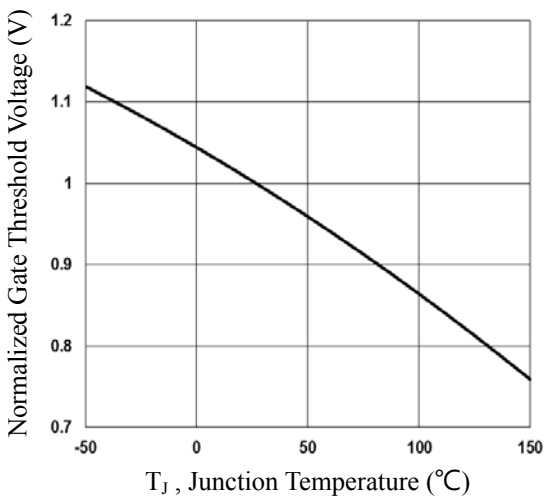

Fig.3 Normalized  $V_{th}$  vs.  $T_j$

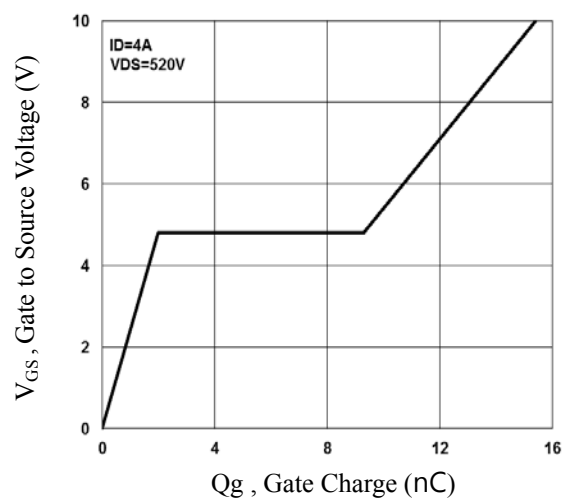

Fig.4 Gate Charge Waveform

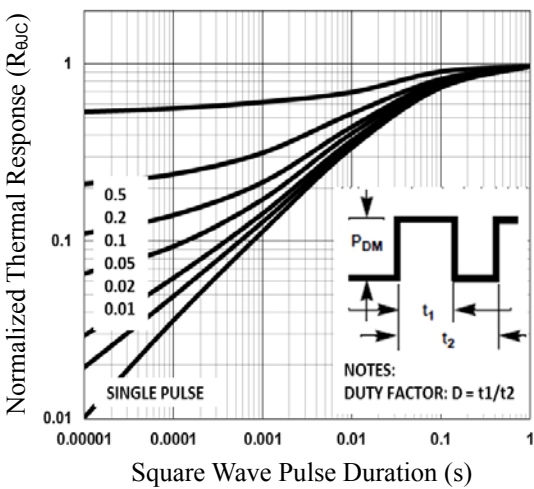

Fig.5 Normalized Transient Impedance

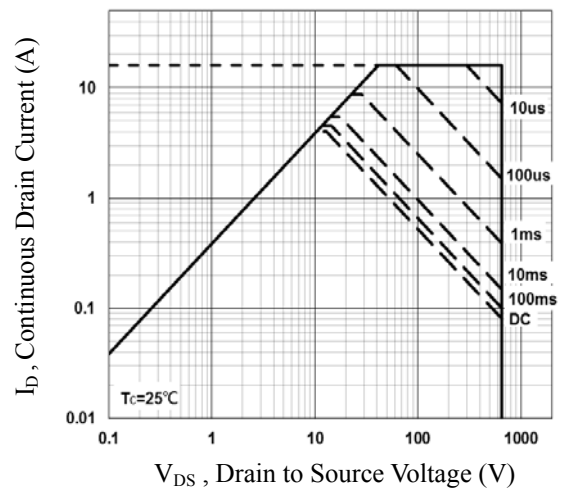

Fig.6 Maximum Safe Operation Area

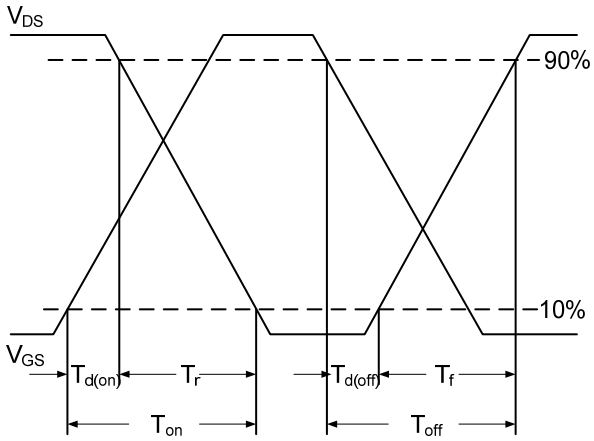

Fig.7 Switching Time Waveform

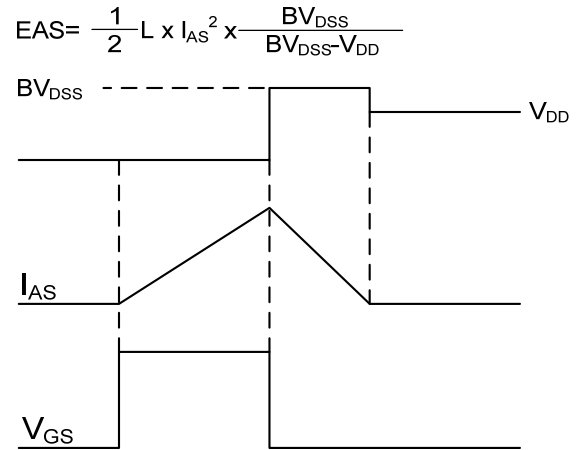
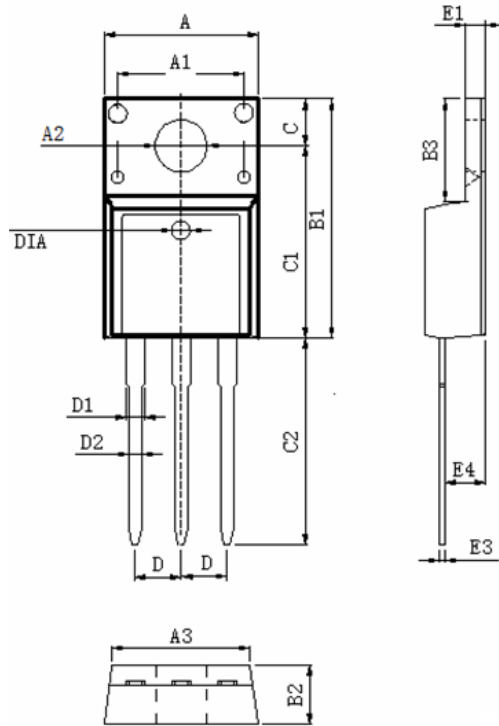

Fig.8 EAS Waveform

## TO220F PACKAGE INFORMATION



Symbol	Dimensions In Millimeters		Dimensions In Inches	
	MAX	MIN	MAX	MIN
A	10.460	9.860	0.412	0.388
A1	7.100	6.900	0.280	0.272
A2	3.500	3.100	0.138	0.122
A3	9.900	9.500	0.390	0.374
B1	16.170	15.570	0.637	0.613
B2	4.900	4.500	0.193	0.177
B3	6.880	6.480	0.271	0.255
C	3.500	3.100	0.138	0.122
C1	12.870	12.270	0.507	0.483
C2	13.380	12.580	0.527	0.495
D	2.590	2.490	0.102	0.098
D1	1.470	1.070	0.058	0.042
D2	0.900	0.700	0.035	0.028
E1	2.740	2.340	0.108	0.092
E3	0.600	0.400	0.024	0.016
E4	2.960	2.560	0.117	0.101
DIA	Φ1.5 TYP.	deep0.1 TYP.	Φ0.059 TYP.	deep0.004 TYP.