

# COMMON MODE CHOKE CATALOG

Suited for LAN and Telecom Applications



## *TABLE of CONTENTS*

### **Common Mode Chokes for Datacom Applications**

Surface Mount Common Mode Chokes .....2-6

Through Hole Common Mode Chokes .....7-12

# SURFACE MOUNT COMMON MODE CHOKES

## Suited for LAN and Telecom Applications

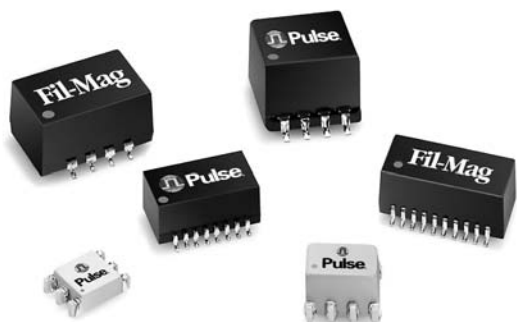

- Reduces radiated EMI emissions
- Filters common mode noise for EMI reduction
- Common mode attenuation from 100 kHz to 1 GHz
- Tape & Reel packaging available for surface mount parts\*

### Electrical Specifications @ 25°C

Part Number	No. of Lines	Primary Inductance OCL (µH MIN)	Common Mode Attenuation (dB TYP)										DCR (Ω MAX)	Page Number of Mech. & Schem.
			100 KHz	1 MHz	10 MHz	30 MHz	50 MHz	100 MHz	300 MHz	500 MHz	1 GHz			
PE-68624	2	47	11	27	40	44	42	36	26	17	—	0.40	2	
PE-65855	2	4700	41	43	49	39	34	26	20	20	12	1.0	4	
B2013	2	6300	46	47	43	32	25	29	21	14	16	1.0	3	
B4003	2	4700	42	41	48	38	33	21	22	23	17	1.0	6	
R0003	3	20	6	14	27	30	30	30	30	28	25	0.40	2	
23Z87SM	3	69	9	24	31	30	29	27	21	16	—	0.20	4	
PE-65857	4	22.5	7	20	30	37	38	34	24	13	—	0.22	4	
PE-68627	4	24	8	21	32	36	37	36	30	20	—	0.25	4	
T8003	4	33	9	13	32	32	30	27	16	17	13	0.20	6	
23Z4000SMD	4	36	7	23	35	38	38	36	29	24	—	0.50	5	
PE-65738	4	37	8	21	28	28	28	27	25	22	—	0.30	3	
PE-65854	4	47	3	19	32	36	35	29	12	6	—	0.40	3	
23Z104SM	4	68	8	22	28	28	27	25	20	15	—	0.20	5	
PE-67540	4	100	14	33	44	48	49	44	34	29	20	0.60	4	
PE-65853	4	4700	40	51	38	30	25	20	14	13	—	1.20	3	
PE-68602	6	21	6	19	28	34	35	36	34	29	1	0.35	3	
23Z106SM	6	68	8	22	29	30	30	29	24	19	—	0.20	5	
PE-69011	8	36	8	24	36	39	35	29	18	11	—	0.35	3	
23Z105SM	8	68	8	24	30	29	27	24	16	11	—	0.20	5	
23Z109SM	10	7.5	4	9	20	25	26	24	16	11	—	0.20	5	
T8008	16	47	7	27	40	44	42	36	26	—	—	0.40	6	

\* When ordering Tape & Reel packaging, add a "T" at the end of the part number (i.e. PE-65738T or 23Z106SMT).

**NOTE:** Additional common mode chokes are available. Please contact Applications Engineering.

## Mechanicals

## Schematics

### PE-68624, R0003

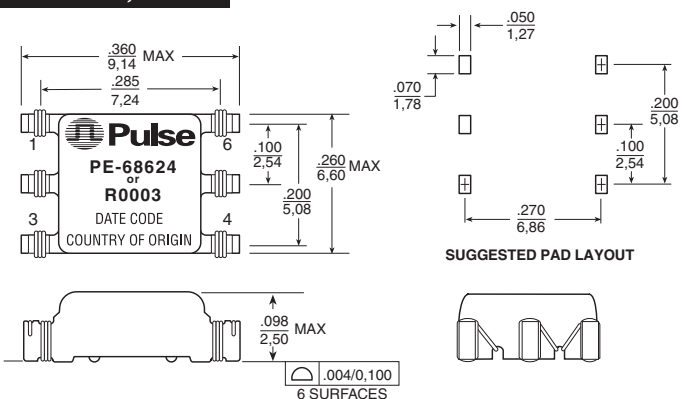

Weight ..... .0.17 grams  
Tape & Reel ..... .1500/reel  
Tube ..... .60/tube

### R0003



Connect unused pin to logic ground for optimum performance.

### PE-68624



# SURFACE MOUNT COMMON MODE CHOKES

## Suited for LAN and Telecom Applications



### Mechanicals

### Schematics

#### PE-65738, PE-68602, PE-69011

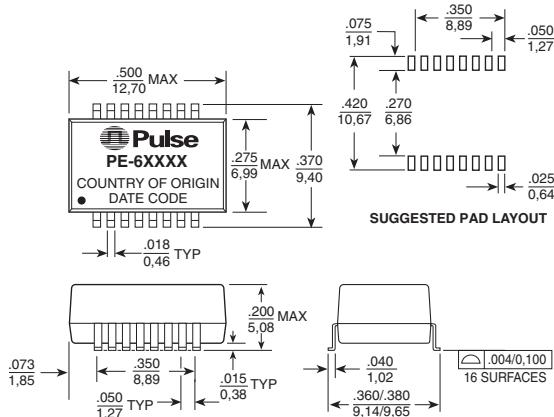

**Dimensions:**  $\frac{\text{Inches}}{\text{mm}}$   
Unless otherwise specified,  
all tolerances are  $\pm \frac{.010}{0.25}$

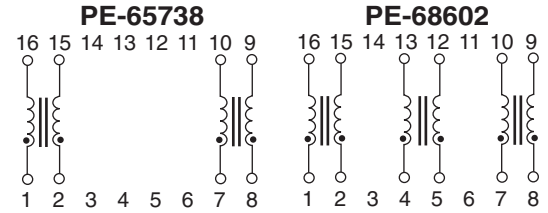

**Weight** . . . . .0.83 grams  
**Tape & Reel** . . . . .900/reel  
**Tube** . . . . .40/tube

#### PE-69011

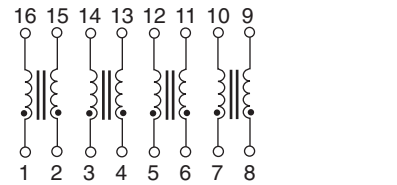

#### PE-65853

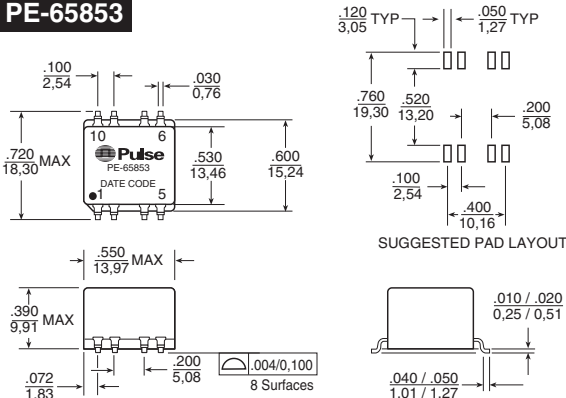

**Dimensions:**  $\frac{\text{Inches}}{\text{mm}}$   
Unless otherwise specified,  
all tolerances are  $\pm \frac{.010}{0.25}$

**Weight** . . . . .4.0 grams  
**Tape & Reel** . . . . .150/reel  
**Tube** . . . . .35/tube

#### PE-65853

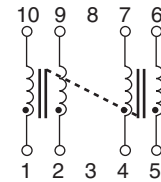

#### B2013

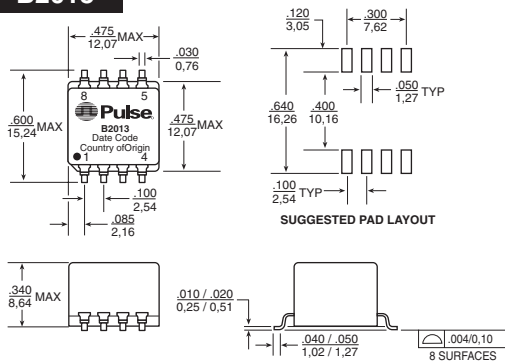

**Dimensions:**  $\frac{\text{Inches}}{\text{mm}}$   
Unless otherwise specified,  
all tolerances are  $\pm \frac{.010}{0.25}$

**Weight** . . . . .9.5 grams  
**Tray** . . . . .30/tray

#### B2013



#### PE-65854

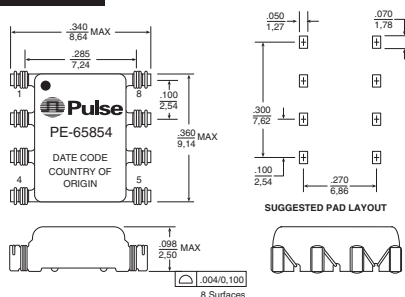

**Dimensions:**  $\frac{\text{Inches}}{\text{mm}}$   
Unless otherwise specified,  
all tolerances are  $\pm \frac{.010}{0.25}$

**Weight** . . . . .0.3 grams  
**Tape & Reel** . . . . .1500/reel  
**Tube** . . . . .60/tube

#### PE-65854

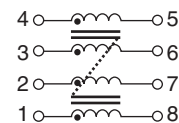

# SURFACE MOUNT COMMON MODE CHOKES

## Suited for LAN and Telecom Applications



### Mechanicals

### Schematics

#### PE-65855

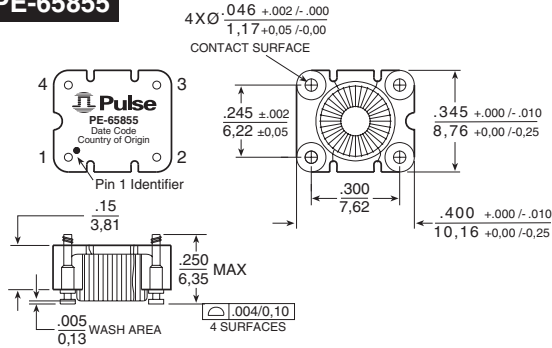

**Dimensions:** Inches  
mm  
Unless otherwise specified,  
all tolerances are  $\pm .010$   
 $0,25$

**Weight** ..... 0.69 grams  
**Tape & Reel** ..... .800/reel  
**Tube** ..... .40 /tube

#### PE-65855



#### PE-65857, PE-67540

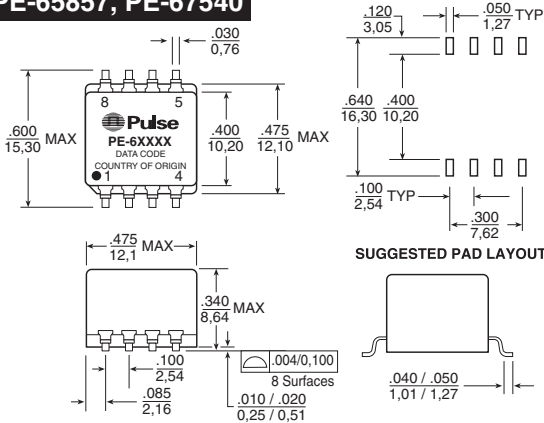

**Dimensions:** Inches  
mm  
Unless otherwise specified,  
all tolerances are  $\pm .010$   
 $0,25$

**Weight** ..... 2.0 grams  
**Tape & Reel** ..... .250/reel  
**Tube** ..... .40 /tube

#### PE-65857

#### PE-67540

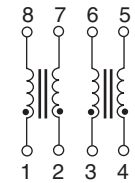
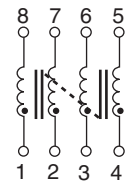

#### PE-68627

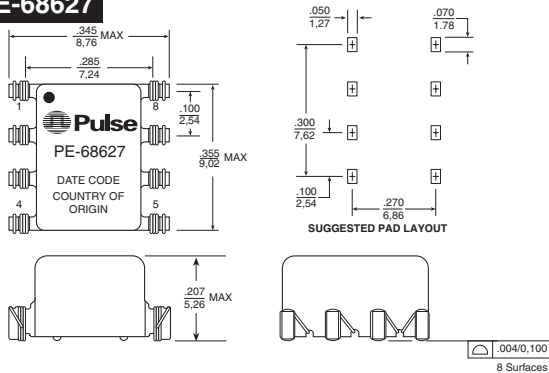

**Dimensions:** Inches  
mm  
Unless otherwise specified,  
all tolerances are  $\pm .010$   
 $0,25$

**Weight** ..... 0.3 grams  
**Tape & Reel** ..... .1500/reel  
**Tube** ..... .55 /tube

#### PE-68627

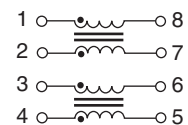

#### 23Z87SM

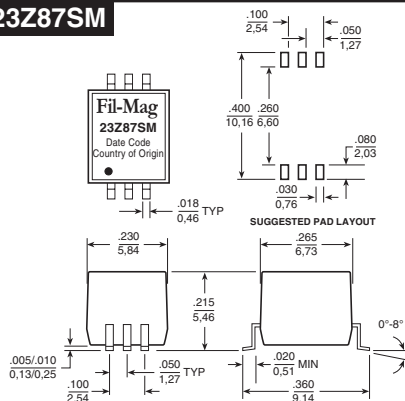

**Dimensions:** Inches  
mm  
Unless otherwise specified,  
all tolerances are  $\pm .005$   
 $0,13$

**Weight** ..... 0.5 grams  
**Tape & Reel** ..... .750/reel  
**Tube** ..... 100/tube

#### 23Z87SM



# SURFACE MOUNT COMMON MODE CHOKES

Suited for LAN and Telecom Applications



## Mechanicals

## Schematics

### 23Z104SM

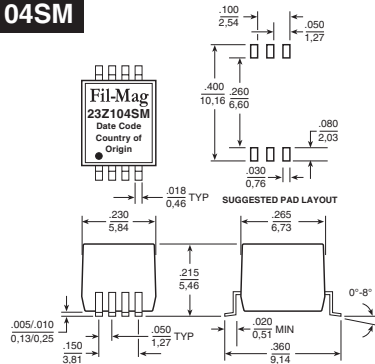

**Dimensions:** Inches  
mm  
Unless otherwise specified,  
all tolerances are  $\pm .005$   
0,13

**Weight** ..... 0.5 grams  
**Tape & Reel** ..... .750/reel  
**Tube** ..... 100/tube

### 23Z104SM

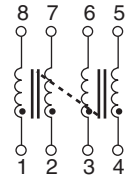

### 23Z105SM, 23Z106SM

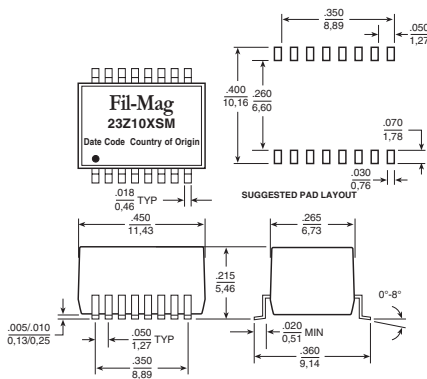

**Dimensions:** Inches  
mm  
Unless otherwise specified,  
all tolerances are  $\pm .005$   
0,13

**23Z105SM**    **23Z106SM**  
**Weight** ..... 0.8 grams ..... 1.0 grams  
**Tape & Reel** ..... .750/reel ..... .750/reel  
**Tube** ..... .50/tube ..... .50/tube

### 23Z105SM

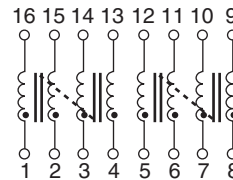

### 23Z106SM

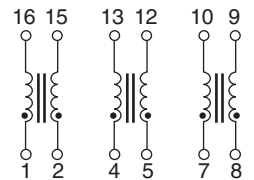

### 23Z109SM

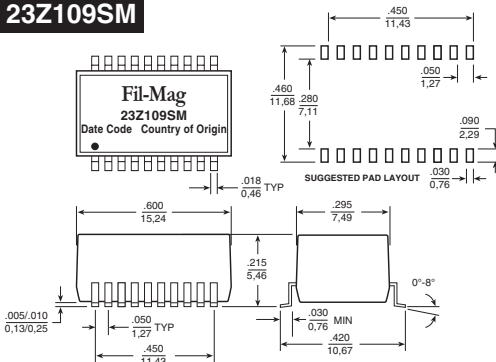

**Dimensions:** Inches  
mm  
Unless otherwise specified,  
all tolerances are  $\pm .005$   
0,13

**Weight** ..... 1.3 grams  
**Tape & Reel** ..... .500/reel  
**Tube** ..... .38/tube

### 23Z109SM

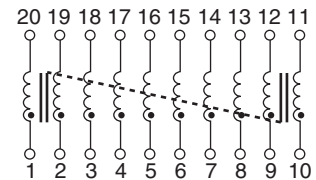

### 23Z4000SMD

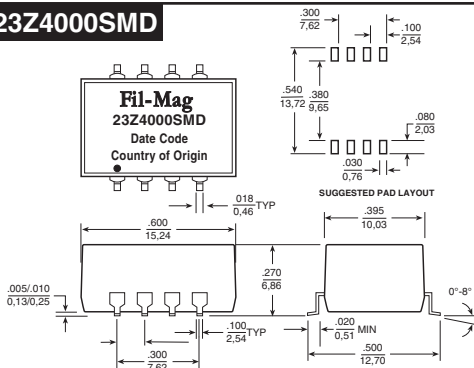

**Dimensions:** Inches  
mm  
Unless otherwise specified,  
all tolerances are  $\pm .005$   
0,13

**Weight** ..... 2.1 grams  
**Tape & Reel** ..... .350/reel  
**Tube** ..... .38/tube

### 23Z4000SMD

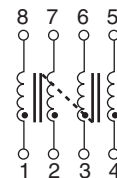

# SURFACE MOUNT COMMON MODE CHOKES

## Suited for LAN and Telecom Applications



### Mechanicals

### Schematics

#### T8003

#### T8003

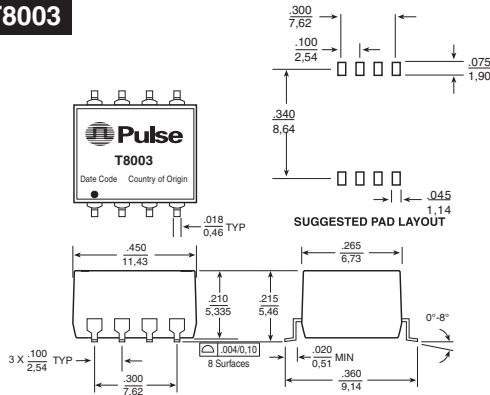

**Dimensions:**  $\frac{\text{Inches}}{\text{mm}}$   
Unless otherwise specified,  
all tolerances are  $\pm \frac{.005}{0,13}$

**Weight** ..... 0.84 grams  
**Tape & Reel** ..... .750/reel  
**Tube** ..... 100/tube

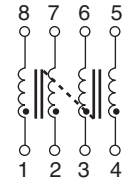

#### T8055

#### T8055

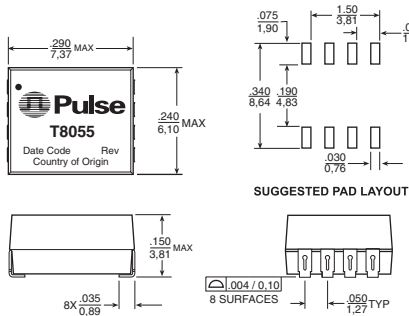

**Dimensions:**  $\frac{\text{Inches}}{\text{mm}}$   
Unless otherwise specified,  
all tolerances are  $\pm \frac{.010}{0,25}$

**Weight** ..... 0.2 grams  
**Tape & Reel** ..... .1750/reel  
**Tube** ..... .80/tube

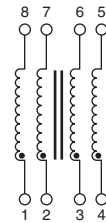

#### B4003

#### B4003

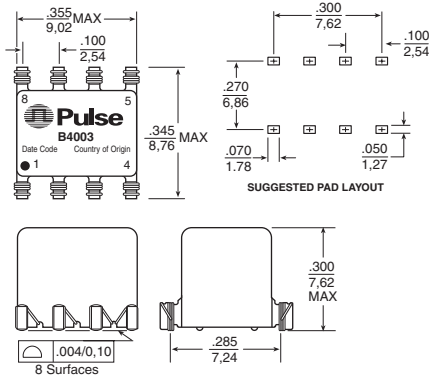

**Dimensions:**  $\frac{\text{Inches}}{\text{mm}}$   
Unless otherwise specified,  
all tolerances are  $\pm \frac{.010}{0,25}$

**Weight** ..... 1.0 grams  
**Tape & Reel** ..... .425/reel  
**Tube** ..... .50/tube

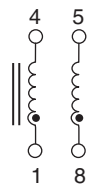

#### T8008

#### T8008

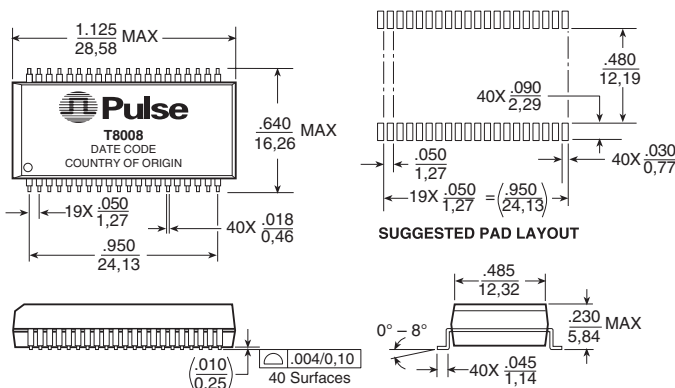

**Dimensions:**  $\frac{\text{Inches}}{\text{mm}}$   
Unless otherwise specified,  
all tolerances are  $\pm \frac{.010}{0,25}$

**Weight** ..... 4.0 grams  
**Tape & Reel** ..... .250/reel  
**Tube** ..... .15/tube

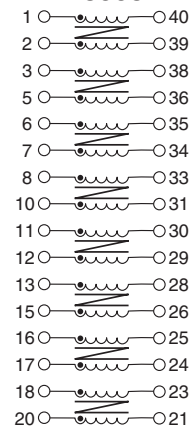



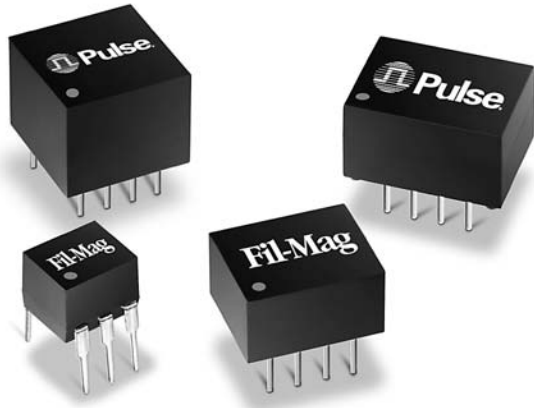

**NOTE:** The common mode test circuit for surface mount is the same as for through hole and is on the back page.

# THROUGH HOLE COMMON MODE CHOKES

## Suited for LAN and Telecom Applications



-  Reduces radiated EMI emissions
-  Filters common mode noise for EMI reduction
-  Common mode attenuation from 100 KHz to 1 GHz
-  Tube packaging available for through hole parts

### Electrical Specifications @ 25°C

Part Number	No. of Lines	Primary Inductance OCL (μH MIN)	Common Mode Attenuation (dB TYP)									DCR (Ω MAX)	Page Number of Mech. & Schem.
			100 KHz	1 MHz	10 MHz	30 MHz	50 MHz	100 MHz	300 MHz	500 MHz	1 GHz		
PE-65944	2	24	1	14	28	32	33	28	13	5	—	0.30	9
23Z107	2	68	8	25	33	32	30	27	18	12	—	0.20	10
PE-67531	2	140	14	34	45	49	50	47	38	32	25	0.60	9
B2005	2	9000	47	47	41	30	22	33	21	15	15	1.0	10
PE-65554	4	24	—	21	32	38	39	34	24	13	—	0.30	8
42Z4000	4	36	8	24	37	40	40	38	30	24	—	0.20	10
PE-67501	4	50	14	34	45	49	50	47	20	15	10	0.30	9
PE-68002	4	68	7	24	37	41	42	40	31	27	—	0.35	9
23Z104	4	85	8	23	29	29	28	25	17	11	—	0.20	10
PE-67539	4	140	14	33	44	48	48	43	33	28	19	0.60	9
PE-65542	4	1000	28	41	42	32	22	—	—	—	—	0.70	8
PT5039	4	3600	42	43	42	32	27	17	15	9	13	0.50	8
J0010D11	4	—	9	13	32	35	35	29	13	24	19	0.50	11
PE-65950	4	4700±30%	40	51	37	28	23	20	—	—	—	1.00	8
PE-65541	4	6000	44	54	33	32	29	—	—	—	—	1.40	8
PE-68613	4	3290	40	51	37	28	23	20	—	—	—	1.00	11
PE-64683	6	25	6	18	32	38	37	32	21	17	—	0.35	8

# THROUGH HOLE COMMON MODE CHOKES

Suited for LAN and Telecom Applications



## Mechanicals

## Schematics

### PE-64683

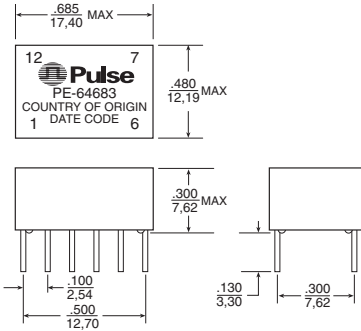

### PE-64683

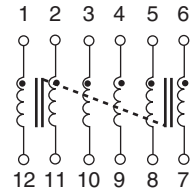

**Dimensions:** Inches  
mm  
Unless otherwise specified,  
all tolerances are  $\pm \frac{.010}{0,25}$

**Weight** .....0.27 grams  
**Tube** .....30/tube

### PE-65541, PE-65542, PE-65950

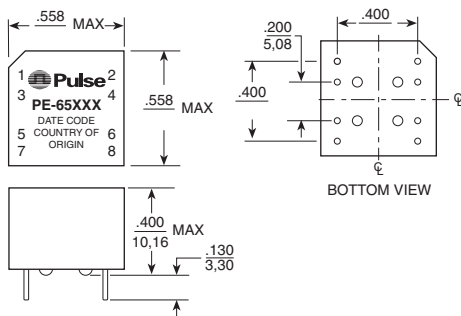

### PE-65541 PE-65542 PE-65950

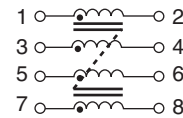

**Dimensions:** Inches  
mm  
Unless otherwise specified,  
all tolerances are  $\pm \frac{.010}{0,25}$

**Weight** .....0.38 grams  
**Tube** .....35/tube

### PE-65554

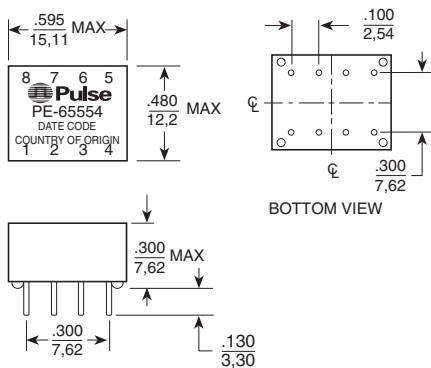

### PE-65554

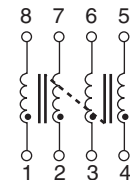

**Dimensions:** Inches  
mm  
Unless otherwise specified,  
all tolerances are  $\pm \frac{.010}{0,25}$

**Weight** .....2.5 grams  
**Tube** .....35/tube

### PT5039

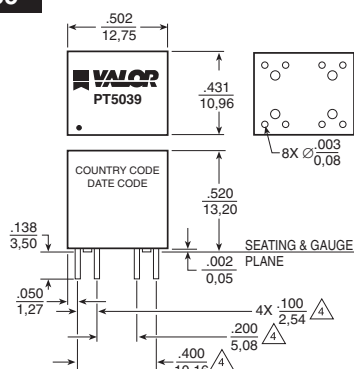

### PT5039

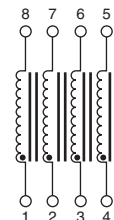

**Dimensions:** Inches  
mm  
Unless otherwise specified,  
all tolerances are  $\pm \frac{.010}{0,25}$

**Weight** .....2.5 grams  
**Tube** .....35/tube



# THROUGH HOLE COMMON MODE CHOKES

Suited for LAN and Telecom Applications



**Pulse**  
A TECHNITROL COMPANY

## Mechanicals

## Schematics

### PE-65944

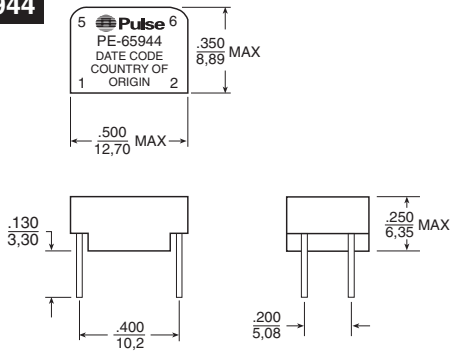

Dimensions:  $\frac{\text{Inches}}{\text{mm}}$   
Unless otherwise specified,  
all tolerances are  $\pm \frac{.010}{0,25}$

### PE-65944



Weight .....1.07 grams  
Tube ..... .30/tube

### PE-67501, PE-67539

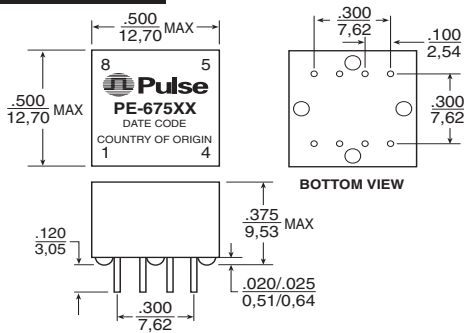

Dimensions:  $\frac{\text{Inches}}{\text{mm}}$   
Unless otherwise specified,  
all tolerances are  $\pm \frac{.010}{0,25}$

### PE-67501 PE-67539

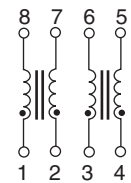

Weight .....2.4 grams  
Tube ..... .40/tube

### PE-67531

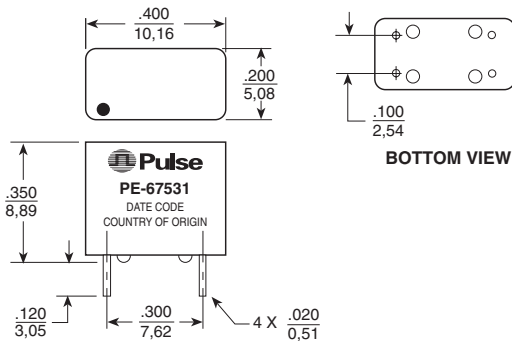

Dimensions:  $\frac{\text{Inches}}{\text{mm}}$   
Unless otherwise specified,  
all tolerances are  $\pm \frac{.010}{0,25}$

### PE-67531



Weight .....0.76 grams  
Tube ..... .40/tube

### PE-68002

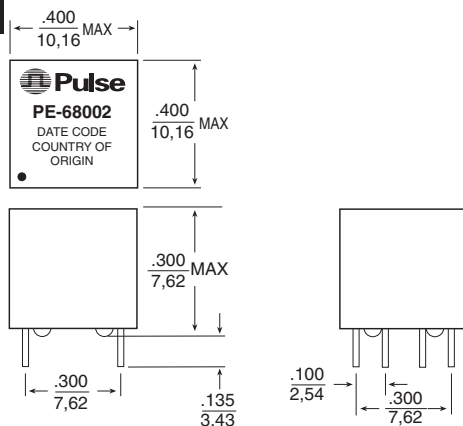

Dimensions:  $\frac{\text{Inches}}{\text{mm}}$   
Unless otherwise specified,  
all tolerances are  $\pm \frac{.010}{0,25}$

### PE-68002

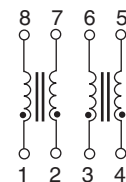

Weight .....1.4 grams  
Tube ..... .50/tube

# THROUGH HOLE COMMON MODE CHOKES

Suited for LAN and Telecom Applications



## Mechanicals

## Schematics

**B2005**

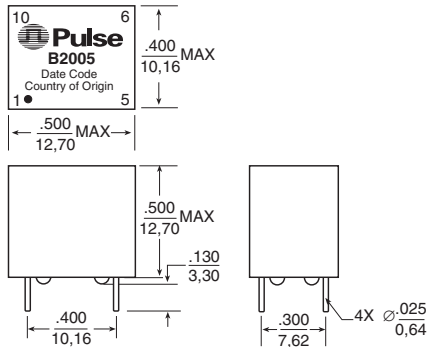

**Dimensions:** Inches  
mm  
Unless otherwise specified,  
all tolerances are ± .005  
0,13

**Weight** ..... 3.7 grams  
**Tube** ..... .40/tube



**23Z104**

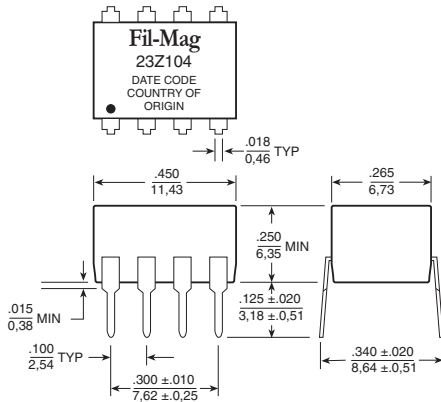

**Dimensions:** Inches  
mm  
Unless otherwise specified,  
all tolerances are ± .005  
0,13

**Weight** ..... 1.0 grams  
**Tube** ..... .50/tube

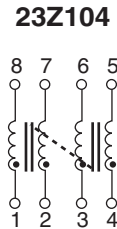

**23Z107**

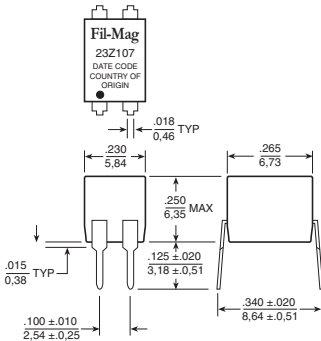

**Dimensions:** Inches  
mm  
Unless otherwise specified,  
all tolerances are ± .005  
0,13

**Weight** ..... 0.45 grams  
**Tube** ..... .100/tube

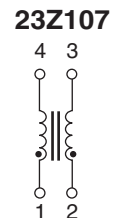

**42Z4000**

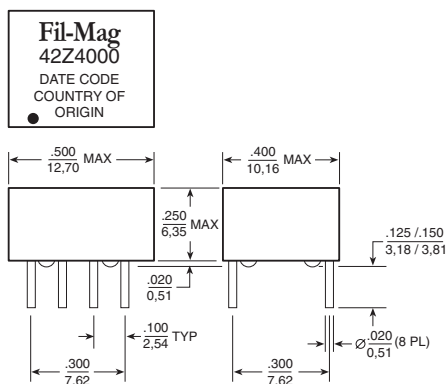

**Dimensions:** Inches  
mm  
Unless otherwise specified,  
all tolerances are ± .010  
0,25

**Weight** ..... 1.5 grams  
**Tube** ..... .47/tube

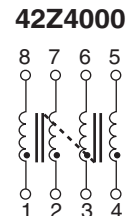

# THROUGH HOLE COMMON MODE CHOKES

Suited for LAN and Telecom Applications



**Pulse**  
A TECHNITROL COMPANY

## Mechanicals

## Schematics

### PE-68613

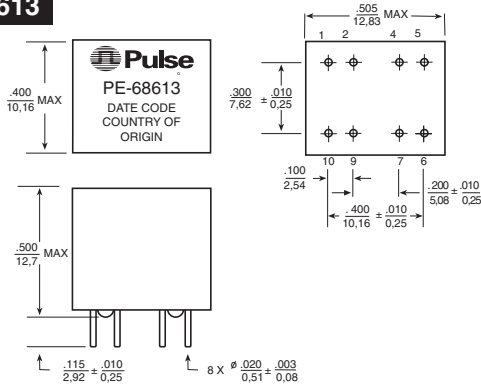

Dimensions: Inches  
mm  
Unless otherwise specified,  
all tolerances are ± .005  
0,127

Weight ..... 3.5 grams  
Tube ..... .40/tube

### PE-68613

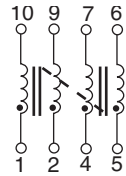

### J0010D11 - Filtered Connector

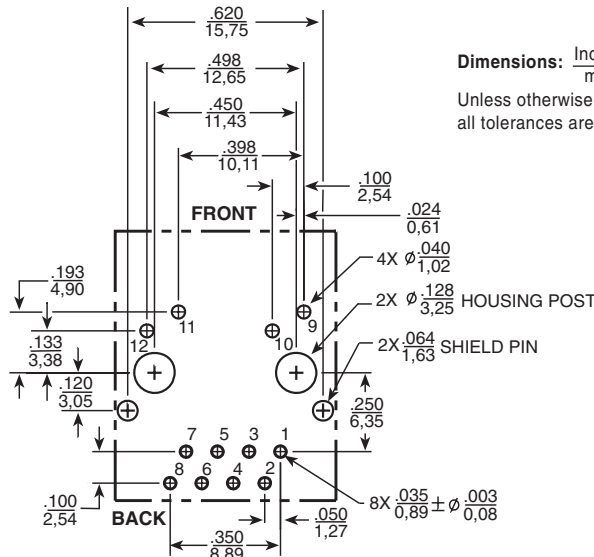
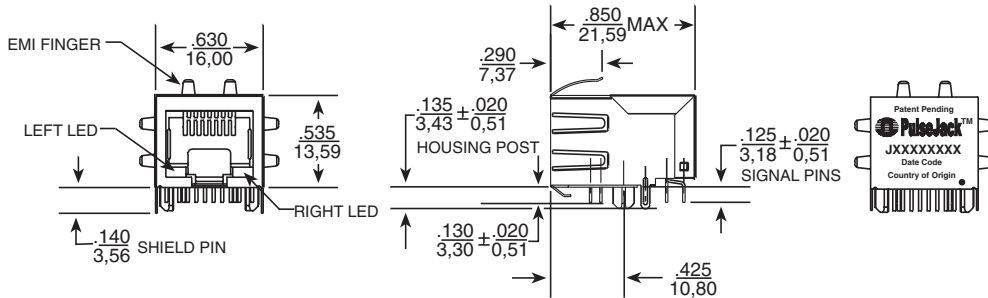

Dimensions: Inches  
mm  
Unless otherwise specified,  
all tolerances are ± .010  
0,25

# THROUGH HOLE COMMON MODE CHOKES

## Suited for LAN and Telecom Applications



### Common Mode Test Circuit for Surface Mount and Through Hole

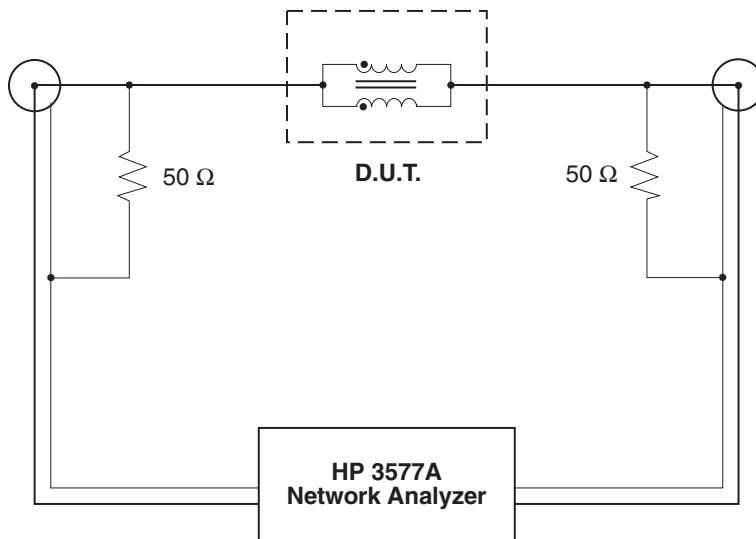

#### Test Notes:

1. Network analyzer calibrated to compensate for 50  $\Omega$  resistors.
2. All windings on a core are connected in parallel for the test.
3. For multi-core chokes, test data is for one core only. The windings on the other core(s) are left unconnected (i.e. open).

#### For More Information:

##### Pulse Worldwide Headquarters

12220 World Trade Dr.  
San Diego, CA 92128  
U.S.A.

[www.pulseeng.com](http://www.pulseeng.com)

##### Pulse European Headquarters

Einsteinstrasse 1  
71083 Herrenberg  
Germany

##### Pulse China Headquarters

B402, Shenzhen  
Tech-Innovation International  
10th Kejinan Rd.  
High-Tech Industrial Park  
Nanshan District, Shenzhen  
China

##### Pulse North China

Room 1503  
XinYin Building  
No. 888 YiShan Road  
Shanghai 200233  
China

##### Pulse South Asia

150 Kampong Ampat  
#07-01/02  
KA Centre  
Singapore 368324

##### Pulse North Asia

No. 26  
Kao Ching Road  
Yang Mei Chen  
Taoyuan Hsien  
Taiwan, R. O. C.

TEL: 858 674 8100

FAX: 858 674 8262

TEL: 49 7032 7806 0

FAX: 49 7032 7806 12

TEL: 86 755 33966678

FAX: 86 755 33966700

TEL: 86 21 54643211/2

FAX: 86 21 54643210

TEL: 65 6287 8998

FAX: 65 6280 0080

TEL: 886 3 4641811

FAX: 886 3 4641911

Performance warranty of products offered on this data sheet is limited to the parameters specified. Data is subject to change without notice. Other brand and product names mentioned herein may be trademarks or registered trademarks of their respective owners.

© Copyright, 2007. Pulse Engineering, Inc. All rights reserved.