

DIODE MODULE 150A/800V

PE1508N
PF1508N
FEATURES

- * Cathode & Anode Common
- * 3 Phase Half Bridge Circuit
- * High Surge Capability
- * UL Recognized, File No. E187184

TYPICAL APPLICATIONS

- * Rectified For General Use

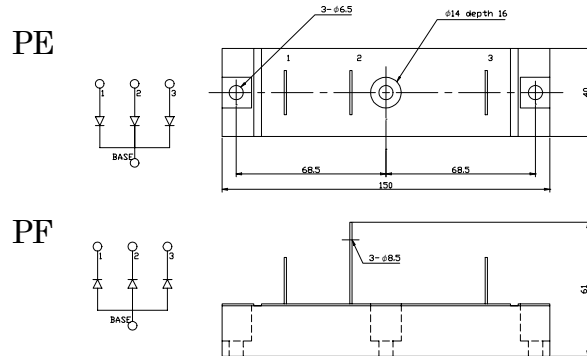
OUTLINE DRAWING

Maximum Ratings

Approx Net Weight:315g

Parameter	Symbol	Type / Grade	Unit
		PE1508 / PF1508	
Repetitive Peak Reverse Voltage *1	V_{RRM}	800	V
Non Repetitive Peak Reverse Voltage *1	V_{RSM}	960	

Parameter	Symbol	Conditions	Max Rated Value	Unit	
Average Rectified Output Current *1	$I_{O(AV)}$	50Hz Half Sine Wave condition $T_c=103^{\circ}C$	150	A	
		3 Phase $T_c=99^{\circ}C$	132	A	
Surge Forward Current *1	I_{FSM}	50 Hz Half Sine Wave,1Pulse Non-repetitive	3200	A	
I Squared t *1	I^2t	2msec to 10msec	51200	A^2s	
Operating JunctionTemperature Range	T_{jw}		-40 to +150	$^{\circ}C$	
Storage Temperature Range	T_{stg}		-40 to +125	$^{\circ}C$	
Mounting torque	Case mounting	Greased	M6 Screw	2.5 to 3.5	N.m
	Terminals	M8 Screw		9.0 to 10.0	

Electrical • Thermal Characteristics

Characteristics	Symbol	Test Conditions	Max.	Unit
Peak Reverse Current *1	I_{RM}	$V_{RM}= V_{RRM}, T_j= 150^{\circ}C$	20	mA
Peak Forward Voltage *1	V_{FM}	$I_{FM}= 450A, T_j=25^{\circ}C$	1.28	V
Thermal Resistance *1	$R_{th(j-c)}$	Junction to Case	0.25	$^{\circ}C/W$
	$R_{th(c-f)}$	Base Plate to Heat Sink with Joint Compound	0.1	

*1: Value Per 1Arm

PE/PF1508 OUTLINE DRAWING (Dimensions in mm)

PE

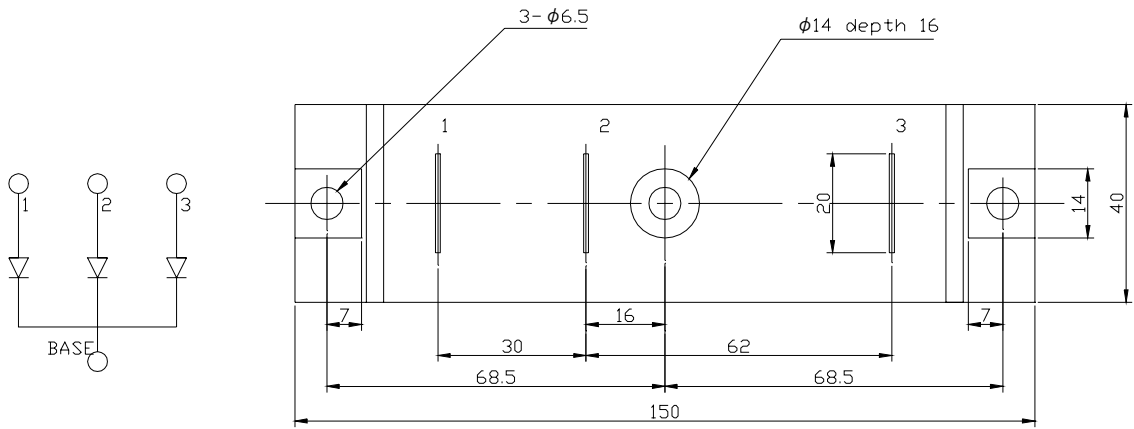

PF

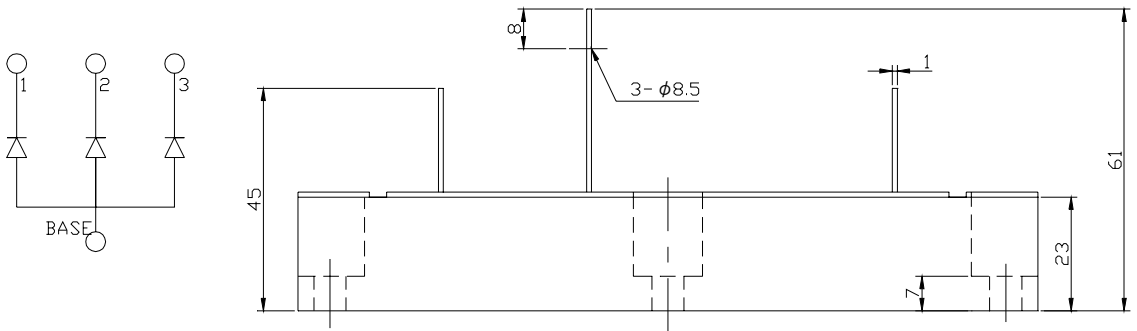

順電圧特性
FORWARD CURRENT VS. VOLTAGE

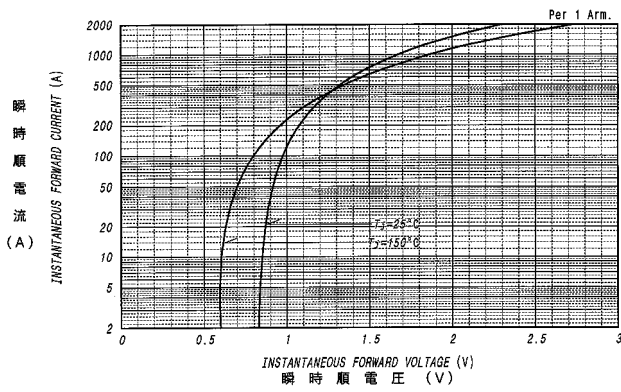

平均順電力損失特性
AVERAGE FORWARD POWER DISSIPATION

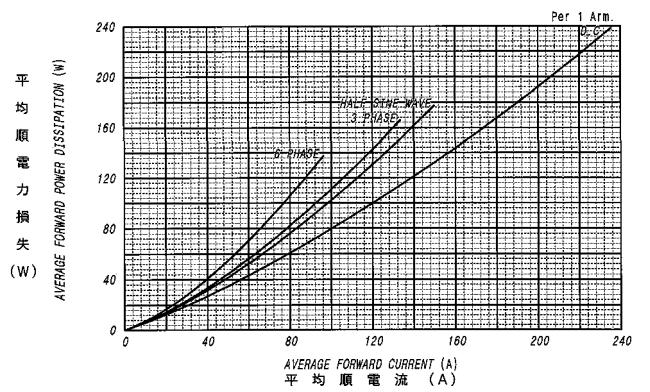

平均順電流 - ケース温度定格
AVERAGE FORWARD CURRENT VS. CASE TEMPERATURE

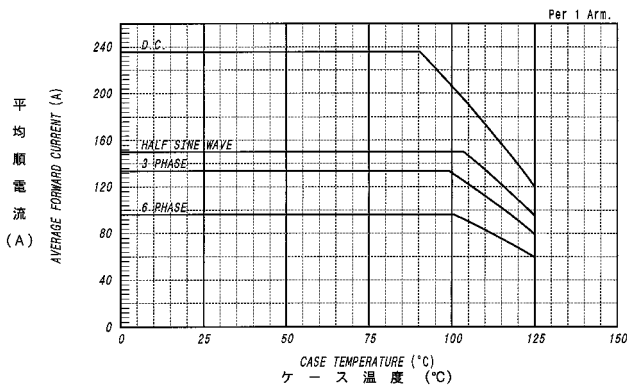

サージ順電流定格
SURGE CURRENT RATINGS

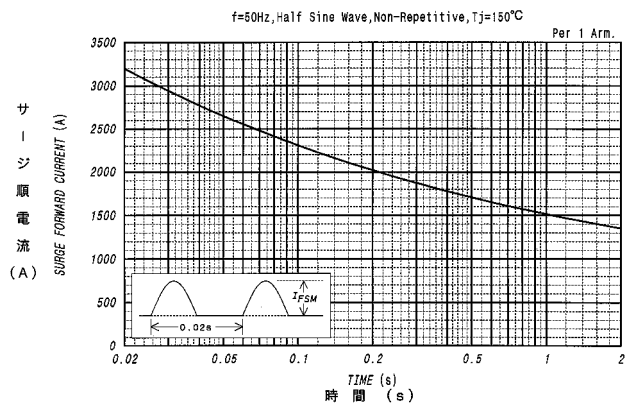

過渡熱抵抗特性
MAXIMUM TRANSIENT THERMAL IMPEDANCE
Junction to Case

