

PE42445

Document Category: Product Specification

High Isolation UltraCMOS® SP4T RF Switch, 10 MHz–8.5 GHz



Features

- Operating frequency: Up to 8.5 GHz
- High isolation: 62 dB @ 4 GHz
- Low insertion loss: 0.7 dB @ 4 GHz
- High linearity: 65 dBm IIP3 @ 3.8 GHz
- Fast switching time: 200 nsec
- -40 °C to +125 °C operating temperature
- Packaging – 20-lead 3×3 mm LGA

Applications

- DPD feedback loop and VSWR monitoring
- 5G massive MIMO active antenna systems
- Analog/hybrid beamforming RF front ends
- 4G/4.5G TD-LTE macro/micro cell/RRH
- Test and measurement

Figure 1 ■ PE42445 Functional Diagram

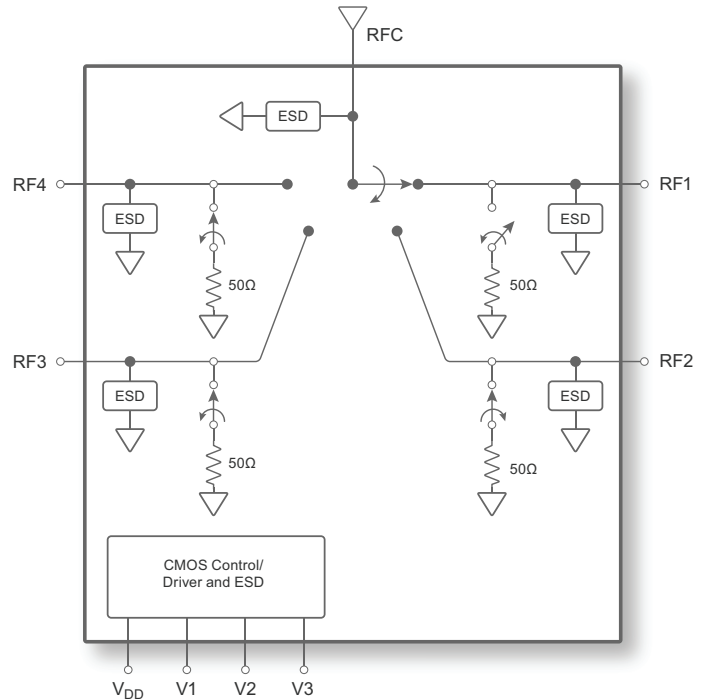

Product Description

The PE42445 is a HaRP™ technology-enhanced SP4T RF switch designed for use in 4G/5G wireless infrastructure and other high performance RF applications. It is comprised of four symmetric RF ports with very high isolation up to 8.5 GHz. The PE42445 is manufactured on pSemi's UltraCMOS® process, a patented variation of silicon-on-insulator (SOI) technology. pSemi's HaRP technology enhancements deliver high isolation, linearity and excellent harmonics performance.

Revision History

Table 1 ■ *Revision History*

Document Revision	Date	Change Description
DOC-108552-5	November 2023	Upper frequency range
DOC-108552-6	December 2023	Features section Table 2, Absolute Maximum Ratings Table 3, Recommended Operating Conditions Table 4, Electrical Specifications. Figure 3, Package Mechanical Drawing
DOC-108552-7	February 2024	Figures 2 through 17, Typical Performance Data Table 3, Recommended Operating Conditions Table 4, Electrical Specifications Table note in Tables 5 and 6 Figure 21, Tape and Reel Specification
DOC-108552-8	March 2024	Figure 21, Tape and Reel Specification

Absolute Maximum Ratings

Exceeding absolute maximum ratings listed in **Table 2** may cause permanent damage. Operation should be restricted to the limits in **Table 4**. Operation between operating range maximum and absolute maximum for extended periods may reduce reliability.

ESD Precautions

When handling this UltraCMOS device, observe the same precautions as with any other ESD-sensitive devices. Although this device contains circuitry to protect it from damage due to ESD, precautions should be taken to avoid exceeding the rating specified in **Table 2**.

Latch-up Immunity

Unlike conventional CMOS devices, UltraCMOS devices are immune to latch-up.

Table 2 ■ Absolute Maximum Ratings for PE42445

Description	Min	Typ	Max	Unit
Power supply voltage	2.3		5.5	V
Digital input voltage (V1, V2, V3)	-0.3		3.6	V
Storage temperature range	-60		150	°C
Maximum junction temperature range			150	°C
RF input RMS power, RFX to RFC, hot switching, LTE PAR 9 dB, Freq = 3.8 GHz @105 °C			29	dBm
RF input RMS power, RFX to RFC, hot switching, LTE PAR 9 dB, Freq = 3.8 GHz @125 °C			26	dBm
RF input RMS power terminated port, hot switching, LTE PAR 9 dB, Freq = 3.8 GHz @105 °C			29	dBm
RF input RMS power terminated port, hot switching, LTE PAR 9 dB, Freq = 3.8 GHz @125 °C			26	dBm
ESD voltage HBM1, all pins ⁽¹⁾			2000	V
ESD voltage CDM2, all pins ⁽²⁾			1000	V

Notes:

- 1) Human body model (MIL-STD 883 Method 3015).
- 2) Charged device model (JEDEC JESD22-C101).

Recommended Operating Conditions

Table 3 lists the recommended operating conditions for the PE42445. Devices should not be operated outside the operating conditions listed below.

Table 3 ■ Recommended Operating Conditions for PE42445

Parameter	Min	Typ	Max	Unit
V _{DD} supply voltage	2.3	3.3	5.5	V
Power supply current V _{DD} = 3.3V		93	250	μA
Control voltage high	1.07		3.6	V
Control voltage low	-0.3		0.68	V
Digital input current		2		μA
Operating temperature range	-40		125	°C
Frequency range	10		8500	MHz
RF input power, CW (P _{MAX,CW} +105°C)			34	dBm
RF input power, CW (P _{MAX,CW} +125°C)			32	dBm
RF input power into terminated ports, CW (P _{MAX,CW} +105°C)			25	dBm
RF input power into terminated ports, CW (P _{MAX,CW} +125°C)			21	dBm

Electrical Specifications

Table 4 provides the PE42445 key electrical specifications @ +25 °C (ZS = ZL = 50Ω), unless otherwise specified.

Table 4 ■ PE42445 Electrical Specifications

Parameter	Condition	Min	Typ	Max	Unit
Frequency Range		10		8500	MHz
Insertion Loss, RFX to RFC	10 to 900 MHz		0.57	0.62	dB
	900 to 2100 MHz		0.62	0.69	dB
	2100 to 2700 MHz		0.64	0.73	dB
	2700 to 4000 MHz		0.68	0.81	dB
	4000 to 6000 MHz		0.76	0.98	dB
	6000 to 8000 MHz		0.91	1.27	dB
	8000 to 8500 MHz		1.00	1.50	dB
Isolation, RFX to RFC	10 to 900 MHz		72		dB
	900 to 2100 MHz		69		dB
	2100 to 2700 MHz		67		dB
	2700 to 4000 MHz		65		dB
	4000 to 6000 MHz		56		dB
	6000 to 8000 MHz		48		dB
	8000 to 8500 MHz		46		dB
Isolation, RFX to RFX	10 to 900 MHz		59		dB
	900 to 2100 MHz		52		dB
	2100 to 2700 MHz		50		dB
	2700 to 4000 MHz		47		dB
	4000 to 6000 MHz		43		dB
	6000 to 8000 MHz		39		dB
	8000 to 8500 MHz		37		dB
Return Loss, RF1/2/3/4 On State	10 to 900 MHz		27		dB
	900 to 2100 MHz		24		dB
	2100 to 2700 MHz		24		dB
	2700 to 4000 MHz		23		dB
	4000 to 6000 MHz		20		dB
	6000 to 8000 MHz		15		dB
	8000 to 8500 MHz		13		dB

Table 4 ■ PE42445 Electrical Specifications (Cont.)

Parameter	Condition	Min	Typ	Max	Unit
Return Loss, RF1/2/3/4 Off State	10 to 900 MHz		33		dB
	900 to 2100 MHz		25		dB
	2100 to 2700 MHz		23		dB
	2700 to 4000 MHz		22		dB
	4000 to 6000 MHz		20		dB
	6000 to 8000 MHz		17		dB
	8000 to 8500 MHz		17		dB
Input 0.1dB Compression	3800 MHz		37		dBm
Input IP3, RFX to RFC	3800 MHz		65.5		dBm
Input IP2, RFX to RFC	3800 MHz		110		dBm
Switching time	50% CTRL to 90% or 10% RF		200		ns

SP4T Control Logic

Table 5 provides the control logic truth table for the PE42445.

Table 5 ▪ Truth Table for PE42445

ON Port	V3	V2	V1
RF4 on ^(*)	0	0	0
RF1 on	0	0	1
RF2 on	0	1	0
RF3 on	0	1	1
RF4 on	1	0	0
All off	1	0	1
All off	1	1	0
All off	1	1	1

Note: * Pin 17 (V3) must be grounded for 2-pin control. 2-pin control can be used if All off mode is not required.

Truth Table of 2-pin Control Only

Table 6 provides the truth table for 2-pin control of the PE42445.

Table 6 ▪ 2-pin Control Truth Table for PE42445

Mode	V2	V1
RF4 on ^(*)	0	0
RF1 on	0	1
RF2 on	1	0
RF3 on	1	1

Note: * Pin 17 (V3) must be grounded for 2-pin control. 2-pin control can be used if All off mode is not required.

Typical Performance Data

[Figure 2–Figure 17 show the typical performance data at +25 °C TCASE, VDD = 5V (ZS = ZL = 50Ω), unless otherwise specified.

Figure 2 ■ Insertion Loss vs. Switch Path

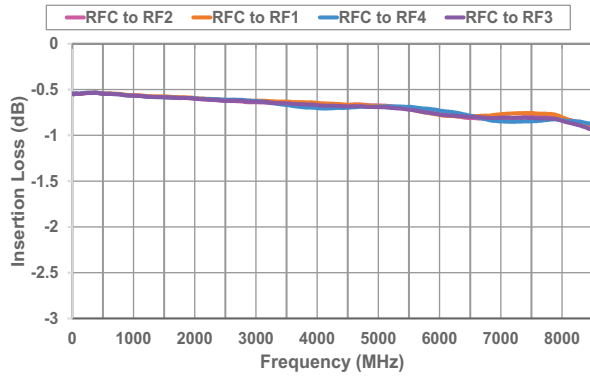

Figure 3 ■ Insertion Loss vs. Temperature

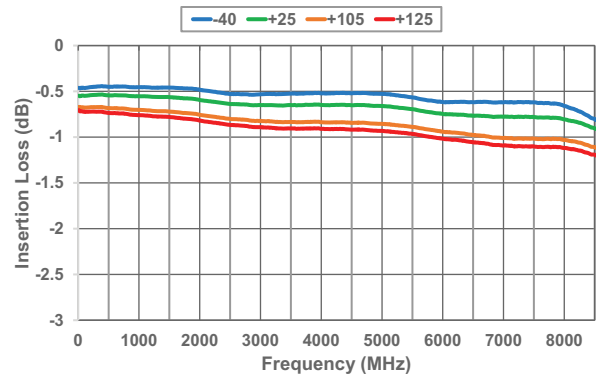

Figure 4 ■ Insertion Loss vs. Voltage

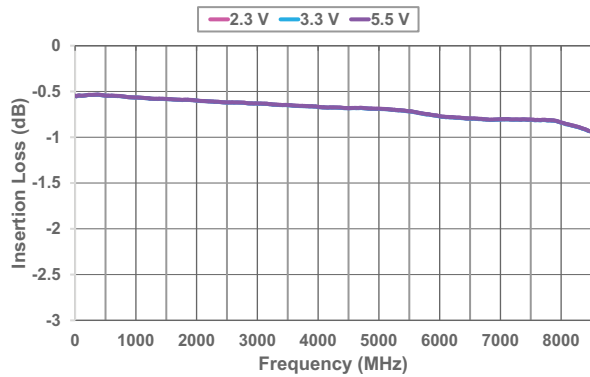

Figure 5 ■ Isolation (RFC–RFX) vs. Switch Path

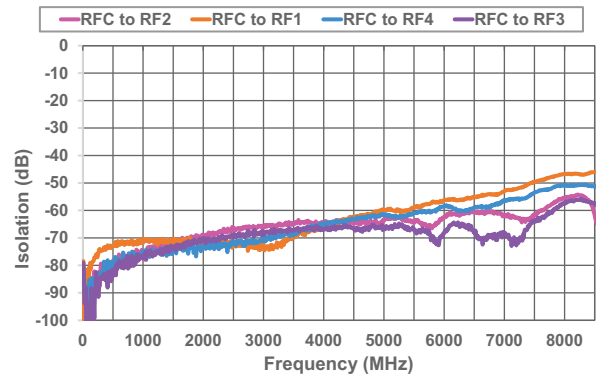

Figure 6 ■ Isolation (RFC–RFX) vs. Temperature

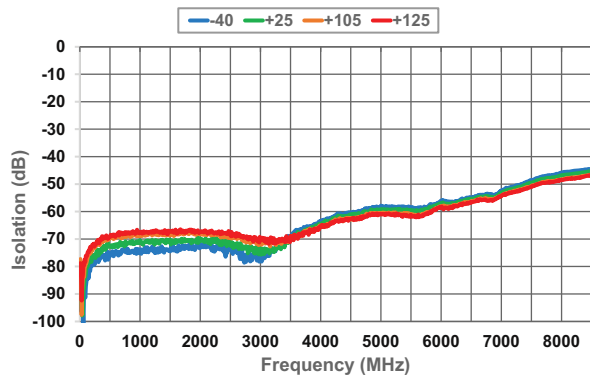

Figure 7 ■ Isolation (RFC–RFX) vs. Voltage

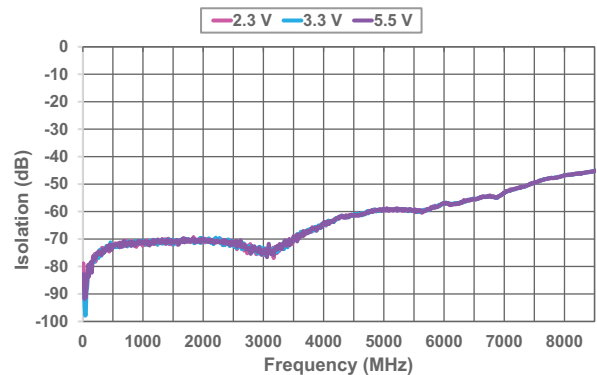

Figure 8 ■ Isolation (RFX-RFX) vs. Temperature

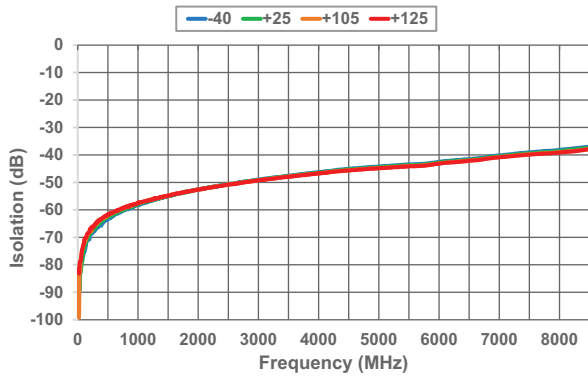

Figure 9 ■ Isolation (RFX-RFX) vs. Voltage

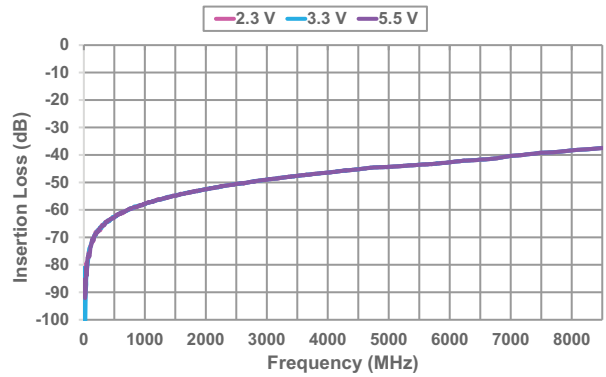

Figure 10 ■ RFX Return Loss vs. Switch Path

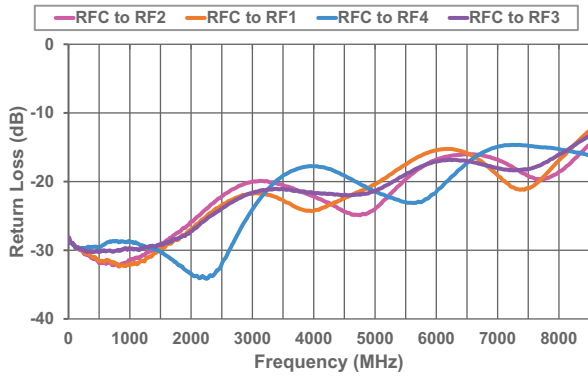

Figure 11 ■ RFX Return Loss vs. Temperature

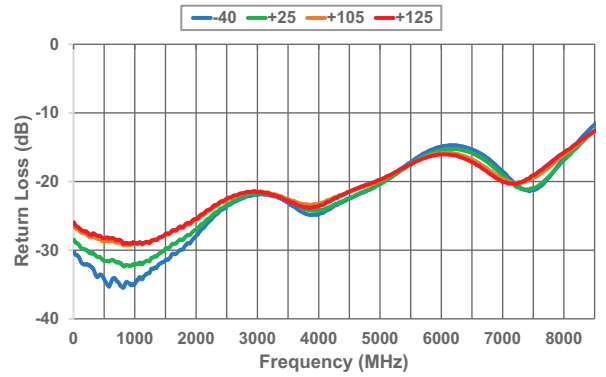

Figure 12 ■ RFX Return Loss vs. Voltage

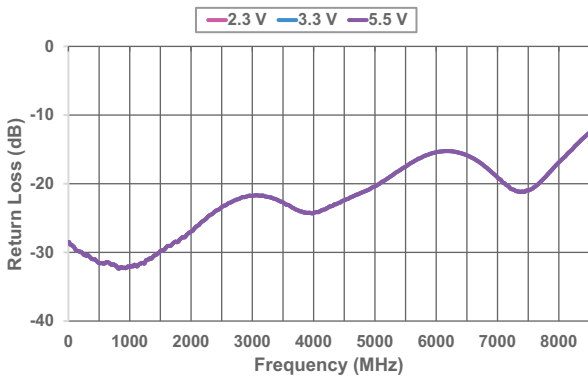

Figure 13 ■ RFC Return Loss vs. Switch Path

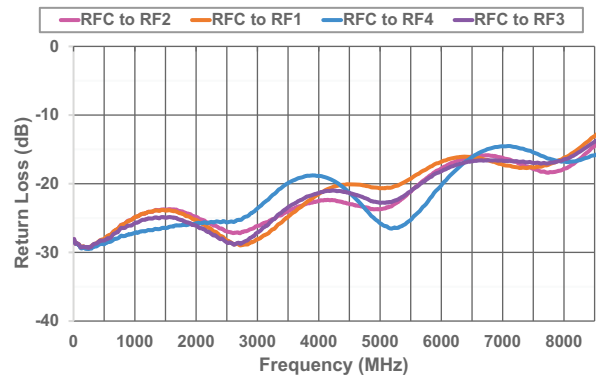

Figure 14 ■ RFC Return Loss vs. Temperature

Figure 15 ■ RFC Return Loss vs. Voltage

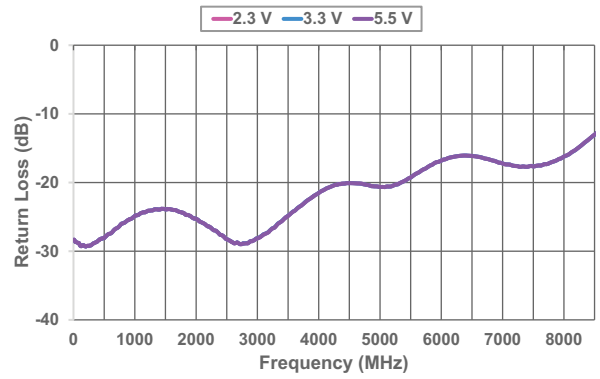
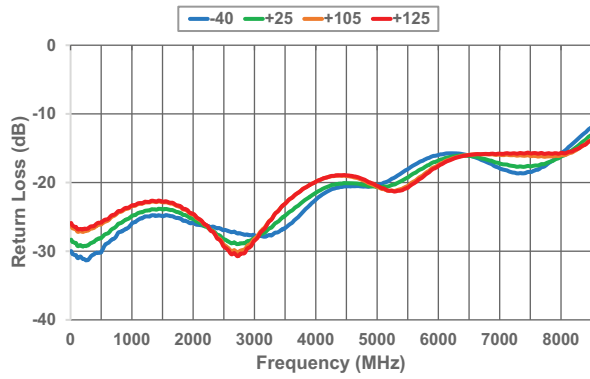
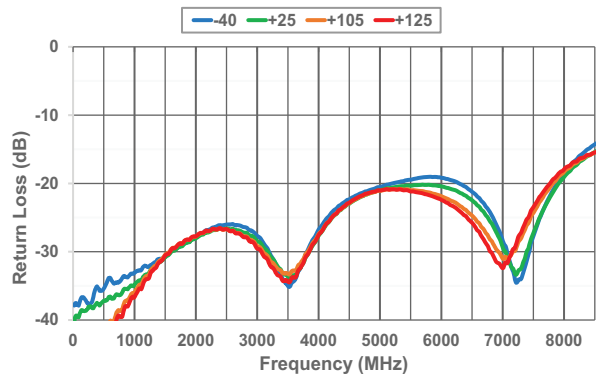
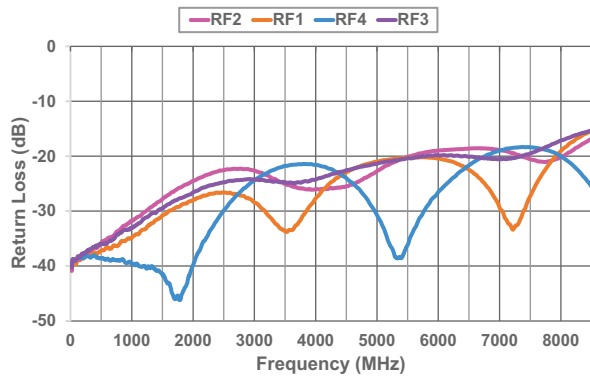

Figure 16 ■ RFX Terminated, Return Loss

Figure 17 ■ RFX Terminated, Return Loss vs. Temperature



Pin Information

This section provides pinout information for the PE42445. **Figure 18** shows the pin map of this device for the available package. **Table 7** provides a description for each pin.

Figure 18 ▪ Pin Configuration (Top View)

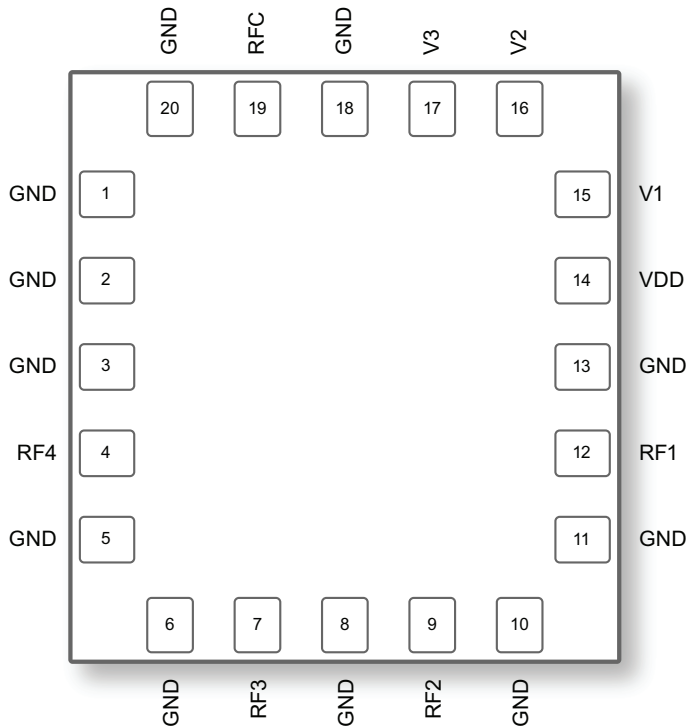

Table 7 ▪ Pin Descriptions for PE42445

Pin No.	Pin Name	Description
1,2,3,5,6,8,10,11,13,18,20	GND	Ground
4	RF4	RF port 4
7	RF3	RF port 3
9	RF2	RF port 2
12	RF1	RF port 1
14	VDD	Supply voltage
15	V1	Digital control logic input 1
16	V2	Digital control logic input 2
17	V3	Digital control logic input 3
19	RFC	RF common
21	GND	Backside GND pad

Packaging Information

This section provides packaging data including the moisture sensitivity level, package drawing, package marking and tape-and-reel information.

Moisture Sensitivity Level

The moisture sensitivity level rating for the PE42445 in the 20-lead 3×3 mm LGA package is MSL 3.

Package Drawing

Figure 19 ■ Package Mechanical Drawing for 20-lead 3×3 mm LGA

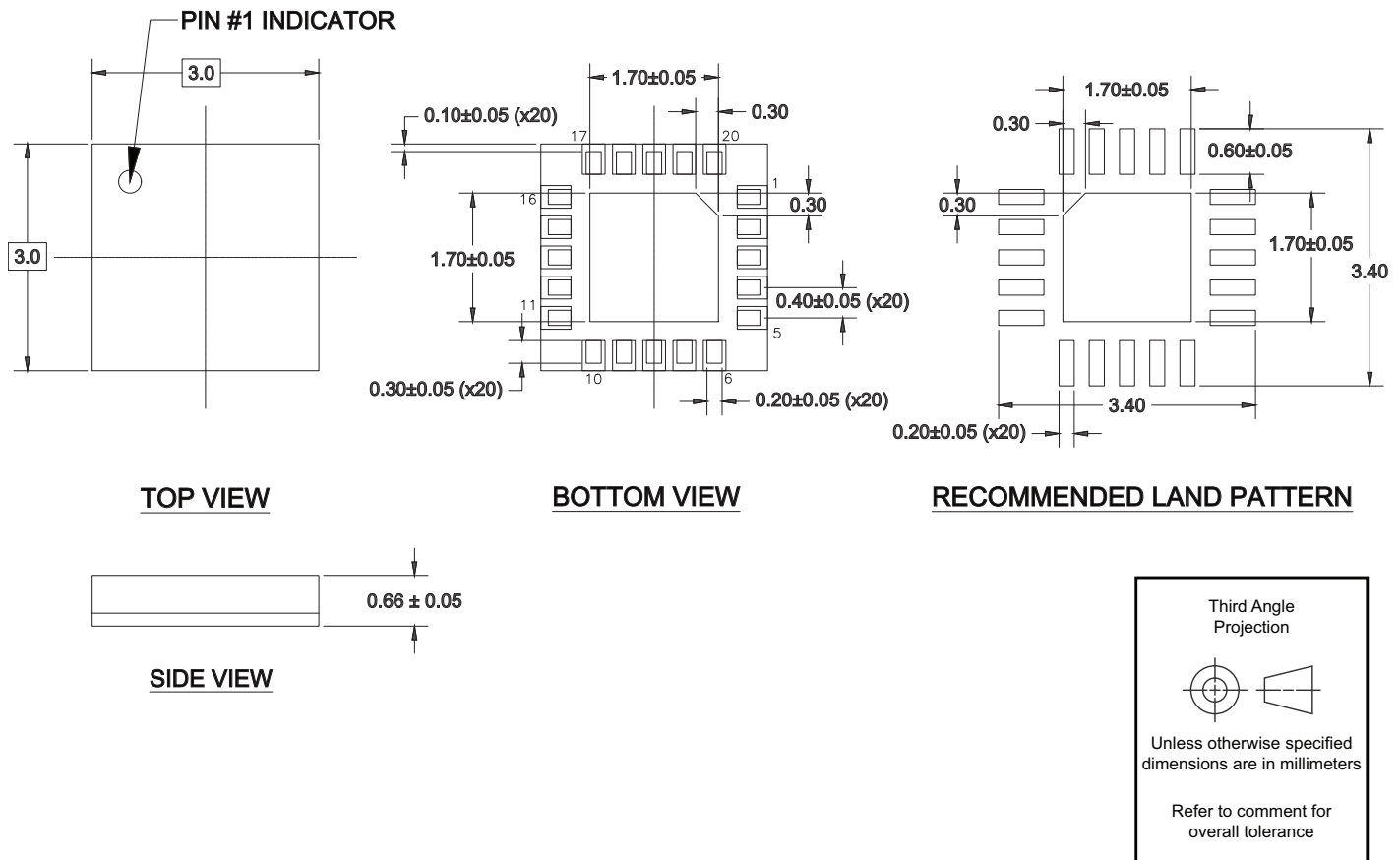

Top-Marking Specification

Figure 20 ■ Package Marking Specifications for PE42445

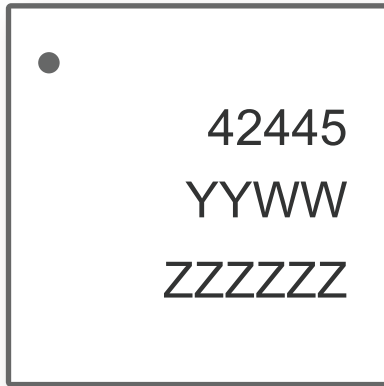

- = Pin 1 indicator
- 42445 = Product part number
- YY = Last two digits of assembly year (2022 = 22)
- WW = Work week of assembly lot start date (01, ..., 52)
- ZZZZZZ = Assembly lot code (max six characters)

DOC-108599-2

Tape and Reel Specification

Figure 21 ■ Tape and Reel Specifications for 20-lead 3×3 mm LGA

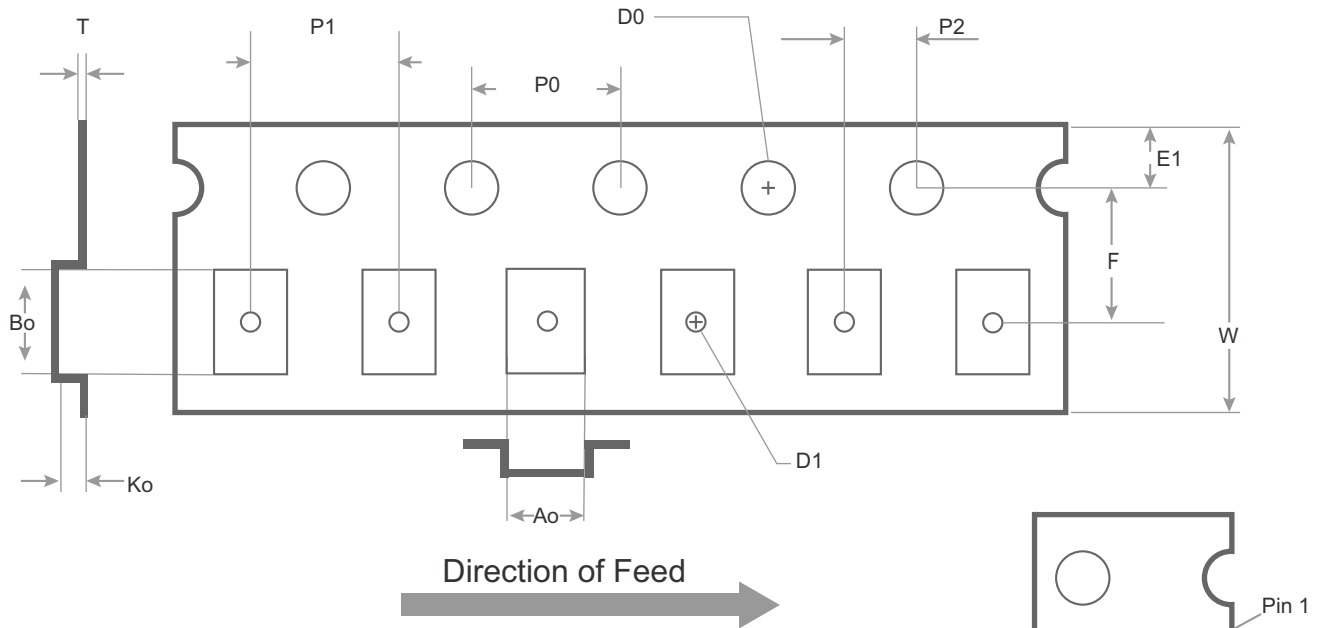

Notes:

Not drawn to scale.
Dimensions are in millimeters.
Maximum cavity angle 5 degrees.
Bumped die are oriented active side down.

Carrier Tape Dimension Table					
Pocket	Nominal	Tolerance	Pocket	Nominal	Tolerance
Ao	3.30	+/- 0.1	D1	1.5	Min.
Bo	3.30	+/- 0.1	D0	1.55	+/- 0.05
Ko	1.10	+/- 0.1	E1	1.75	+/- 0.1
P1	8.00	+/- 0.1	P0	4.0	+/- 0.1
W	12.00	+/- 0.3	P2	2.0	+/- 0.05
F	5.50	+/- 0.05	T	0.3	+/- 0.05

Device Orientation in Tape

Ordering Information

Table 8 lists the available ordering codes for the PE42445 as well as available shipping methods.

Table 8 ■ Order Codes for PE42445

Order Codes	Description	Packaging	Shipping Method
PE42445A-Z	PE42445 SP4T RF switch	Green 20-lead 3×3 mm LGA	3000 units/T&R
EK42445-01	PE42445 Evaluation kit	Evaluation kit	1/box

Document Categories

Advance Information

The product is in a formative or design stage. The datasheet contains design target specifications for product development. Specifications and features may change in any manner without notice.

Preliminary Specification

The datasheet contains preliminary data. Additional data may be added at a later date. pSemi reserves the right to change specifications at any time without notice in order to supply the best possible product.

Product Specification

The datasheet contains final data. In the event pSemi decides to change the specifications, pSemi will notify customers of the intended changes by issuing a CNF (Customer Notification Form).

Product Brief

This document contains a shortened version of the datasheet. For the full datasheet, contact sales@psemi.com.

Sales Contact

For additional information, contact Sales at sales@psemi.com.

Disclaimers

The information in this document is believed to be reliable. However, pSemi assumes no liability for the use of this information. Use shall be entirely at the user's own risk. No patent rights or licenses to any circuits described in this document are implied or granted to any third party. pSemi's products are not designed or intended for use in devices or systems intended for surgical implant, or in other applications intended to support or sustain life, or in any application in which the failure of the pSemi product could create a situation in which personal injury or death might occur. pSemi assumes no liability for damages, including consequential or incidental damages, arising out of the use of its products in such applications.

Patent Statement

pSemi products are protected under one or more of the following U.S. patents: patents.psemi.com

Copyright and Trademark

©2022–2024, pSemi Corporation. All rights reserved. The Peregrine Semiconductor name, Peregrine Semiconductor logo and UltraCMOS are registered trademarks and the pSemi name, pSemi logo, HaRP and DuNE are trademarks of pSemi Corporation in the U.S. and other countries.