

COMMON MODE CHOKE CATALOG

Suited for LAN and Telecom Applications



TABLE of CONTENTS

Common Mode Chokes for Datacom Applications





Surface Mount Common Mode Chokes2-6

Through Hole Common Mode Chokes7-12

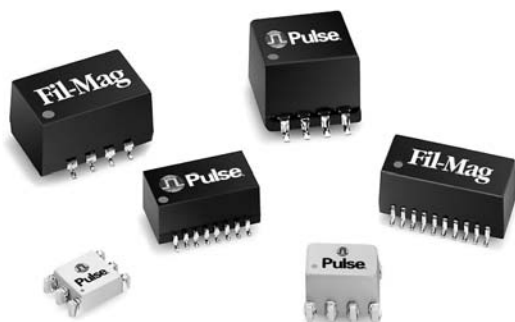
SURFACE MOUNT COMMON MODE CHOKES

Suited for LAN and Telecom Applications



-  Reduces radiated EMI emissions
-  Filters common mode noise for EMI reduction
-  Common mode attenuation from 100 kHz to 1 GHz
-  Tape & Reel packaging available for surface mount parts*

Electrical Specifications @ 25°C

Part Number	No. of Lines	Primary Inductance OCL (μH MIN)	Common Mode Attenuation (dB TYP)									DCR (Ω MAX)	Page Number of Mech. & Schem.
			100 KHz	1 MHz	10 MHz	30 MHz	50 MHz	100 MHz	300 MHz	500 MHz	1 GHz		
PE-68624	2	47	11	27	40	44	42	36	26	17	—	0.40	2
PE-65855	2	4700	41	43	49	39	34	26	20	20	12	1.0	4
B2013	2	6300	46	47	43	32	25	29	21	14	16	1.0	3
B4003	2	4700	42	41	48	38	33	21	22	23	17	1.0	6
R0003	3	20	6	14	27	30	30	30	30	28	25	0.40	2
23Z87SM	3	69	9	24	31	30	29	27	21	16	—	0.20	4
PE-65857	4	22.5	7	20	30	37	38	34	24	13	—	0.22	4
PE-68627	4	24	8	21	32	36	37	36	30	20	—	0.25	4
T8003	4	33	9	13	32	32	30	27	16	17	13	0.20	6
23Z4000SMD	4	36	7	23	35	38	38	36	29	24	—	0.50	5
PE-65738	4	37	8	21	28	28	28	27	25	22	—	0.30	3
PE-65854	4	47	3	19	32	36	35	29	12	6	—	0.40	3
23Z104SM	4	68	8	22	28	28	27	25	20	15	—	0.20	5
PE-67540	4	100	14	33	44	48	49	44	34	29	20	0.60	4
PE-65853	4	4700	40	51	38	30	25	20	14	13	—	1.20	3
PE-68602	6	21	6	19	28	34	35	36	34	29	1	0.35	3
23Z106SM	6	68	8	22	29	30	30	29	24	19	—	0.20	5
PE-69011	8	36	8	24	36	39	35	29	18	11	—	0.35	3
23Z105SM	8	68	8	24	30	29	27	24	16	11	—	0.20	5
23Z109SM	10	7.5	4	9	20	25	26	24	16	11	—	0.20	5
T8008	16	47	7	27	40	44	42	36	26	—	—	0.40	6

* When ordering Tape & Reel packaging, add a "T" at the end of the part number (i.e. PE-65738T or 23Z106SMT).

NOTE: Additional common mode chokes are available. Please contact Applications Engineering.

Mechanicals

Schematics

PE-68624, R0003

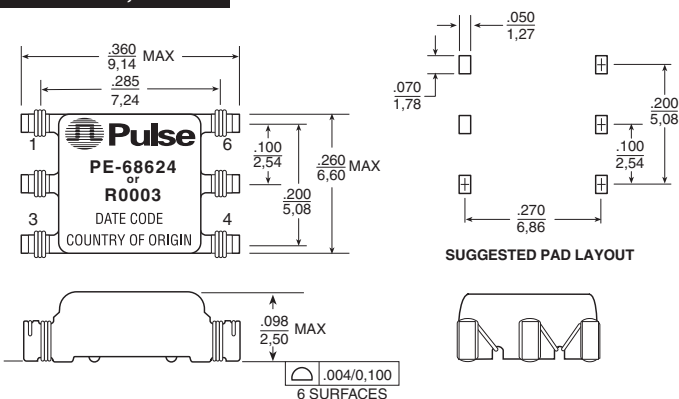

R0003

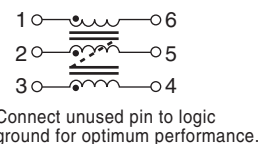

PE-68624



SURFACE MOUNT COMMON MODE CHOKES

Suited for LAN and Telecom Applications



Mechanicals

Schematics

PE-65738, PE-68602, PE-69011

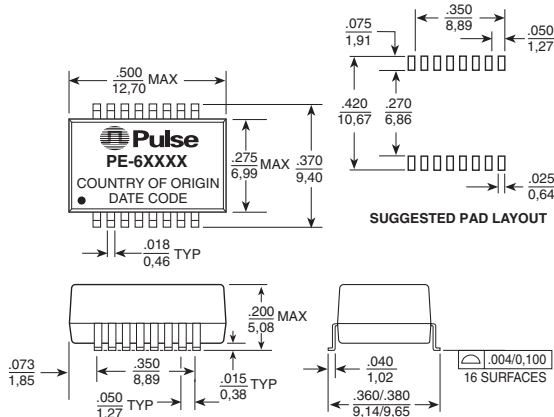

Dimensions: $\frac{\text{Inches}}{\text{mm}}$
Unless otherwise specified,
all tolerances are $\pm \frac{.010}{0.25}$

Weight0.83 grams
Tape & Reel900/reel
Tube40/tube

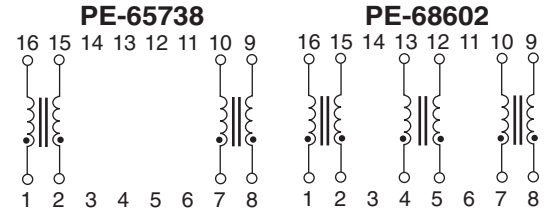

PE-69011

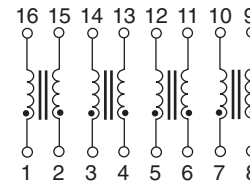

PE-65853

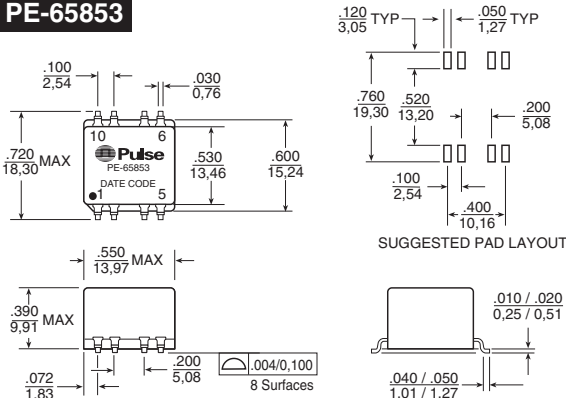

Dimensions: $\frac{\text{Inches}}{\text{mm}}$
Unless otherwise specified,
all tolerances are $\pm \frac{.010}{0.25}$

Weight4.0 grams
Tape & Reel150/reel
Tube35/tube

PE-65853

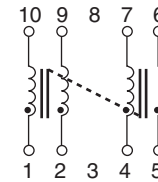

B2013

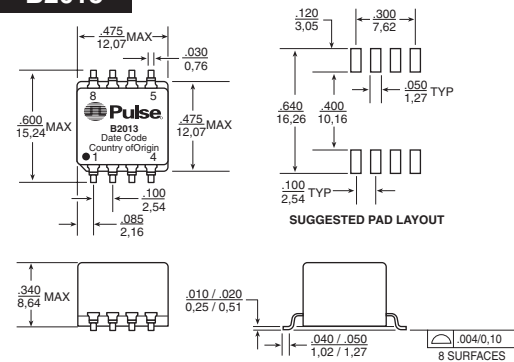

Dimensions: $\frac{\text{Inches}}{\text{mm}}$
Unless otherwise specified,
all tolerances are $\pm \frac{.010}{0.25}$

Weight9.5 grams
Tray30/tray

B2013



PE-65854

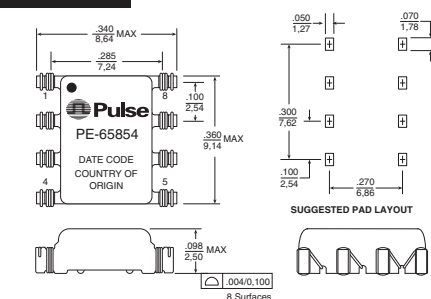

Dimensions: $\frac{\text{Inches}}{\text{mm}}$
Unless otherwise specified,
all tolerances are $\pm \frac{.010}{0.25}$

Weight0.3 grams
Tape & Reel1500/reel
Tube60/tube

PE-65854

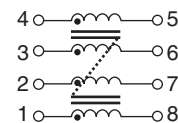

SURFACE MOUNT COMMON MODE CHOKES

Suited for LAN and Telecom Applications



Mechanicals

Schematics

PE-65855

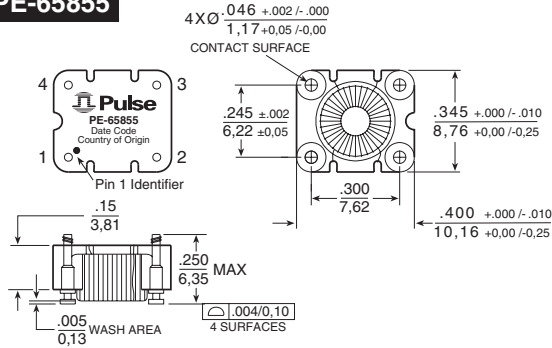

Dimensions: Inches
mm
Unless otherwise specified,
all tolerances are $\pm .010$
 $0,25$

Weight 0.69 grams
Tape & Reel800/reel
Tube40 /tube

PE-65855



PE-65857, PE-67540

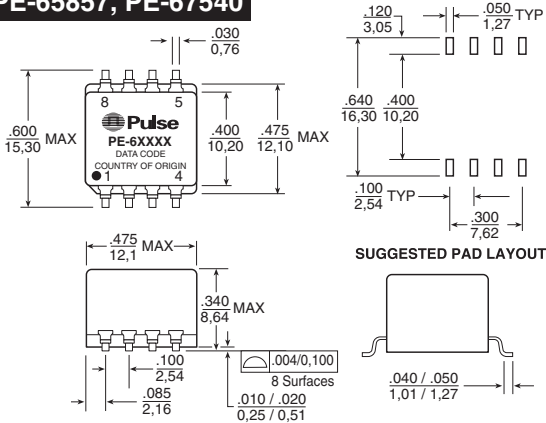

Dimensions: Inches
mm
Unless otherwise specified,
all tolerances are $\pm .010$
 $0,25$

Weight 2.0 grams
Tape & Reel250/reel
Tube40/tube

PE-65857

PE-67540

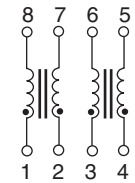
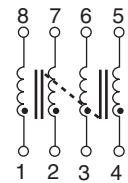

PE-68627

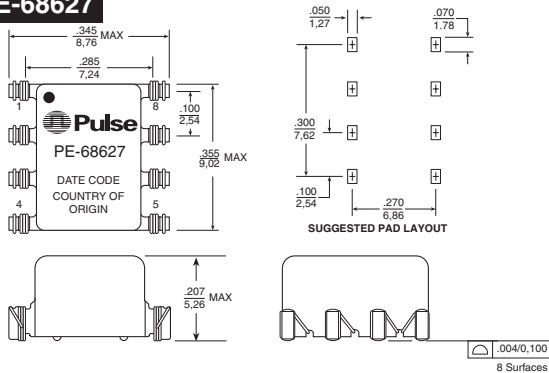

Dimensions: Inches
mm
Unless otherwise specified,
all tolerances are $\pm .010$
 $0,25$

Weight 0.3 grams
Tape & Reel1500/reel
Tube55/tube

PE-68627

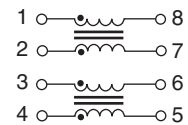

23Z87SM

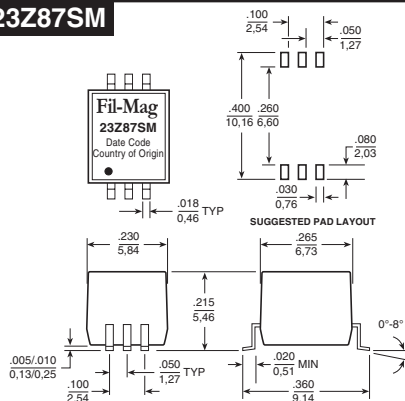

Dimensions: Inches
mm
Unless otherwise specified,
all tolerances are $\pm .005$
 $0,13$

Weight 0.5 grams
Tape & Reel750/reel
Tube 100/tube

23Z87SM



SURFACE MOUNT COMMON MODE CHOKES

Suited for LAN and Telecom Applications



Mechanicals

Schematics

23Z104SM

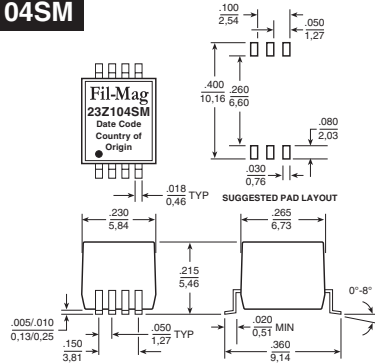

Dimensions: Inches
mm
Unless otherwise specified,
all tolerances are $\pm .005$
0,13

Weight 0.5 grams
Tape & Reel750/reel
Tube 100/tube

23Z104SM

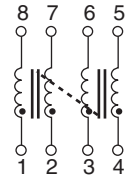

23Z105SM, 23Z106SM

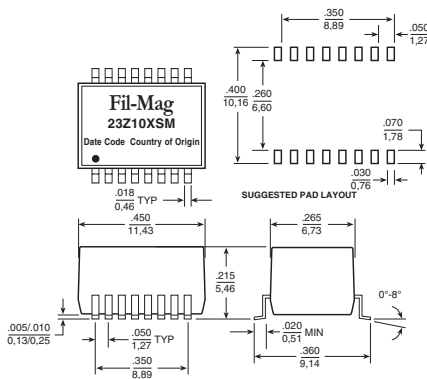

Dimensions: Inches
mm
Unless otherwise specified,
all tolerances are $\pm .005$
0,13

23Z105SM **23Z106SM**
Weight 0.8 grams 1.0 grams
Tape & Reel750/reel750/reel
Tube50/tube50/tube

23Z105SM

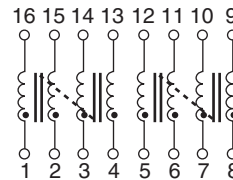

23Z106SM

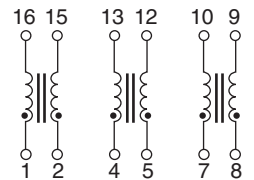

23Z109SM

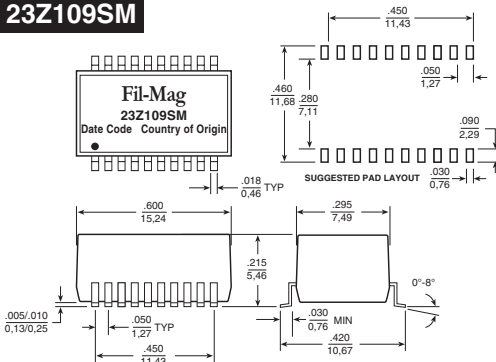

Dimensions: Inches
mm
Unless otherwise specified,
all tolerances are $\pm .005$
0,13

Weight 1.3 grams
Tape & Reel500/reel
Tube38/tube

23Z109SM

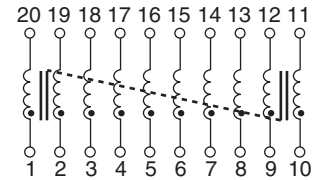

23Z4000SMD

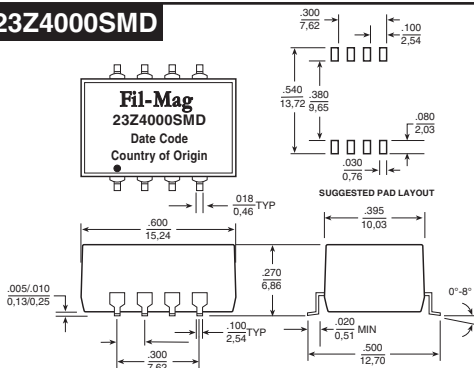

Dimensions: Inches
mm
Unless otherwise specified,
all tolerances are $\pm .005$
0,13

Weight 2.1 grams
Tape & Reel350/reel
Tube38/tube

23Z4000SMD

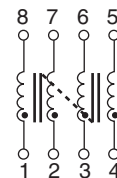

SURFACE MOUNT COMMON MODE CHOKES

Suited for LAN and Telecom Applications



Mechanicals

Schematics

T8003

T8003

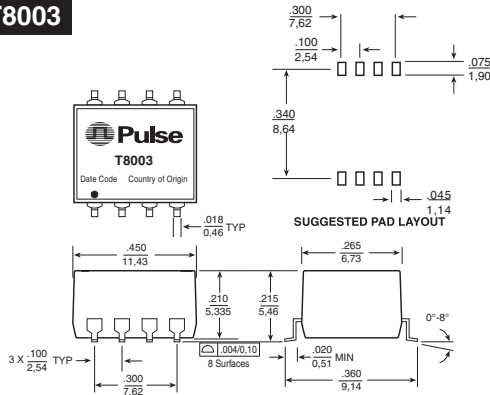

Dimensions: $\frac{\text{Inches}}{\text{mm}}$
Unless otherwise specified,
all tolerances are $\pm \frac{.005}{0,13}$

Weight 0.84 grams
Tape & Reel750/reel
Tube 100/tube

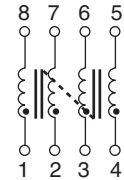

T8055

T8055

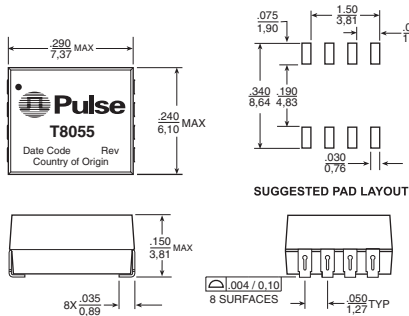

Dimensions: $\frac{\text{Inches}}{\text{mm}}$
Unless otherwise specified,
all tolerances are $\pm \frac{.010}{0,25}$

Weight 0.2 grams
Tape & Reel1750/reel
Tube80/tube

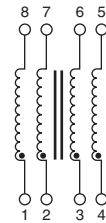

B4003

B4003

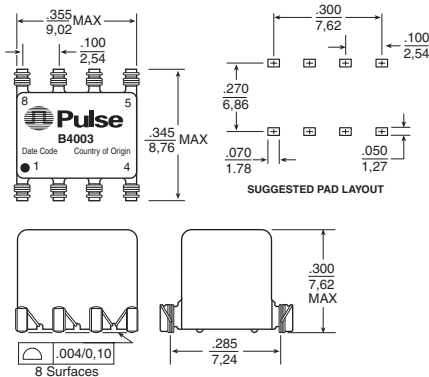

Dimensions: $\frac{\text{Inches}}{\text{mm}}$
Unless otherwise specified,
all tolerances are $\pm \frac{.010}{0,25}$

Weight 1.0 grams
Tape & Reel425/reel
Tube50/tube

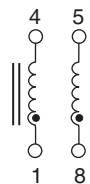

T8008

T8008

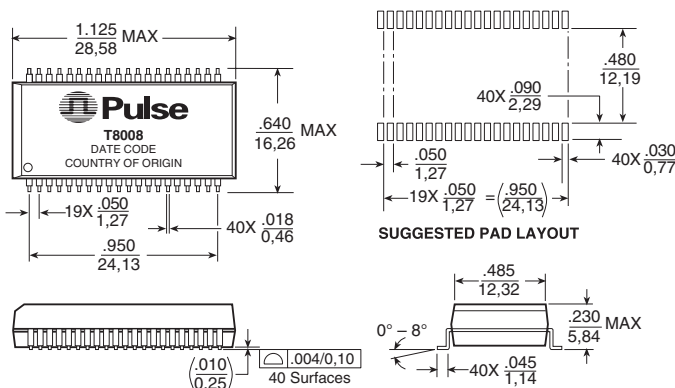

Dimensions: $\frac{\text{Inches}}{\text{mm}}$
Unless otherwise specified,
all tolerances are $\pm \frac{.010}{0,25}$

Weight 4.0 grams
Tape & Reel250/reel
Tube15/tube

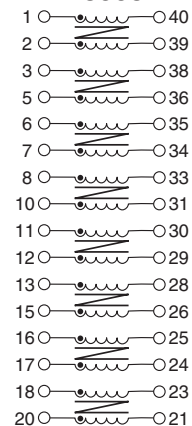



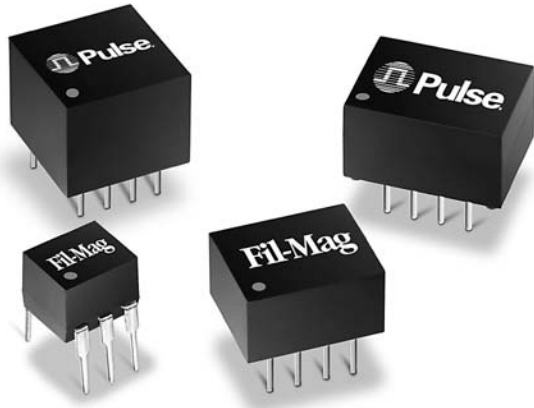

NOTE: The common mode test circuit for surface mount is the same as for through hole and is on the back page.

THROUGH HOLE COMMON MODE CHOKES

Suited for LAN and Telecom Applications



-  Reduces radiated EMI emissions
-  Filters common mode noise for EMI reduction
-  Common mode attenuation from 100 KHz to 1 GHz
-  Tube packaging available for through hole parts

Electrical Specifications @ 25°C

Part Number	No. of Lines	Primary Inductance OCL (μH MIN)	Common Mode Attenuation (dB TYP)									DCR (Ω MAX)	Page Number of Mech. & Schem.
			100 KHz	1 MHz	10 MHz	30 MHz	50 MHz	100 MHz	300 MHz	500 MHz	1 GHz		
PE-65944	2	24	1	14	28	32	33	28	13	5	—	0.30	9
23Z107	2	68	8	25	33	32	30	27	18	12	—	0.20	10
PE-67531	2	140	14	34	45	49	50	47	38	32	25	0.60	9
B2005	2	9000	47	47	41	30	22	33	21	15	15	1.0	10
PE-65554	4	24	—	21	32	38	39	34	24	13	—	0.30	8
42Z4000	4	36	8	24	37	40	40	38	30	24	—	0.20	10
PE-67501	4	50	14	34	45	49	50	47	20	15	10	0.30	9
PE-68002	4	68	7	24	37	41	42	40	31	27	—	0.35	9
23Z104	4	85	8	23	29	29	28	25	17	11	—	0.20	10
PE-67539	4	140	14	33	44	48	48	43	33	28	19	0.60	9
PE-65542	4	1000	28	41	42	32	22	—	—	—	—	0.70	8
PT5039	4	3600	42	43	42	32	27	17	15	9	13	0.50	8
J0010D11	4	—	9	13	32	35	35	29	13	24	19	0.50	11
PE-65950	4	4700±30%	40	51	37	28	23	20	—	—	—	1.00	8
PE-65541	4	6000	44	54	33	32	29	—	—	—	—	1.40	8
PE-68613	4	3290	40	51	37	28	23	20	—	—	—	1.00	11
PE-64683	6	25	6	18	32	38	37	32	21	17	—	0.35	8

THROUGH HOLE COMMON MODE CHOKES

Suited for LAN and Telecom Applications



Mechanicals

Schematics

PE-64683

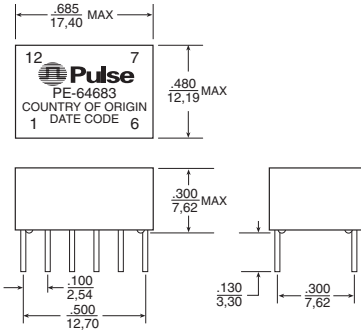

PE-64683

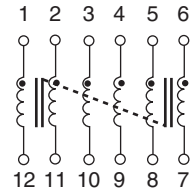

Dimensions: $\frac{\text{Inches}}{\text{mm}}$
Unless otherwise specified,
all tolerances are $\pm \frac{.010}{0,25}$

Weight0.27 grams
Tube30/tube

PE-65541, PE-65542, PE-65950

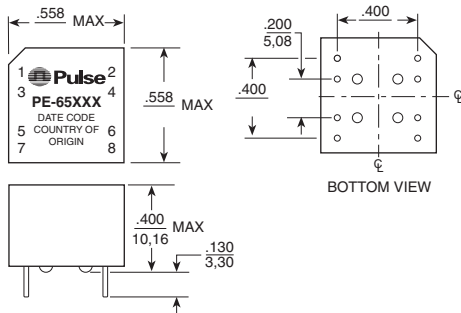

PE-65541 PE-65542 PE-65950

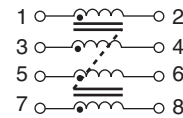

Dimensions: $\frac{\text{Inches}}{\text{mm}}$
Unless otherwise specified,
all tolerances are $\pm \frac{.010}{0,25}$

Weight0.38 grams
Tube35/tube

PE-65554

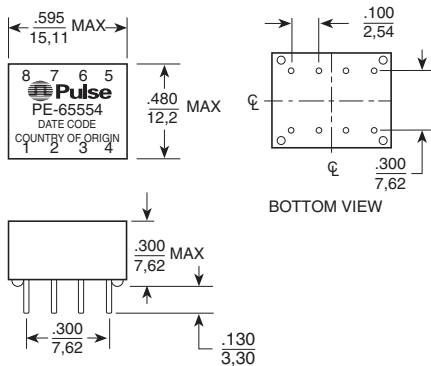

PE-65554

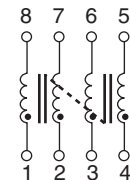

Dimensions: $\frac{\text{Inches}}{\text{mm}}$
Unless otherwise specified,
all tolerances are $\pm \frac{.010}{0,25}$

Weight2.5 grams
Tube35/tube

PT5039

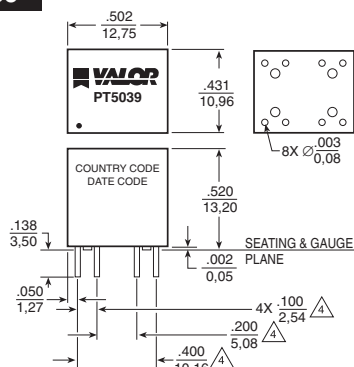

PT5039

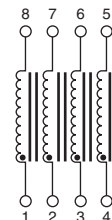

Dimensions: $\frac{\text{Inches}}{\text{mm}}$
Unless otherwise specified,
all tolerances are $\pm \frac{.010}{0,25}$

Weight2.5 grams
Tube35/tube

THROUGH HOLE COMMON MODE CHOKES

Suited for LAN and Telecom Applications



Pulse
A TECHNITROL COMPANY

Mechanicals

Schematics

PE-65944

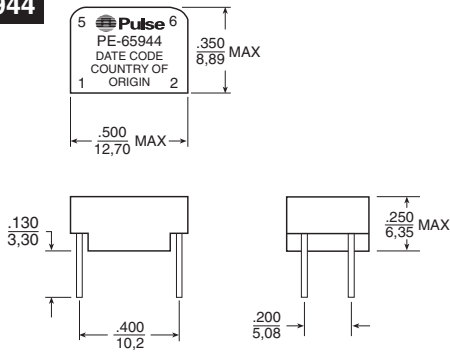

Dimensions: $\frac{\text{Inches}}{\text{mm}}$
Unless otherwise specified,
all tolerances are $\pm \frac{.010}{0,25}$

PE-65944



Weight1.07 grams
Tube30/tube

PE-67501, PE-67539

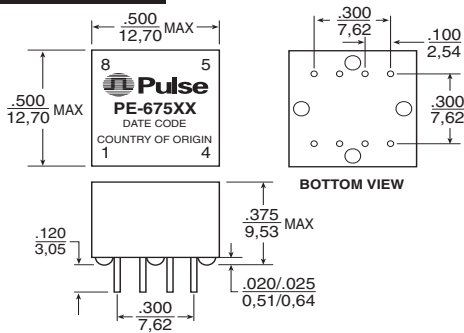

Dimensions: $\frac{\text{Inches}}{\text{mm}}$
Unless otherwise specified,
all tolerances are $\pm \frac{.010}{0,25}$

PE-67501 PE-67539

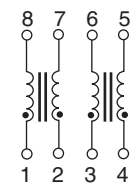

Weight2.4 grams
Tube40/tube

PE-67531

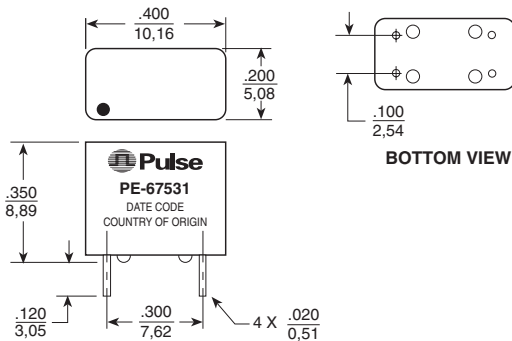

Dimensions: $\frac{\text{Inches}}{\text{mm}}$
Unless otherwise specified,
all tolerances are $\pm \frac{.010}{0,25}$

PE-67531



Weight0.76 grams
Tube40/tube

PE-68002

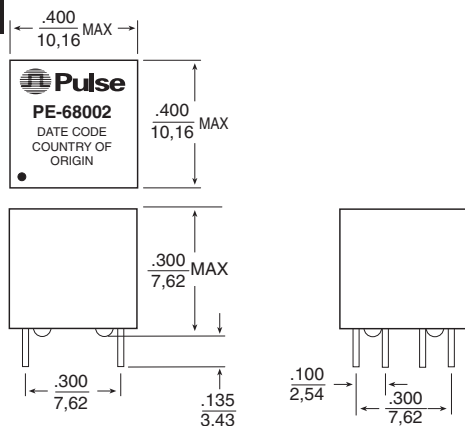

Dimensions: $\frac{\text{Inches}}{\text{mm}}$
Unless otherwise specified,
all tolerances are $\pm \frac{.010}{0,25}$

PE-68002

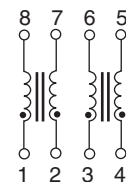

Weight1.4 grams
Tube50/tube

THROUGH HOLE COMMON MODE CHOKES

Suited for LAN and Telecom Applications



Mechanicals

Schematics

B2005

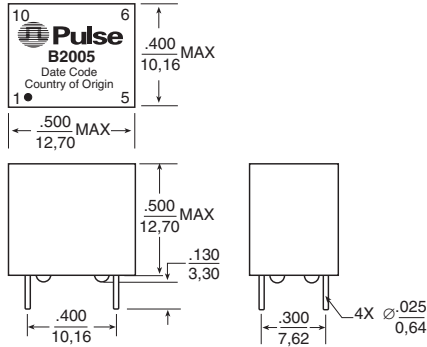

Dimensions: Inches
mm
Unless otherwise specified,
all tolerances are ± .005
0,13

Weight 3.7 grams
Tube40/tube



23Z104

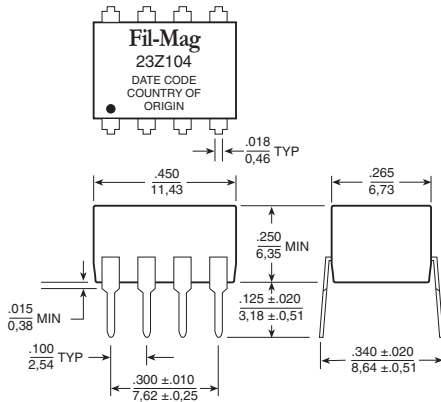

Dimensions: Inches
mm
Unless otherwise specified,
all tolerances are ± .005
0,13

Weight 1.0 grams
Tube50/tube

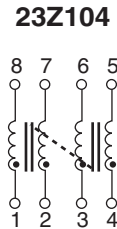

23Z107

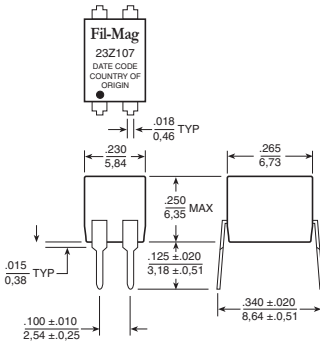

Dimensions: Inches
mm
Unless otherwise specified,
all tolerances are ± .005
0,13

Weight 0.45 grams
Tube100/tube

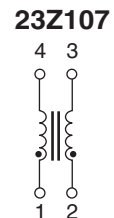

42Z4000

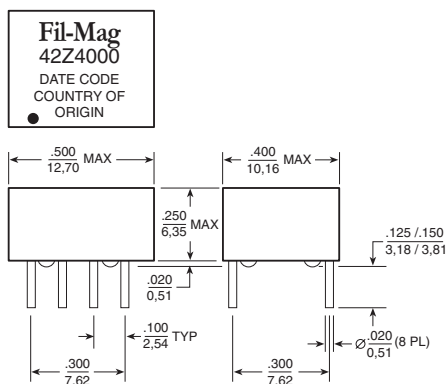

Dimensions: Inches
mm
Unless otherwise specified,
all tolerances are ± .010
0,25

Weight 1.5 grams
Tube47/tube

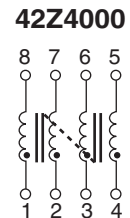

THROUGH HOLE COMMON MODE CHOKES

Suited for LAN and Telecom Applications



Pulse
A TECHNITROL COMPANY

Mechanicals

Schematics

PE-68613

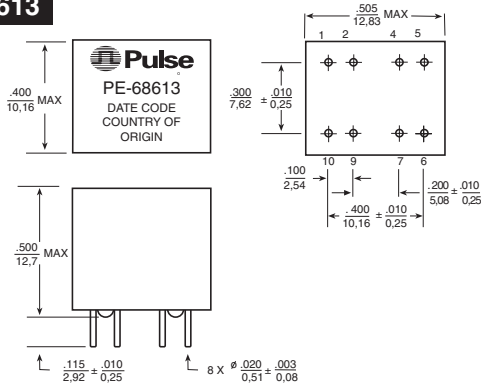

Dimensions: Inches
mm
Unless otherwise specified,
all tolerances are ± .005
0,127

Weight 3.5 grams
Tube40/tube

PE-68613

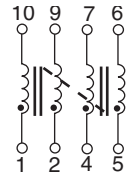

J0010D11 - Filtered Connector

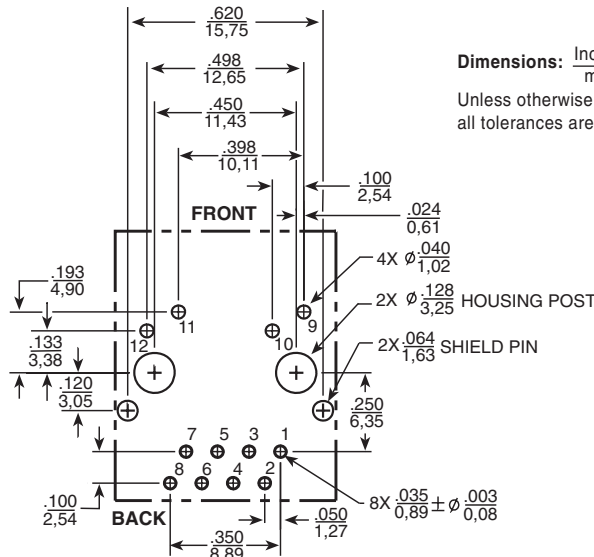
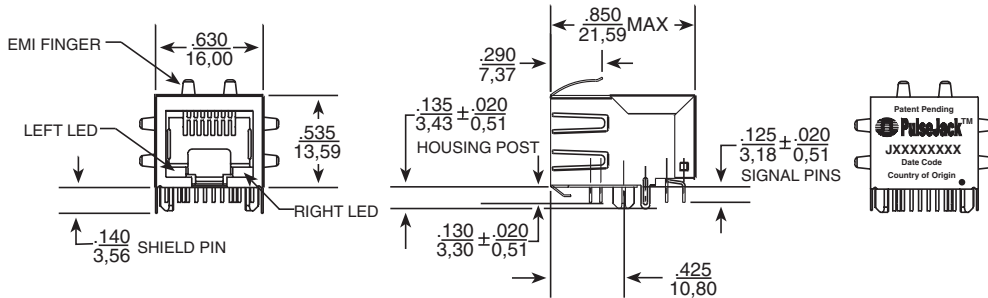

Dimensions: Inches
mm
Unless otherwise specified,
all tolerances are ± .010
0,25

THROUGH HOLE COMMON MODE CHOKES

Suited for LAN and Telecom Applications



Common Mode Test Circuit for Surface Mount and Through Hole

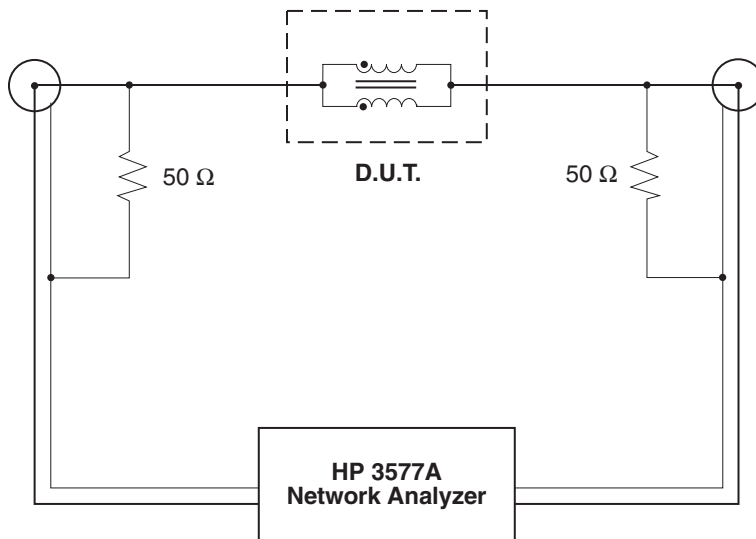

Test Notes:

1. Network analyzer calibrated to compensate for 50 Ω resistors.
2. All windings on a core are connected in parallel for the test.
3. For multi-core chokes, test data is for one core only. The windings on the other core(s) are left unconnected (i.e. open).

For More Information:

Pulse Worldwide Headquarters

12220 World Trade Dr.
San Diego, CA 92128
U.S.A.

www.pulseeng.com

Pulse European Headquarters

Einsteinstrasse 1
71083 Herrenberg
Germany

Pulse China Headquarters

B402, Shenzhen
Tech-Innovation International
10th Kejinan Rd.
High-Tech Industrial Park
Nanshan District, Shenzhen
China

Pulse North China

Room 1503
XinYin Building
No. 888 YiShan Road
Shanghai 200233
China

Pulse South Asia

150 Kampong Ampat
#07-01/02
KA Centre
Singapore 368324

Pulse North Asia

No. 26
Kao Ching Road
Yang Mei Chen
Taoyuan Hsien
Taiwan, R. O. C.

TEL: 858 674 8100

FAX: 858 674 8262

TEL: 49 7032 7806 0

FAX: 49 7032 7806 12

TEL: 86 755 33966678

FAX: 86 755 33966700

TEL: 86 21 54643211/2

FAX: 86 21 54643210

TEL: 65 6287 8998

FAX: 65 6280 0080

TEL: 886 3 4641811

FAX: 886 3 4641911

Performance warranty of products offered on this data sheet is limited to the parameters specified. Data is subject to change without notice. Other brand and product names mentioned herein may be trademarks or registered trademarks of their respective owners.

© Copyright, 2007. Pulse Engineering, Inc. All rights reserved.