

Features

- Diffused Junction
- Low Leakage
- Low Cost
- High Surge Current Capability
- Typical I_R less than 200nA

Mechanical Data

- Case: Copper Case and Components Hermetically Sealed
- Terminals: Insulated Wire with Washer Lead
- Polarity: Cathode to Case (Reverse Units Are Available Upon Request and Are Designated By A "R" Suffix, i.e. PFW5020R or PFW5024R)
- Polarity: Red Color Equals Standard, Black Color Equals Reverse Polarity
- Mounting Position: Any
- **Lead Free: For RoHS / Lead Free Version, Add "-LF" Suffix to Part Number, See Page 2**

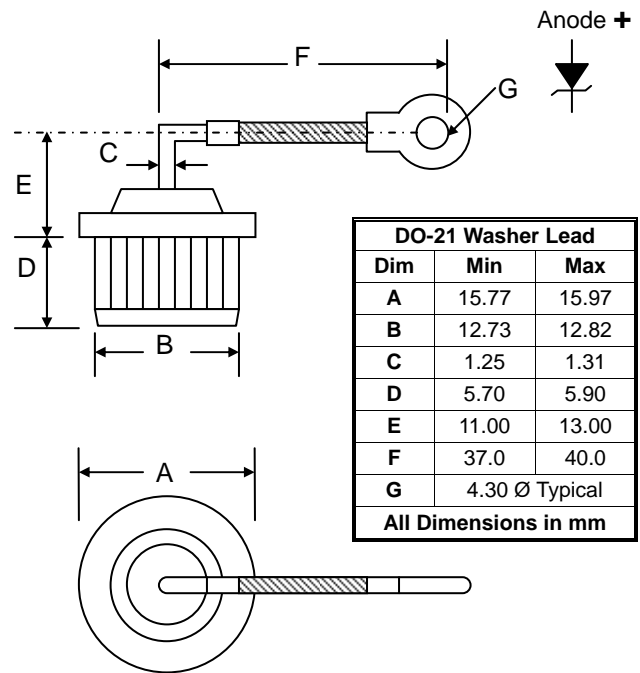

Maximum Ratings and Electrical Characteristics @ $T_A=25^\circ\text{C}$ unless otherwise specified

Single Phase, half wave, 60Hz, resistive or inductive load.
For capacitive load, derate current by 20%.

Characteristic	Symbol	PFW5020	PFW5024	PFW5036	Unit
Peak Repetitive Reverse Voltage	V_{RRM}	16	20	32	V
Working Peak Reverse Voltage	V_{RWM}				
DC Blocking Voltage	V_R				
Average Rectified Output Current @ $T_C = 150^\circ\text{C}$	I_O	50			A
Breakdown Voltage Min. @ $I_R = 100\text{mA}$	V_{BR}	20	24	36	V
Breakdown Voltage Max. @ $I_R = 100\text{mA}$		26	32	42	
Non-Repetitive Peak Forward Surge Current 8.3ms Single Half Sine-Wave Superimposed on Rated Load (JEDEC Method)	I_{FSM}	500			A
Forward Voltage @ $I_F = 50\text{A}$	V_{FM}	1.0			V
Peak Reverse Current At Rated DC Blocking Voltage @ $T_A = 25^\circ\text{C}$	I_{RM}	200			nA
Typical Junction Capacitance (Note 1)	C_J	400			pF
Typical Thermal Resistance (Note 2)	R_{JC}	1.0			$^\circ\text{C/W}$
Operating and Storage Temperature Range	T_J, T_{STG}	-65 to +175			$^\circ\text{C}$

Note: 1. Measured at 1.0 MHz and applied reverse voltage of 4.0V D.C.
2. Thermal Resistance: Junction to case, single side cooled.

ORDERING INFORMATION

Product No.	Package Type	Shipping Quantity
PFW5020	DO-21 Washer Lead Press-Fit	100 Units/Box
PFW5024	DO-21 Washer Lead Press-Fit	100 Units/Box
PFW5036	DO-21 Washer Lead Press-Fit	100 Units/Box

1. Shipping quantity given is for minimum packing quantity only. For minimum order quantity, please consult the Sales Department.
2. **To order Lead Free version (with Lead Free finish), add "-LF" suffix to part number above. For example, PFW5020-LF.**

WON-TOP ELECTRONICS and  are registered trademarks of Won-Top Electronics Co., Ltd (WTE). WTE has checked all information carefully and believes it to be correct and accurate. However, WTE cannot assume any responsibility for inaccuracies. Furthermore, this information does not give the purchaser of semiconductor devices any license under patent rights to manufacturer. WTE reserves the right to change any or all information herein without further notice.

WARNING: DO NOT USE IN LIFE SUPPORT EQUIPMENT. WTE power semiconductor products are not authorized for use as critical components in life support devices or systems without the express written approval.

Won-Top Electronics Co., Ltd.
No. 44 Yu Kang North 3rd Road,
Chine Chen Dist., Kaohsiung 806, Taiwan
Phone: 886-7-822-5408 or 886-7-822-5410
Fax: 886-7-822-5417
Email: sales@wontop.com
Internet: <http://www.wontop.com>

We power your everyday.