

### ■ Absolute Maximum Ratings

Ta = 25°C

		Pure Green	Green	Yellow		Orange	Red	Units
		BG	PG	PY	AY	AA	BR	
Power Dissipation	Pd	70	70	70	70	70	57.5	mW
Forward Current	IF	25	25	25	25	25	25	mA
Peak Forward Current	IFM	60	60	60	60	60	60	mA
Reverse Voltage	VR	4	4	4	4	4	4	V
Operating Temp.	Topr	-30~+85	-30~+85	-30~+85	-30~+85	-30~+85	-30~+85	°C
Storage Temp.	Tstg	-40~+100	-40~+100	-40~+100	-40~+100	-40~+100	-40~+100	°C
Derating *	ΔIF	0.36						mA/°C

\* The current derating for operation applies when temperature is above 25°C.

• IFM Condition : tw ≤ 1ms, Duty ≤ 1/20

### ■ Electro-Optical Characteristics

Ta = 25°C

Part No.	Chip		Lens Color	Luminous Intensity			Wavelength				Forward Voltage			Reverse Current		
	Material	Emitted Color		Iv			λ d	λ p		Δλ		VF			IR	
				MIN	TYP	IF	TYP	TYP	TYP	IF	TYP	MAX	IF	MAX	VR	
BG1111C	GaP	Pure Green	White Milky	1.4	2.4	20	558	555	30	20	2.1	2.8	20	100	4	
PG1111C	GaP	Green		3.8	6.4	20	567	560	30	20	2.1	2.8	20	100	4	
PY1111C	GaP	Yellow		7.0	11.7	20	572	570	30	20	2.1	2.8	20	100	4	
AY1111C	GaAsP			2.0	3.4	20	590	580	30	20	2.2	2.8	20	100	4	
AA1111C	GaAsP	Orange		2.0	3.4	20	605	605	30	20	2.2	2.8	20	100	4	
BR1111C	GaAlAs	Red		7.0	11.7	20	647	660	30	20	1.7	2.3	20	100	4	
Units			mcd	mcd	mA	nm	nm	nm	mA	V	V	mA	μA	V		

### ■ Package Dimensions

Unit : mm

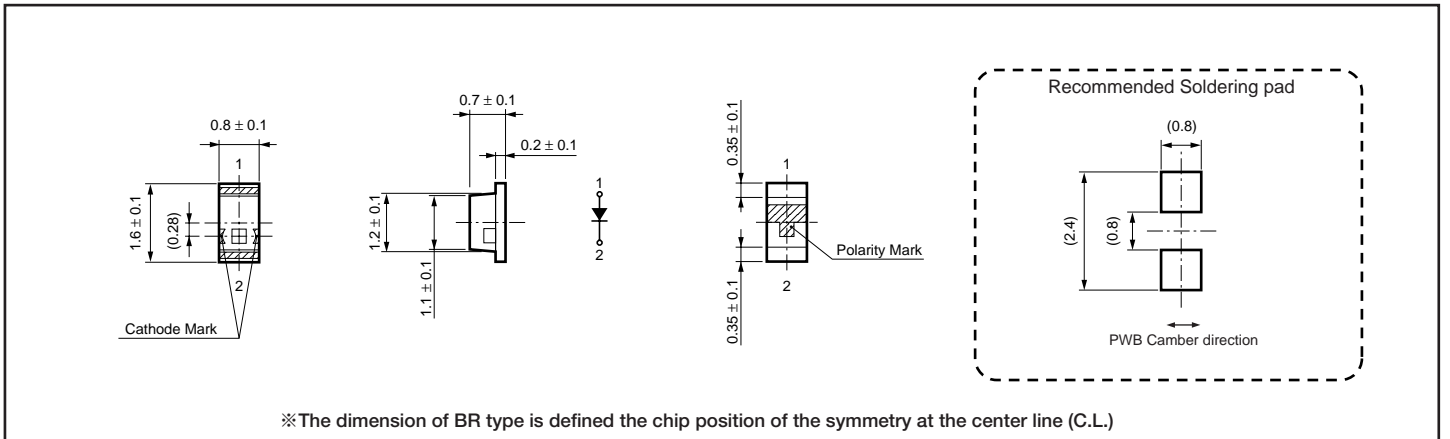

### ■ Spatial Distribution

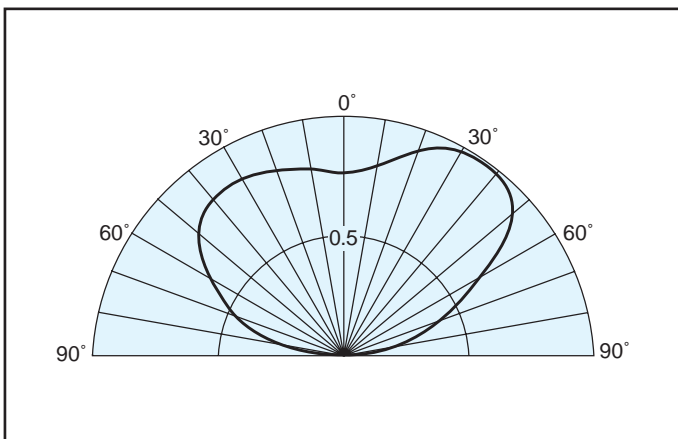

### ■ Taping Specification

Unit : mm

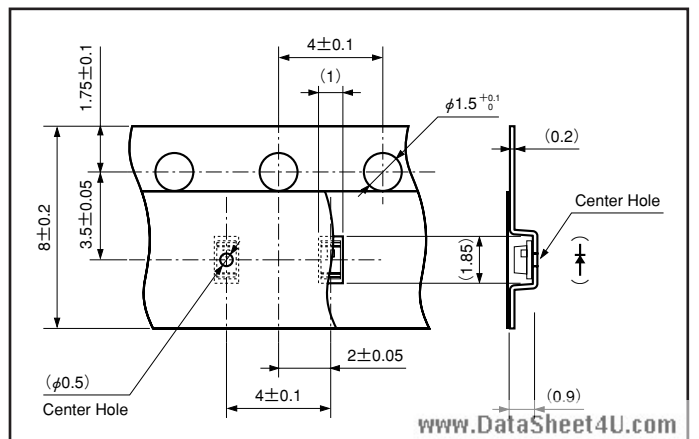

\* Quantity 4,000 pcs/Reel

■ Power Dissipation vs. Ambient Temperature

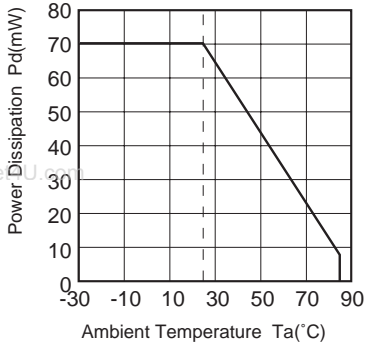

■ Ambient Temperature vs. Maximum Forward Current

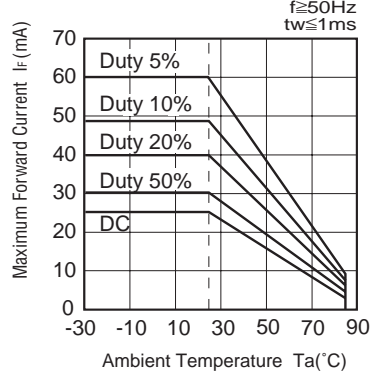

■ Pulse Duration vs. Maximum Tolerable Peak Current

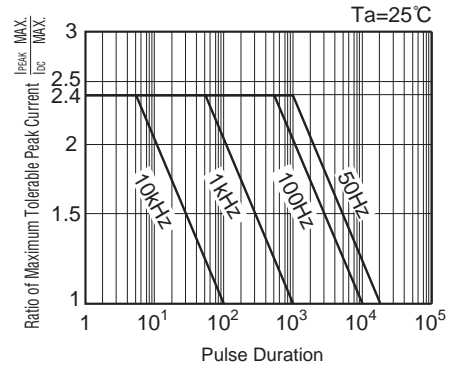

■ Forward Voltage vs. Forward Current

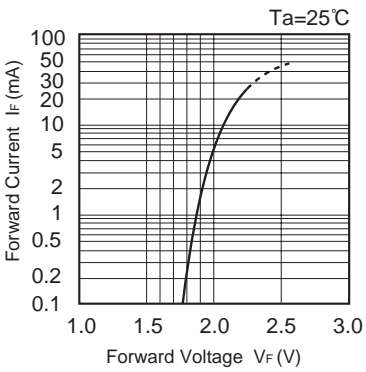

■ Forward Current vs. Relative Intensity

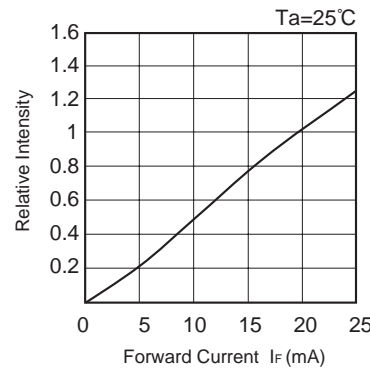

■ Ambient Temperature vs. Relative Intensity

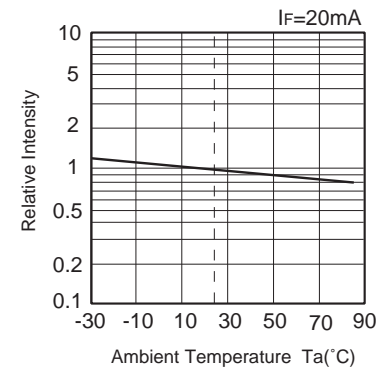

■ Spectral Distribution

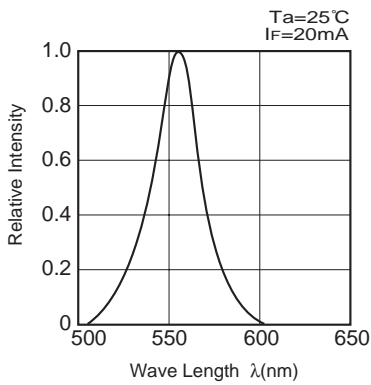

■ Power Dissipation vs. Ambient Temperature

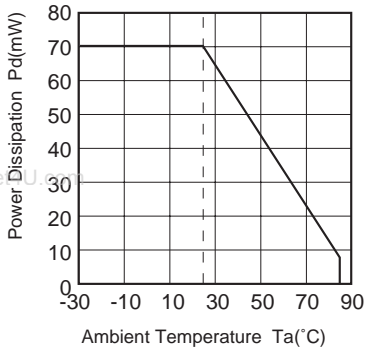

■ Ambient Temperature vs. Maximum Forward Current

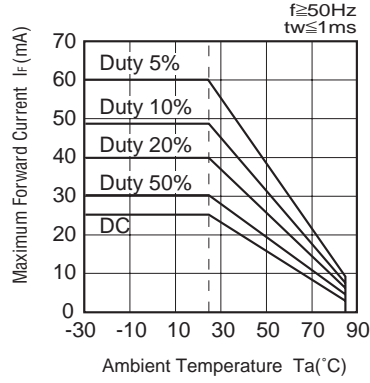

■ Pulse Duration vs. Maximum Tolerable Peak Current

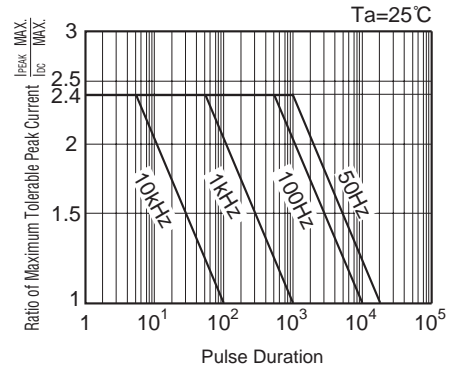

■ Forward Voltage vs. Forward Current

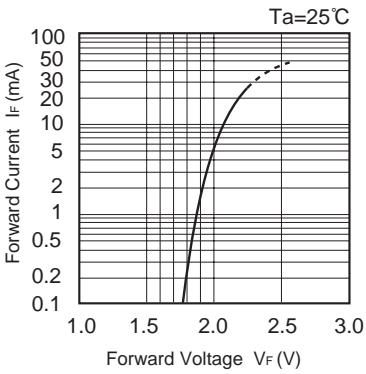

■ Forward Current vs. Relative Intensity

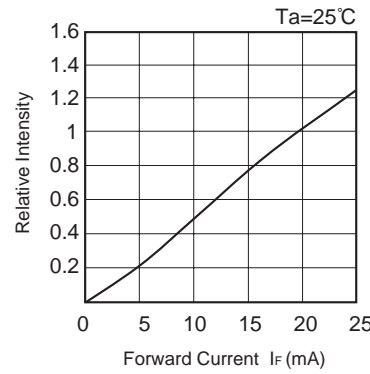

■ Ambient Temperature vs. Relative Intensity

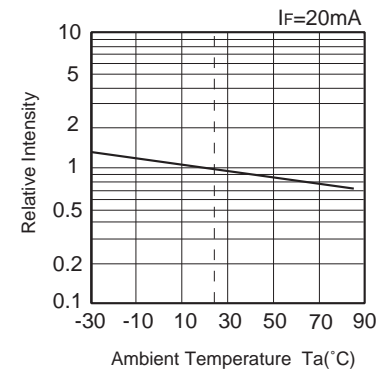

■ Spectral Distribution

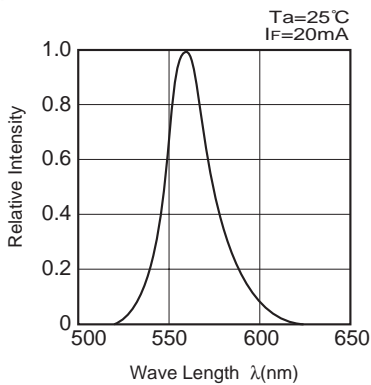

### ■ Power Dissipation vs. Ambient Temperature

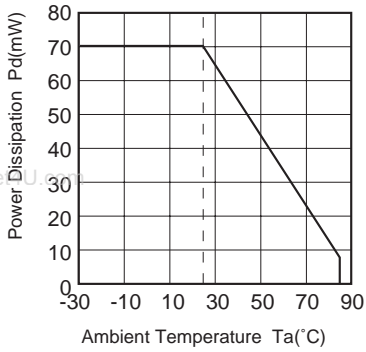

### ■ Ambient Temperature vs. Maximum Forward Current

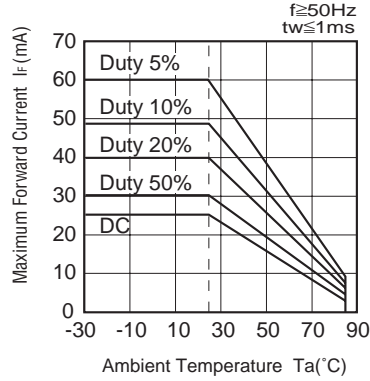

### ■ Pulse Duration vs. Maximum Tolerable Peak Current

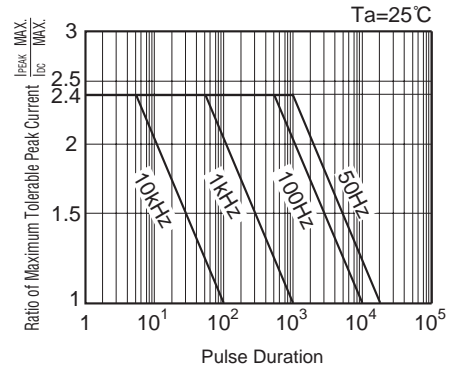

### ■ Forward Voltage vs. Forward Current

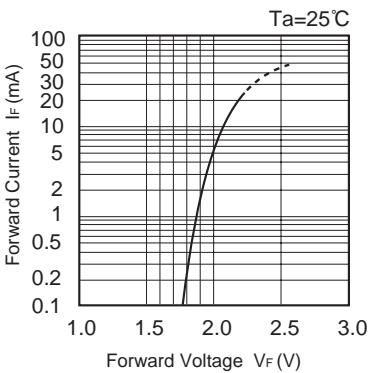

### ■ Forward Current vs. Relative Intensity

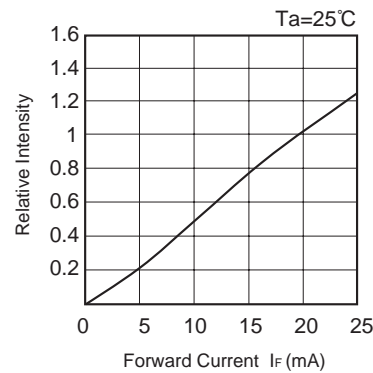

### ■ Ambient Temperature vs. Relative Intensity

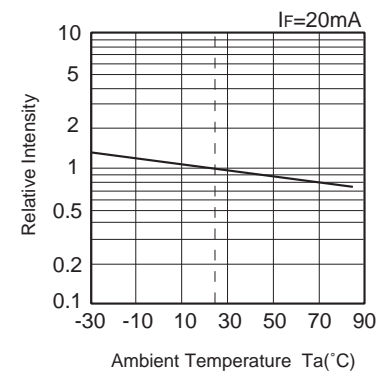

### ■ Spectral Distribution

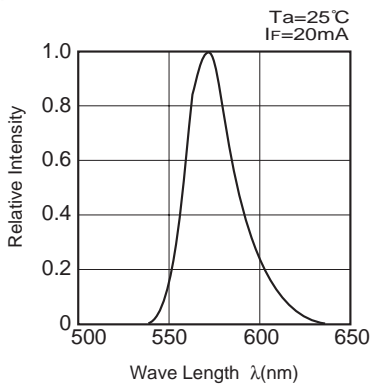

■ Power Dissipation vs. Ambient Temperature

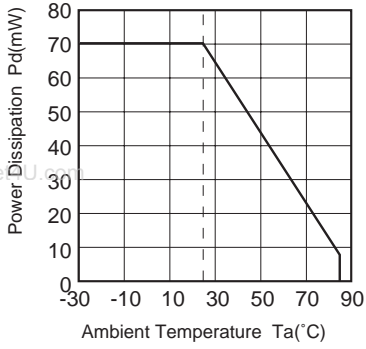

■ Ambient Temperature vs. Maximum Forward Current

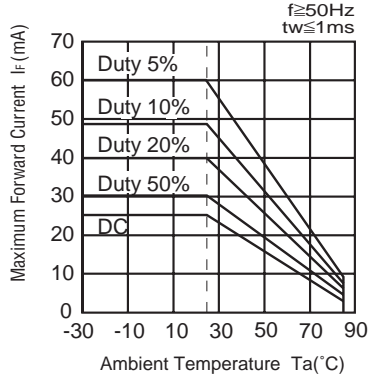

■ Pulse Duration vs. Maximum Tolerable Peak Current

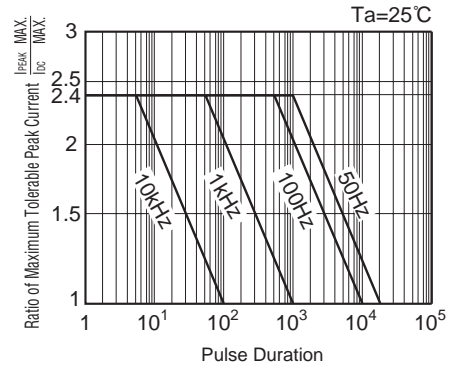

■ Forward Voltage vs. Forward Current

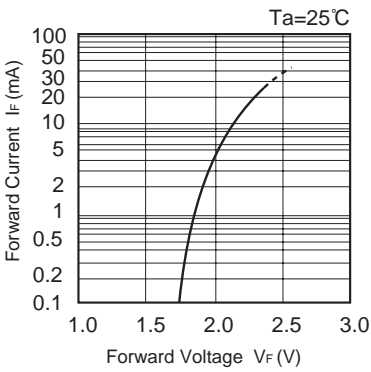

■ Forward Current vs. Relative Intensity

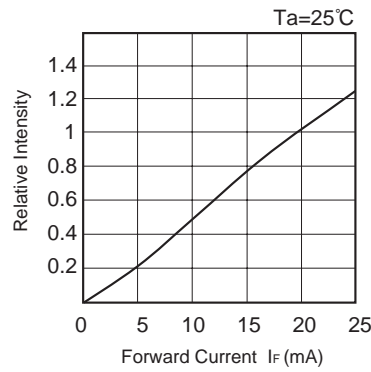

■ Ambient Temperature vs. Relative Intensity

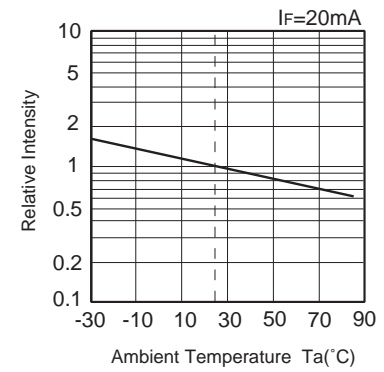

■ Spectral Distribution

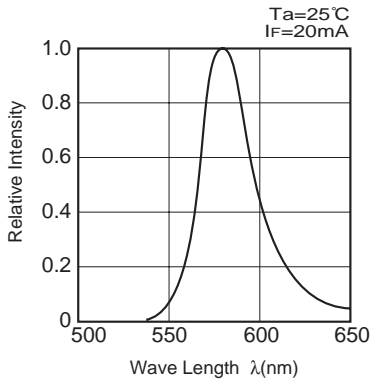

■ Power Dissipation vs. Ambient Temperature

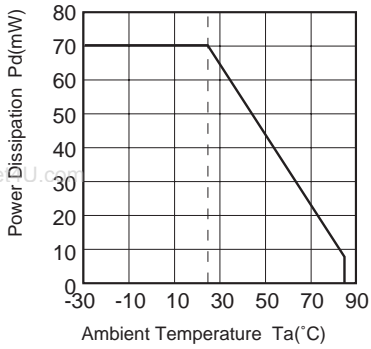

■ Ambient Temperature vs. Maximum Forward Current

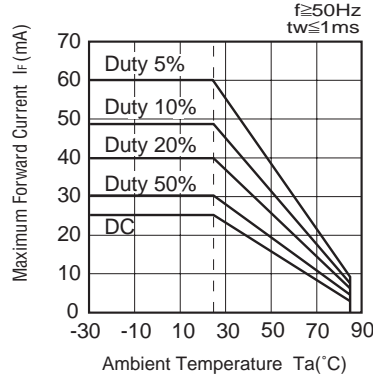

■ Pulse Duration vs. Maximum Tolerable Peak Current

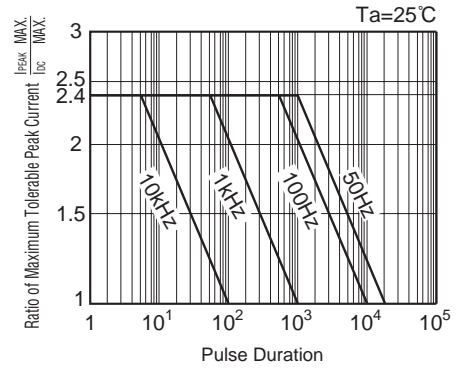

■ Forward Voltage vs. Forward Current

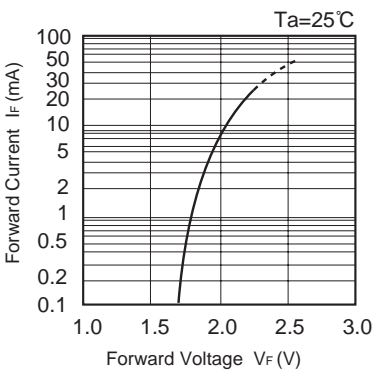

■ Forward Current vs. Relative Intensity

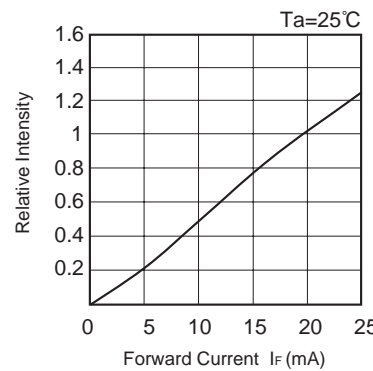

■ Ambient Temperature vs. Relative Intensity

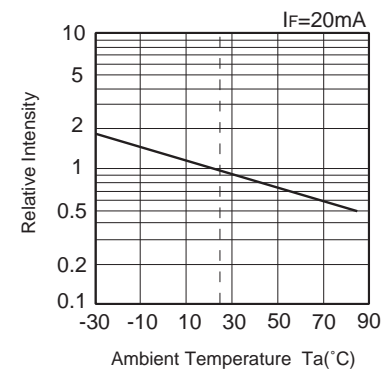

■ Spectral Distribution

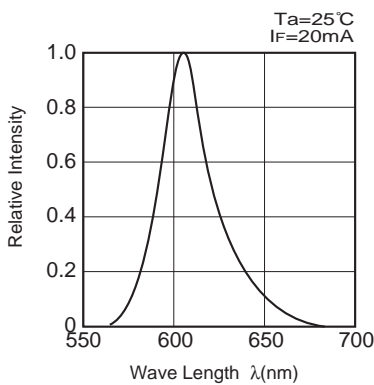

■ Power Dissipation vs. Ambient Temperature

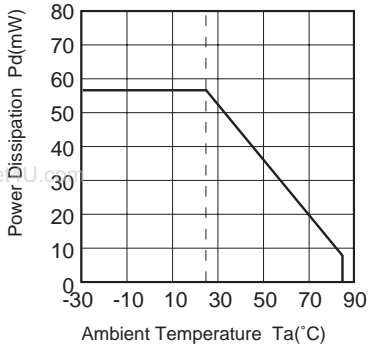

■ Ambient Temperature vs. Maximum Forward Current

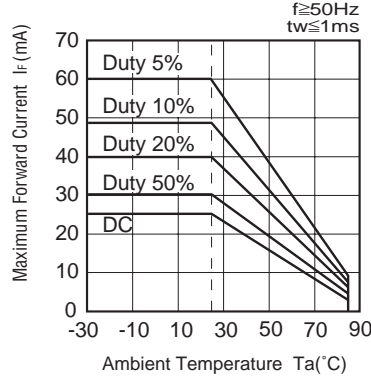

■ Pulse Duration vs. Maximum Tolerable Peak Current

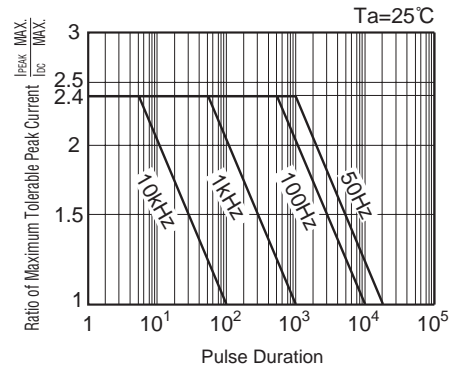

■ Forward Voltage vs. Forward Current

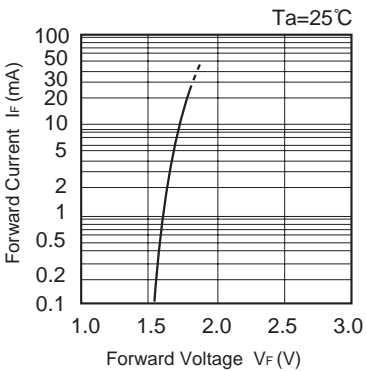

■ Forward Current vs. Relative Intensity

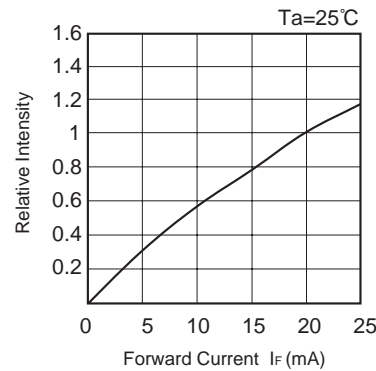

■ Ambient Temperature vs. Relative Intensity

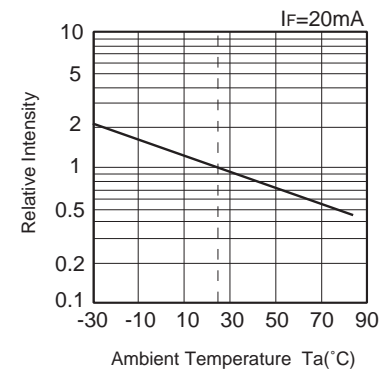

■ Spectral Distribution

