

Bi-directional ESD / Transient Protection Diodes

FEATURES

- Transient protection for data lines to
 - IEC61000-4-2(ESD) : Air mode $\pm 30\text{kV}$ / Contact mode $\pm 30\text{kV}$
 - IEC61000-4-5(Surge) : $3\text{A}(t_p=8/20 \mu\text{s})$
- Bi-directional working voltage up to : $V_{RWM} = 24\text{V}$
- Small Size $2.9 \times 1.6 \times 1.3\text{mm}$
- Qualified to AEC-Q101



SOT-23 (SMD-type)

PRODUCT DESCRIPTION

- Molding compound flammability rating : UL 94V-0
- Pb-Free, Halogen-Free, RoHs Compliant

Package dimensions (SOT-23)	Pin configurations (Bi-directional)																																		
<table border="1" style="margin-left: auto; margin-right: auto;"> <thead> <tr> <th>DIM</th> <th>MILLIMETERS</th> </tr> </thead> <tbody> <tr><td>A</td><td>2.93±0.20</td></tr> <tr><td>B</td><td>1.30+0.20/-0.15</td></tr> <tr><td>C</td><td>1.30 MAX</td></tr> <tr><td>D</td><td>0.40+0.15/-0.05</td></tr> <tr><td>E</td><td>2.40+0.30/-0.20</td></tr> <tr><td>G</td><td>1.90</td></tr> <tr><td>H</td><td>0.95</td></tr> <tr><td>J</td><td>0.13+0.10/-0.05</td></tr> <tr><td>K</td><td>0.00 ~ 0.10</td></tr> <tr><td>L</td><td>0.55</td></tr> <tr><td>M</td><td>0.20 MIN</td></tr> <tr><td>N</td><td>1.00+0.20/-0.10</td></tr> <tr><td>P</td><td>7°</td></tr> <tr><td>Q</td><td>0.1 MAX</td></tr> </tbody> </table>	DIM	MILLIMETERS	A	2.93±0.20	B	1.30+0.20/-0.15	C	1.30 MAX	D	0.40+0.15/-0.05	E	2.40+0.30/-0.20	G	1.90	H	0.95	J	0.13+0.10/-0.05	K	0.00 ~ 0.10	L	0.55	M	0.20 MIN	N	1.00+0.20/-0.10	P	7°	Q	0.1 MAX	<table border="1" style="margin-left: auto; margin-right: auto; text-align: center;"> <thead> <tr> <th>Pin</th> <th>Identification</th> </tr> </thead> <tbody> <tr> <td>1, 2, 3</td> <td>CATHODE</td> </tr> </tbody> </table>	Pin	Identification	1, 2, 3	CATHODE
DIM	MILLIMETERS																																		
A	2.93±0.20																																		
B	1.30+0.20/-0.15																																		
C	1.30 MAX																																		
D	0.40+0.15/-0.05																																		
E	2.40+0.30/-0.20																																		
G	1.90																																		
H	0.95																																		
J	0.13+0.10/-0.05																																		
K	0.00 ~ 0.10																																		
L	0.55																																		
M	0.20 MIN																																		
N	1.00+0.20/-0.10																																		
P	7°																																		
Q	0.1 MAX																																		
Pin	Identification																																		
1, 2, 3	CATHODE																																		

ORDERING INFORMATION

Part Number	Qty per Reel	Reel Size	Marking code
PG24DAS23-RTK/H	3,000	7 inch	QD

PG24DAS23

MAXIMUM RATING (Ta=25)

CHARACTERISTIC	SYMBOL	RATING	UNIT
Peak Pulse Power (tp=8/20 μs)	P _{PK}	120	W
Peak Pulse Current (tp=8/20 μs)	I _{PP}	3	A
Junction Temperature	T _J	150	
Storage Temperature	T _{STG}	-55 150	

DEFINITIONS OF ELECTRICAL CHARACTERISTIC SYMBOL

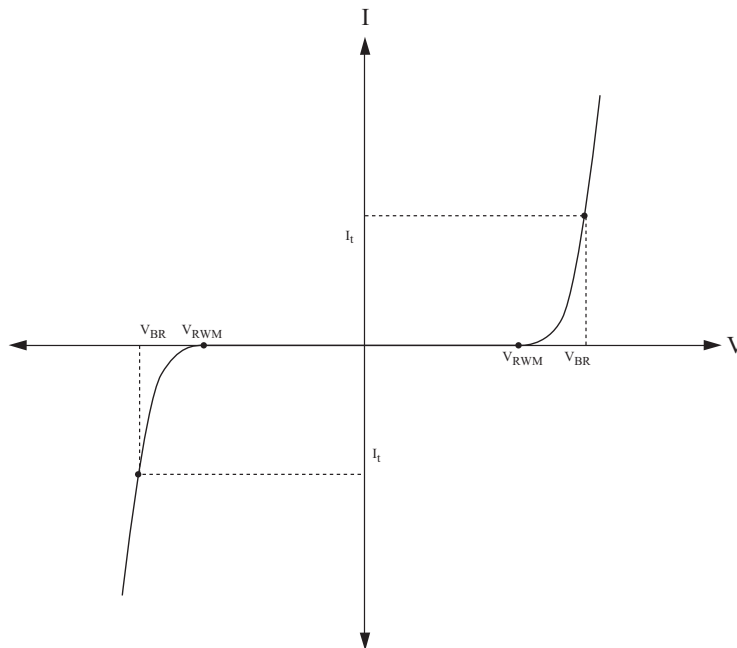

ELECTRICAL CHARACTERISTICS (Ta=25)

CHARACTERISTIC	SYMBOL	TEST CONDITION	MIN.	TYP.	MAX.	UNIT
Reverse Stand-Off Voltage	V _{RWM}	-	-	-	24	V
Reverse Leakage Current	I _R	V _{RWM} =24V	-	-	100	nA
Reverse Breakdown Voltage	V _{BR}	I _t =1mA	25	-	33	V
Total Capacitance	C _T	V _R =0V, f=1MHz (Any I/O pin to ground)	-	-	17	pF
Clamping Voltage	V _C	I _{PP} =1A, tp=8/20 μs (IEC61000-4-5)	-	-	36	V
		I _{PP} =3A, tp=8/20 μs (IEC61000-4-5)	-	-	40	
Electrostatic Discharge	V _{ESD}	IEC61000-4-2	Air	± 30	-	kV
			Contact	± 30		

PG24DAS23

NON-REPETITIVE PEAK PULSE POWER VS. PULSE TIME

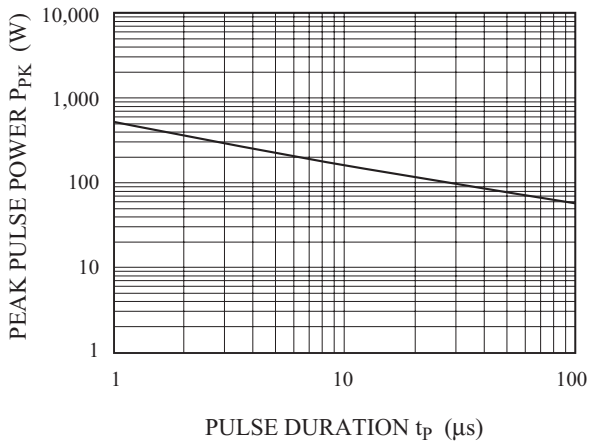

POWER DERATION CURVE

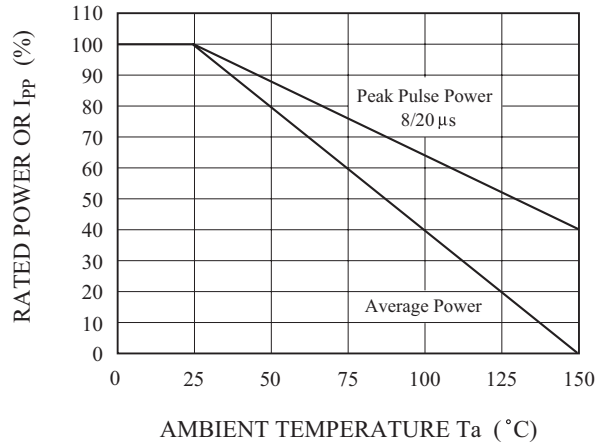

$I_R - V_{BR}$

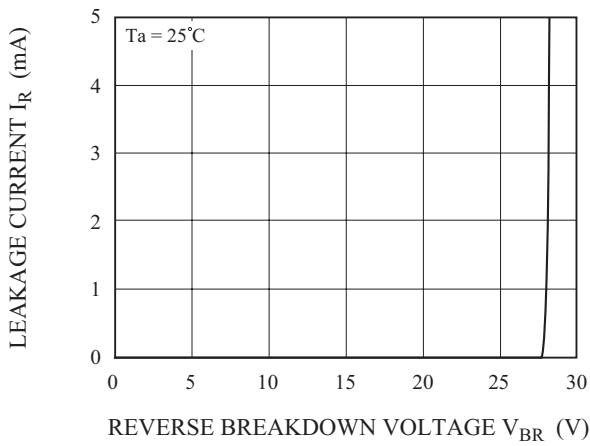

$I_R - V_R$

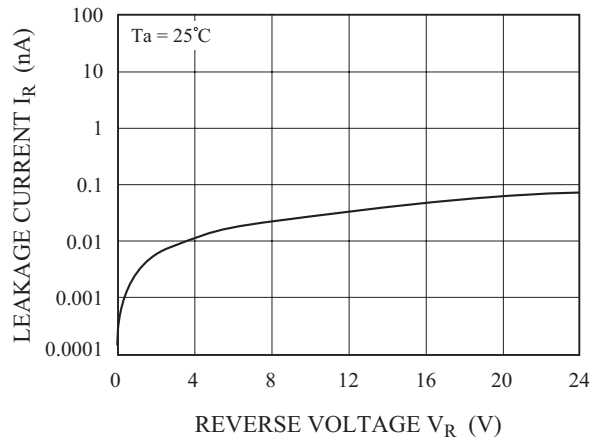

$C_T - V_R$

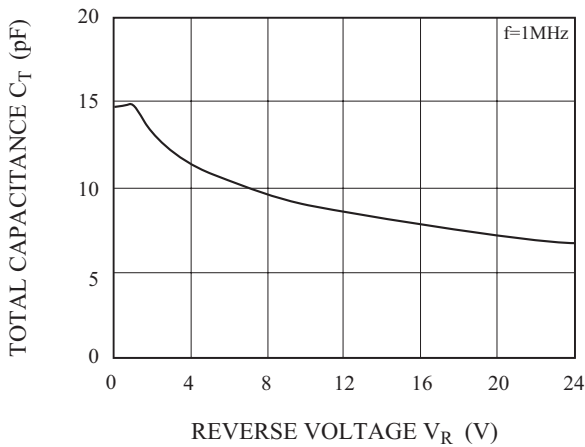

$I_{PP} - V_C$

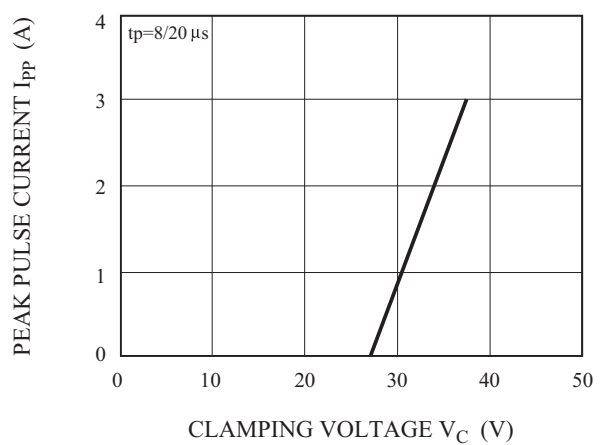

PULSE WAVEFORM

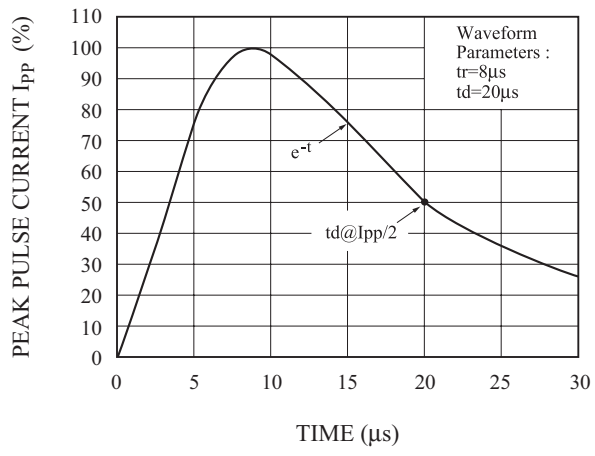

APPLICATIONS

- Low and high speed CAN
- Automotive application

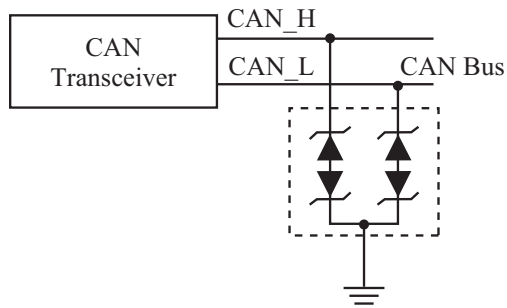

Figure 1. Low and high speed CAN TVS Protection Circuit

Recommended pad dimension & Marking Information

Recommended pad dimension	Marking Code