

PGA100

Digitally-Controlled Programmable Gain/Multiplexed Input OPERATIONAL AMPLIFIER

FEATURES

- HIGH GAIN ACCURACY, $\pm 0.02\%$, max (B grade)
- LOW NONLINEARITY, $\pm 0.005\%$, max (B grade)
- FAST SETTLING, $5\mu\text{sec}$ to 0.01%
- LOW CHANNEL-TO-CHANNEL CROSSTALK, $\pm 0.003\%$
- INPUT PROTECTION, $\pm 20\text{V}$, max above $\pm V_{CC}$
- 8 ANALOG INPUT CHANNELS WITH HIGH Z_{IN} , $10^{11}\Omega$
- 8 BINARY GAINS 1, 2, 4, 8, 16, 32, 64, 128 (V/V)
- FULLY MICROPROCESSOR-COMPATIBLE

APPLICATIONS

- DATA ACQUISITION SYSTEM AMPLIFIER
- SOFTWARE ERROR CORRECTION
- AUTO-ZEROING CAPABILITY
- DIGITALLY-CONTROLLED AUTORANGING SYSTEM
- TEST EQUIPMENT
- REMOTE INSTRUMENTATION SYSTEM
- SYSTEM DYNAMIC RANGE AND RESOLUTION IMPROVEMENT

DESCRIPTION

The PGA100 is a precision, digitally-programmable-gain multiplexed-input amplifier. The user can select any one of eight analog input channels simultaneously with any one of eight noninverting binarily weighted gain steps from 1 to 128 (V/V). The digital gain and channel select are latching for microprocessor interface. Also, the fast $5\mu\text{sec}$ settling time is ideal for rapid channel scanning in data acquisition systems.

Precision laser-trimming of both offset voltage and

gain accuracy, with good temperature tracking of feedback resistor ratios, permits direct use without adjustments. However, hardware or software correction of errors is readily achievable.

In addition, gain scaling to gains other than 1 to 128V/V can easily be accomplished.

Microcircuit construction and the use of laser-trimmed thin-film feedback resistors achieve high accuracy, small size, and low cost not obtained with discrete designs.

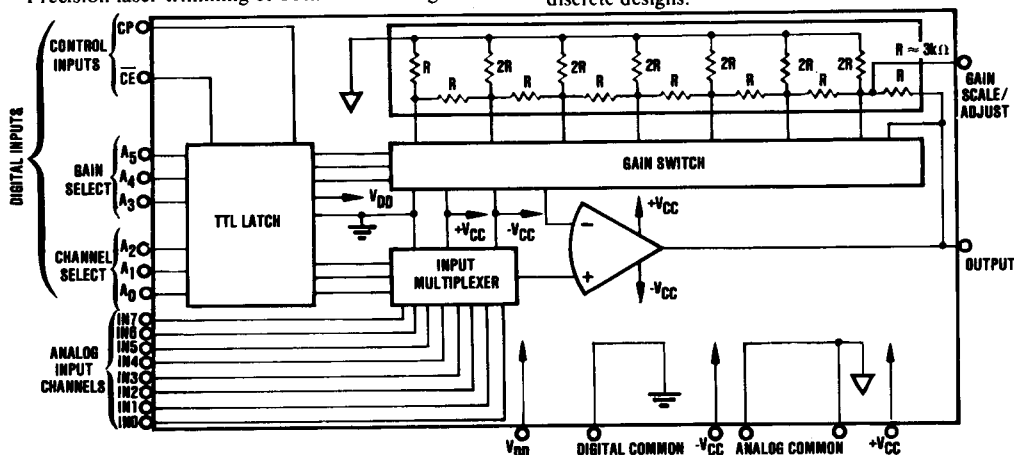

International Airport Industrial Park - P.O. Box 11400 - Tucson, Arizona 85734 - Tel. (602) 746-1111 - Twx: 910-952-1111 - Cable: BBRCORP - Telex: 66-6491

PDS-457B

SPECIFICATIONS

ELECTRICAL

Specifications at $T_A = +25^\circ\text{C}$, $\pm V_{CC} = 15\text{VDC}$, $V_{DD} = +5\text{VDC}$ unless otherwise noted.

| PARAMETER | CONDITIONS | PGA100AG | | | PGA100BG | | | UNITS |
|---|---|----------|--|------------------------|----------|------------------|------------------|--|
| | | MIN | TYP | MAX | MIN | TYP | MAX | |
| GAIN, G | | | | | | | | |
| Inaccuracy ⁽¹⁾ vs Temperature ⁽²⁾ vs Time | $G = 1$ to 128 , $I_o = 1\text{mA}$ $-25^\circ\text{C} \leq T_A \leq +85^\circ\text{C}$ | | ± 0.01 ± 5 ± 0.001 | ± 0.05 ± 10 | | ± 0.005 . | ± 0.02 . | % ppm/ $^\circ\text{C}$ %/1000 hrs. |
| Nonlinearity ⁽³⁾ vs Temperature ⁽²⁾ vs Time | $G = 1$ to 128 , $I_o = 1\text{mA}$ $-25^\circ\text{C} \leq T_A \leq +85^\circ\text{C}$ | | ± 0.004 ± 0.001 | ± 0.01 ± 5 | | ± 0.002 . | ± 0.005 . | % of FS ppm/ $^\circ\text{C}$ %/1000 hrs. |
| Warm-up Time | | 1 | | | . | | | min |
| RATED OUTPUT | | | | | | | | |
| Voltage | $I_o = \pm 2\text{mA}$ | ± 10 | | | . | | | V |
| Current | $V_o = \pm 10\text{V}$ | ± 2 | | | . | | | mA |
| Output Resistance | $G \leq 128$ | | 0.05 | | . | | | Ω |
| Short Circuit Current | | | ± 15 | | . | | | mA |
| Capacitive Load Range | Phase Margin $\geq 25^\circ$ | | 1000 | | . | | | pF |
| INPUT OFFSET VOLTAGE | | | | | | | | |
| Initial vs Temperature vs Supply Voltage vs Time | $T_A = +25^\circ\text{C}$ $-25^\circ\text{C} \leq T_A \leq +85^\circ\text{C}$ $\pm 8\text{VDC} \leq V_{CC} \leq \pm 18\text{VDC}$ | | ± 0.1 ± 6 ± 10 ± 15 | ± 1 ± 80 | | ± 0.05 . | ± 0.5 . | mV $\mu\text{V}/^\circ\text{C}$ $\mu\text{V/V}$ $\mu\text{V}/\text{mo.}$ |
| INPUT BIAS CURRENT | | | | | | | | |
| Initial "OFF" Channel "ON" Channel vs Temperature | $T_A = +25^\circ\text{C}$ | | ± 10 ± 0.1 Note 4 | | | . | ± 1 | pA nA |
| INPUT DIFFERENCE CURRENT, BETWEEN CHANNELS | | | | | | | | |
| Initial "OFF" Channel "ON" Channel vs Temperature | $T_A = +25^\circ\text{C}$ | | ± 20 ± 0.2 Note 4 | | | . | ± 2 | pA nA |
| ANALOG INPUT CHARACTERISTICS | | | | | | | | |
| Absolute Max Voltage | No damage | | | | | | | V |
| Input Voltage Range | Linear operation | ± 10 | | $\pm (V_{CC} + 20)$ | | | | V |
| Input Impedance | | | | | | | | |
| "OFF" Channel | | | $10^{12} \parallel 5$ | | | . | | $\Omega \parallel \text{pF}$ |
| "ON" Channel | | | $10^{11} \parallel 25$ | | | . | | $\Omega \parallel \text{pF}$ |
| INPUT NOISE | | | | | | | | |
| Voltage Noise Density | $f_o = 1\text{Hz}$ $f_o = 10\text{Hz}$ $f_o = 100\text{Hz}$ $f_o = 1\text{kHz}$ $f_o = 10\text{kHz}$ $f_o = 100\text{kHz}$ | | 200 60 25 18 18 18 | | | . | | nV/ $\sqrt{\text{Hz}}$ nV/ $\sqrt{\text{Hz}}$ nV/ $\sqrt{\text{Hz}}$ nV/ $\sqrt{\text{Hz}}$ nV/ $\sqrt{\text{Hz}}$ nV/ $\sqrt{\text{Hz}}$ |
| Voltage Noise | $f_B = 0.1\text{Hz}$ to 10Hz | | 2.6 | | | . | | nV/ $\sqrt{\text{Hz}}$ |
| Current Noise Density | $f_o = 0.1\text{Hz}$ thru 8kHz | | 6 | | | . | | μV , p-p |
| Current Noise | $f_B = 0.1\text{Hz}$ to 10Hz | | 115 | | | . | | fA/ $\sqrt{\text{Hz}}$ fA, p-p |
| DYNAMIC RESPONSE | | | | | | | | |
| Gain Bandwidth Product | | | 5 | | | . | | MHz |
| Full Power Bandwidth | $G = 1$, $V_o = 20\text{V}$, p-p, $R_L = 5\text{k}\Omega$ | | 220 | | 80 | . | | kHz |
| Slew Rate | $G = 1$, $V_o = \pm 10\text{V}$, $R_L = 5\text{k}\Omega$ | | 14 | | 5 | . | | V/ μsec |
| Settling Time ⁽⁵⁾ $\epsilon = 1\%$ $\epsilon = 0.1\%$ $\epsilon = 0.01\%$ | $G = 1$, $V_o = \pm 10\text{V}$, $R_L = 5\text{k}\Omega$ | | 2.5 3 5 | | | . | | μsec μsec μsec |
| Rise Time | 10% to 90%, small signal $G = 1$, $R_L = 5\text{k}\Omega$ | | 70 | | | . | | nsec |
| Phase Margin | | | 60 | | | . | | Degrees |
| Overload Recovery ⁽⁶⁾ | $G = 1$, 50% overdrive | | 2 | | | . | | μsec |
| Crosstalk, RTI ⁽⁵⁾⁽⁷⁾ | 20V, p-p, 1kHz sine, $R_S = 1\text{k}\Omega$ on all OFF channels | | ± 0.003 | | | . | | % |
| DIGITAL INPUT⁽⁸⁾ | | | | | | | | |
| Input "Low" Threshold, V_{IL} | | | 2.0 | | 0.8 | . | | V |
| Input "High" Threshold, V_{IH} | | | | | | . | | V |
| f_{max} , Maximum Clock Frequency | | | 30 | | | . | | MHz |
| t_{WL} , Clock Pulse Width (Low) | Figure 1 | | 20 | | | . | | nsec |
| t_{s1} , Setup Time (Data to CP) | Figure 1 | | 20 | | | . | | nsec |
| t_{h1} , Hold Time (Data to CP) | Figure 1 | | 5 | | | . | | nsec |
| t_{s2} , Setup Time (CE to CP) | Figure 1 | | 25 | | | . | | nsec |
| t_{h2} , Hold Time (CE to CP) | Figure 1 | | 5 | | | . | | nsec |

ELECTRICAL (CONT)

| PARAMETER | CONDITIONS | PGA100AG | | | PGA100BG | | | UNITS |
|----------------------------|--------------------------|----------|-----|-------|----------|------|-----|-------|
| | | MIN | TYP | MAX | MIN | TYP | MAX | |
| ANALOG SUPPLY | | | | | | | | |
| Rated Voltage | Derated performance | ±8 | ±15 | ±18 | . | . | . | VDC |
| Voltage Range | | | +20 | +27 | | -15 | +20 | V |
| Positive Quiescent Current | | | -10 | -16 | | -7.5 | -12 | mA |
| Negative Quiescent Current | | | | | | | | mA |
| DIGITAL SUPPLY | | | | | | | | |
| Rated Voltage | V _{DD} = +5.25V | +4.75 | +5 | +5.25 | . | . | . | VDC |
| Voltage Range | | | 15 | 27 | | | | V |
| Quiescent Current | | | | | | | | mA |
| TEMPERATURE RANGE | | | | | | | | |
| Specification | Derated performance | -25 | | -85 | . | . | . | °C |
| Operating | | | -55 | | -125 | . | . | °C |
| Storage | | | -55 | | -125 | . | . | °C |

*Specifications same as PGA100AG

NOTES:

- Inaccuracy is the percent error between the actual and ideal gain selected. It may be externally adjusted to zero.
- Parameter is untested and is not guaranteed. This specification is established to a 90% confidence level.
- Nonlinearity is the maximum peak deviation from a "best straight line" (curve fitting on input-output graph) expressed as a percent of the full scale peak-to-peak output. Gain constant, V_{out} ranges from -10V to +10V.
- Doubles approximately every 10°C.
- See Typical Performance Curves.
- Time required for the output to return from saturation to linear operation following the removal of an input overdrive signal.
- Crosstalk is the amount of signal feedthrough from all OFF channels that appears at the output of the input multiplexer. It is expressed as a percent of the signal applied to all OFF channels.
- All digital inputs are one 74LSTTL load.

ABSOLUTE MAXIMUM RATINGS

| | |
|---|--------------------------|
| Analog Supply | ±18V |
| Digital Supply | +7V |
| Input Voltage Range, Analog | ±(V _{CC} + 20)V |
| Input Voltage Range, Digital | +7V |
| Storage Temperature Range | -55°C to +125°C |
| Lead Temperature (soldering 10 seconds) | 300°C |
| Output Short-circuit Duration | Continuous to ground |
| Junction Temperature | 175°C |

PIN DESIGNATIONS

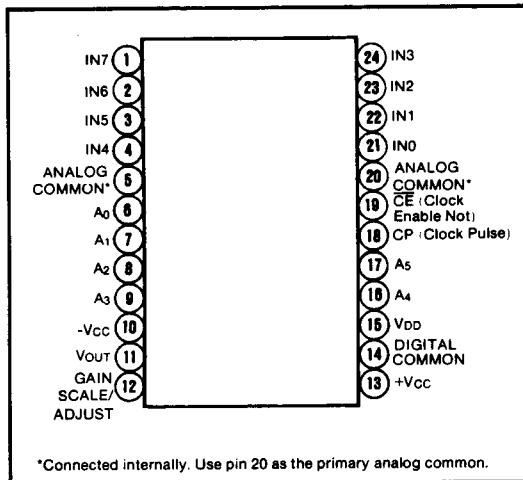

MECHANICAL

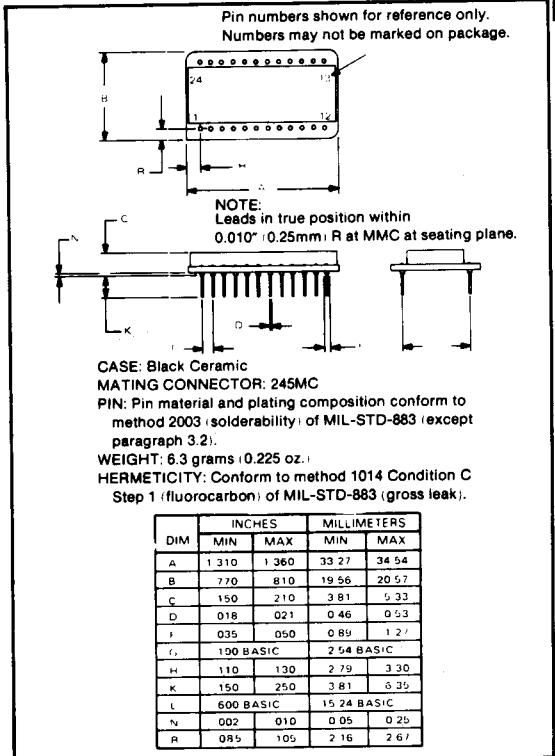

CASE: Black Ceramic
 MATING CONNECTOR: 245MC
 PIN: Pin material and plating composition conform to method 2003 (solderability) of MIL-STD-883 (except paragraph 3.2).
 WEIGHT: 6.3 grams (0.225 oz.)
 HERMETICITY: Conform to method 1014 Condition C Step 1 (fluorocarbon) of MIL-STD-883 (gross lead).

| DIM | INCHES | | MILLIMETERS | |
|-----|-----------------------|-------|-------------|-------|
| | MIN | MAX | MIN | MAX |
| A | 1.310 | 1.360 | 33.27 | 34.54 |
| B | 7.70 | 8.10 | 19.56 | 20.57 |
| C | 1.50 | 2.10 | 3.81 | 5.33 |
| D | 0.18 | 0.21 | 0.46 | 0.53 |
| E | 0.35 | 0.50 | 0.89 | 1.27 |
| F | 100 BASIC 2.54 BASIC | | | |
| H | 1.10 | 1.30 | 2.79 | 3.30 |
| K | 1.50 | 2.50 | 3.81 | 6.35 |
| L | 600 BASIC 15.24 BASIC | | | |
| M | 0.02 | 0.10 | 0.05 | 0.25 |
| R | 0.85 | 1.05 | 2.16 | 2.67 |

ORDERING INFORMATION

| Model | Package | Temperature Range |
|--|---------|-------------------------------------|
| PGA100AG | Ceramic | -25°C to +85°C |
| PGA100BG | Ceramic | -25°C to +85°C |
| BURN-IN SCREENING OPTION See text for details. | | |
| Model | Package | Burn-In Temp. (160h) ⁽¹⁾ |
| PGA100AG-BI | Ceramic | +125°C |
| PGA100BG-BI | Ceramic | +125°C |

NOTE: (1) Or equivalent combination. See text.

TYPICAL PERFORMANCE CHARACTERISTICS CURVES

($T_A = +25^\circ\text{C}$, $\pm V_{CC} = 15\text{VDC}$, $V_{DD} = +5\text{VDC}$, unless otherwise noted.)

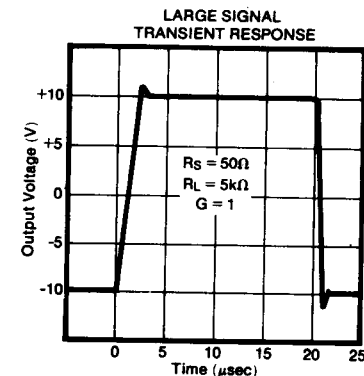
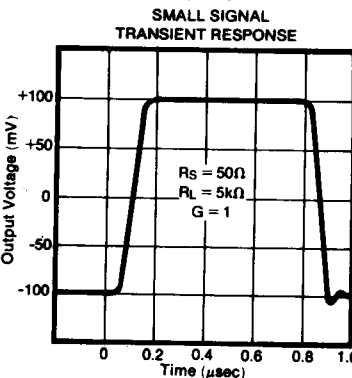
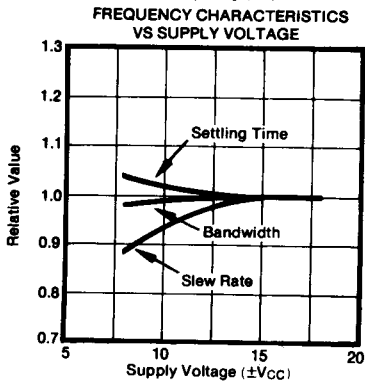
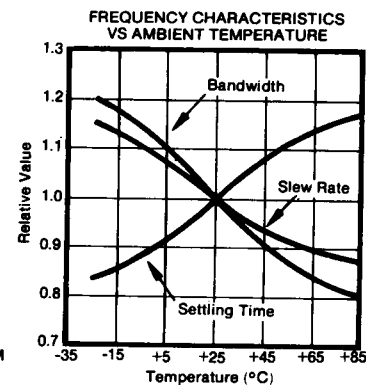
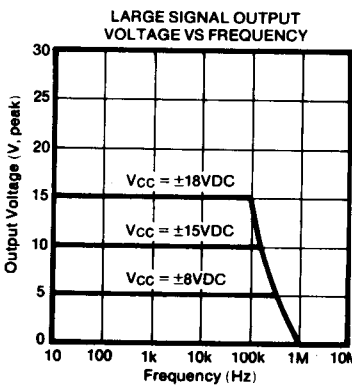
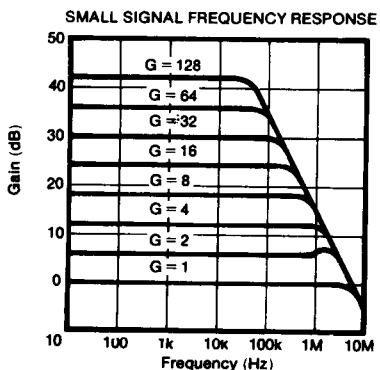
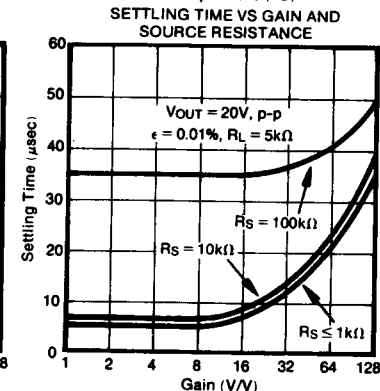
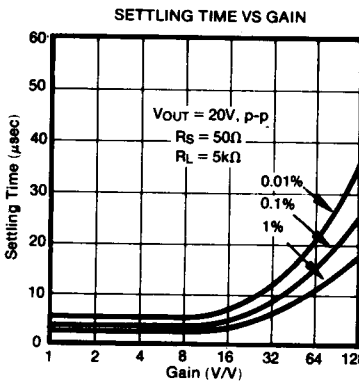
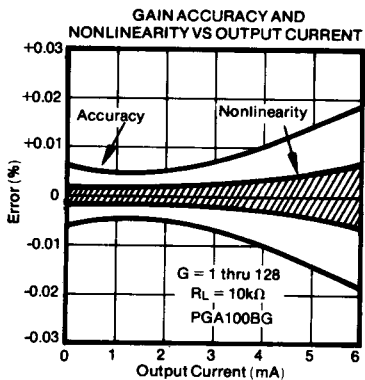
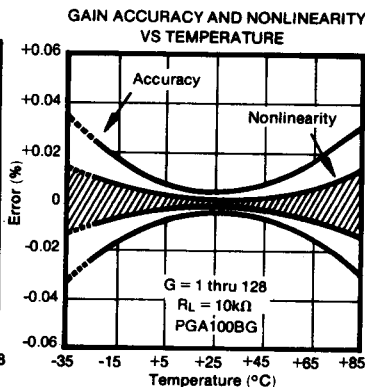
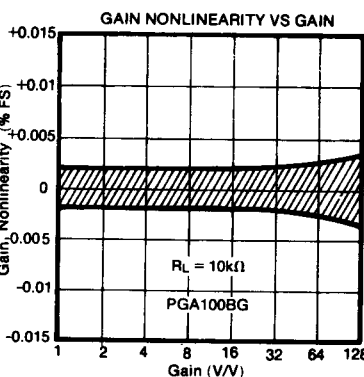
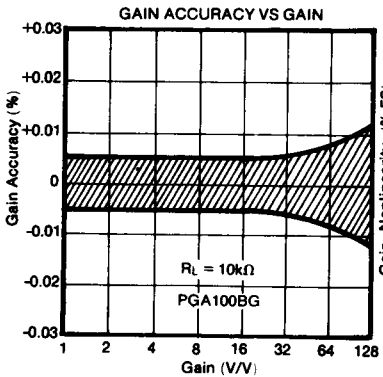

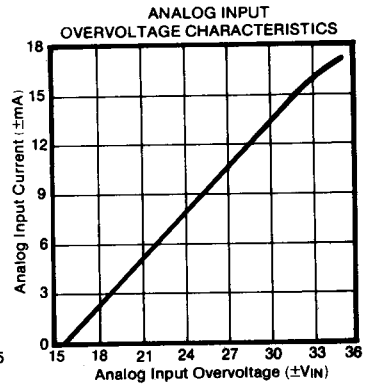
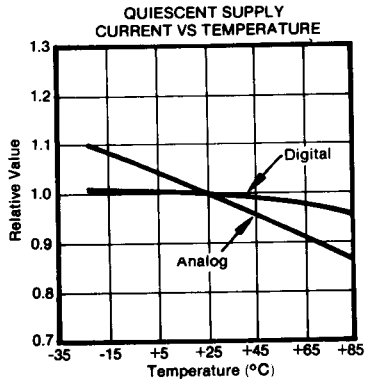
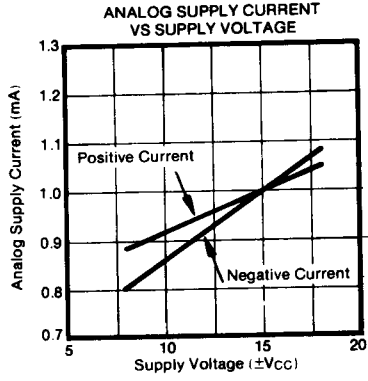
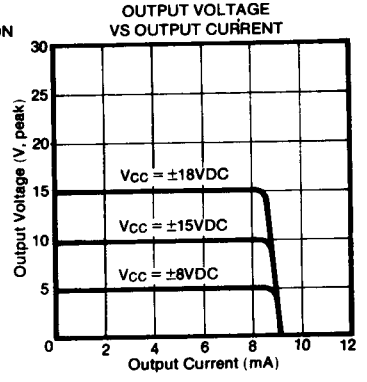
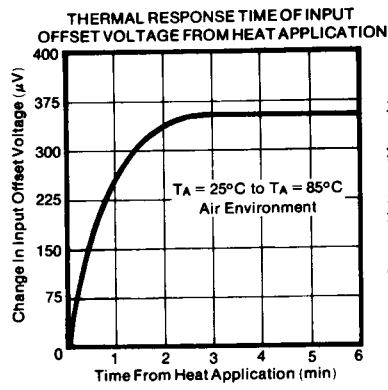
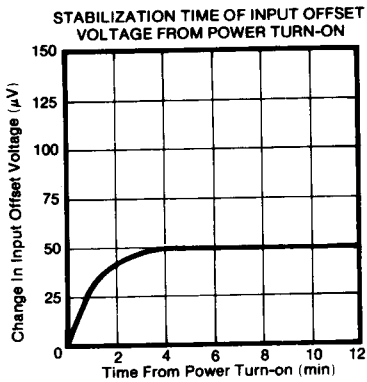
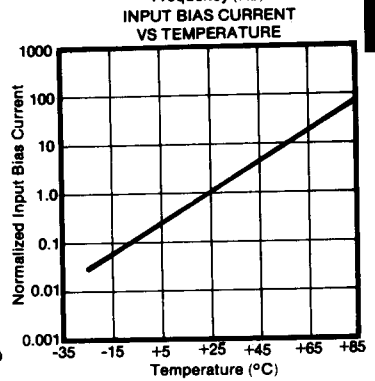
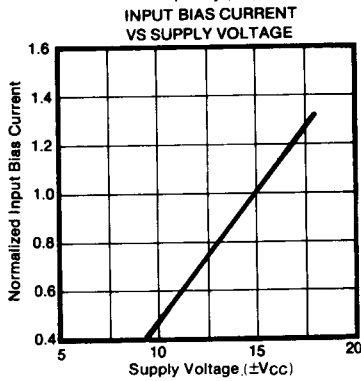
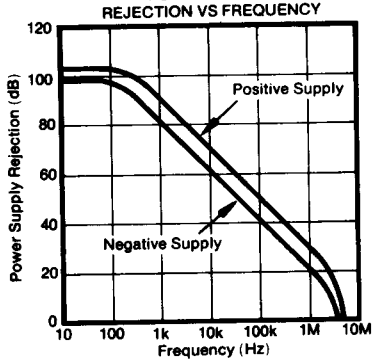
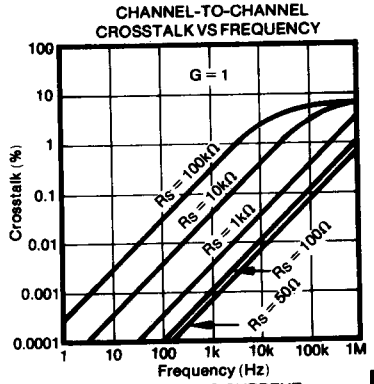
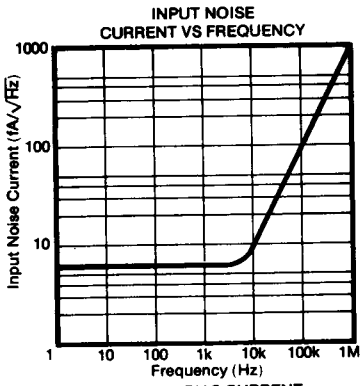
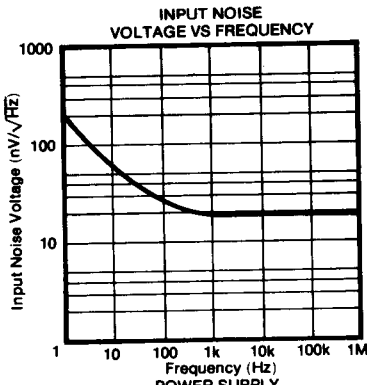

BURN-IN SCREENING

Burn-in screening is an option available for the PGA100. Burn-in duration is 160 hours at the temperature shown below (or equivalent combination of time and temperature).

Plastic "-BI" models: +85°C

Ceramic "-BI" models: +125°C

All units are tested after burn-in to ensure that grade specifications are met. To order burn-in, add "-BI" to the base model number.

DISCUSSION OF PERFORMANCE

The PGA100 is a self-contained programmable-gain amplifier whose gain can be changed in 8 binary weighted steps from 1 to 128 or as scaled externally through the gain scale/adjust pin. The gain control is accomplished by the gain switch (break-before-make) whose position is determined by the 3-bit TTL address, A_3 , A_4 , and A_5 . When selected, 1 of 8 positions connects the thin-film resistor network to the feedback loop of the op amp. This establishes the desired gain. (See Installation and Operating Instructions for gain scaling.)

Similarly, the 8 analog input channels are switched by the input multiplexer (break-before-make) whose position is determined by the 3-bit TTL address, A_0 , A_1 , and A_2 . Gain and channel selection appear in Table I. 64-channel gain combinations are possible.

The digital inputs are latched by the positive transition of the clock pulse, pin 18, when the clock enable, pin 19, is low. The relative set up and holding times specified in the Electrical Specifications are shown in Figure 1. The internal latch is similar to the industry standard 74LS378. Figure 2 shows a timing diagram for selected addresses indicating: the enable function, changing channel and

TABLE I. Gain and Channel Select Truth Table.

| GAIN SELECT | | | GAIN | CHANNEL SELECT | | | CHANNEL |
|-------------|-------|-------|------|----------------|-------|-------|---------|
| A_5 | A_4 | A_3 | | A_2 | A_1 | A_0 | |
| 0 | 0 | 0 | 1 | 0 | 0 | 0 | IN0 |
| 0 | 0 | 1 | 2 | 0 | 0 | 1 | IN1 |
| 0 | 1 | 0 | 4 | 0 | 1 | 0 | IN2 |
| 0 | 1 | 1 | 8 | 0 | 1 | 1 | IN3 |
| 1 | 0 | 0 | 16 | 1 | 0 | 0 | IN4 |
| 1 | 0 | 1 | 32 | 1 | 0 | 1 | IN5 |
| 1 | 1 | 0 | 64 | 1 | 1 | 0 | IN6 |
| 1 | 1 | 1 | 128 | 1 | 1 | 1 | IN7 |

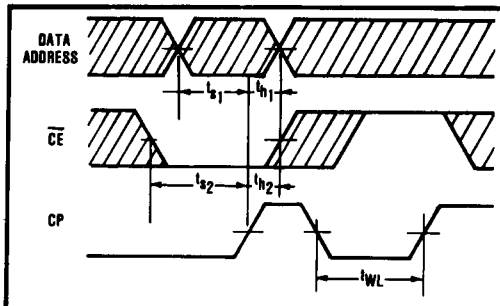

FIGURE 1. Data Address and Clock Enable Setup and Hold Times.

gain, changing channel constant gain, and constant channel changing gain.

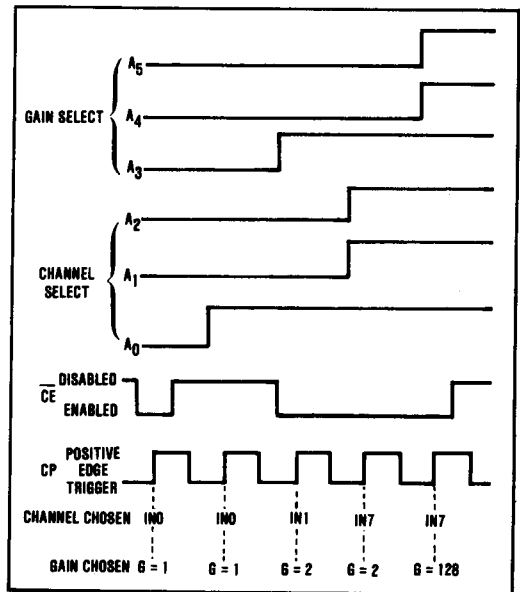

FIGURE 2. Timing Diagram for Selected Addresses.

INSTALLATION AND OPERATING INSTRUCTIONS

POWER SUPPLY AND SIGNAL CONNECTIONS

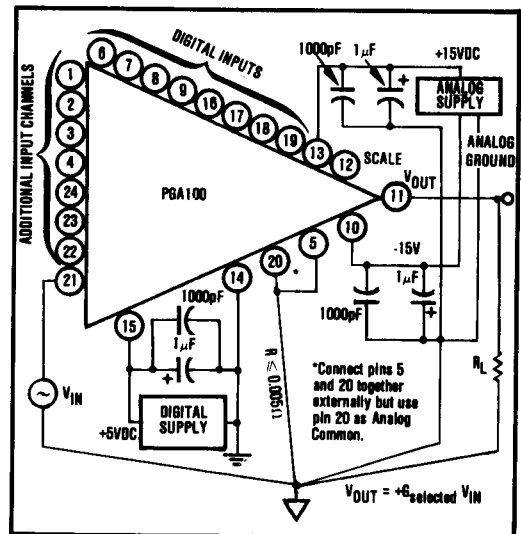

FIGURE 3. Basic Power Supply, Ground, and Signal Connections.

Figure 3 shows the proper analog and digital power supply connections. The supplies should be decoupled with $1\mu\text{F}$ tantalum and 1000pF ceramic capacitors as close to the amplifier as possible. To avoid gain errors connect grounds as indicated being sure to minimize ground resistance. Note that a resistance of greater than

0.005Ω in series with the analog common will degrade the specified gain accuracy. **IMPORTANT:** Normally the digital ground is brought in from the digital power supply on a separate line. However, the analog and digital commons must be connected together somewhere in the system.

OPTIONAL GAIN SCALE/ADJUST

The gain scale/adjust pin is shown in Figure 4. When no connection is made, gains appear as in Table I. At least two functions can be performed. First, the gain range can be scaled to gains other than 1 to 128, for example, 1 to 100 or 1 to 1024. Gain steps, however, retain binary weighting. Some examples are: (1, 1, 2, 4, 8, 16, 32, 64 with pins 11 and 12 connected together), (1, 1.5625, 3.125, 6.25, 12.5, 25, 50, 100), (1, 12.5, 25, 50, 100, 200, 400, 800), and (1, 16, 32, 64, 128, 256, 512, 1024). Scaling is accomplished by using a potentiometer, R_1 , shown in Figure 4. Be certain to use a potentiometer of good mechanical and thermal stability. Additional gain drift with temperature should be minimal since it depends on the thermal tracking of the resistance ratio, R_A to R_B , set by the potentiometer.

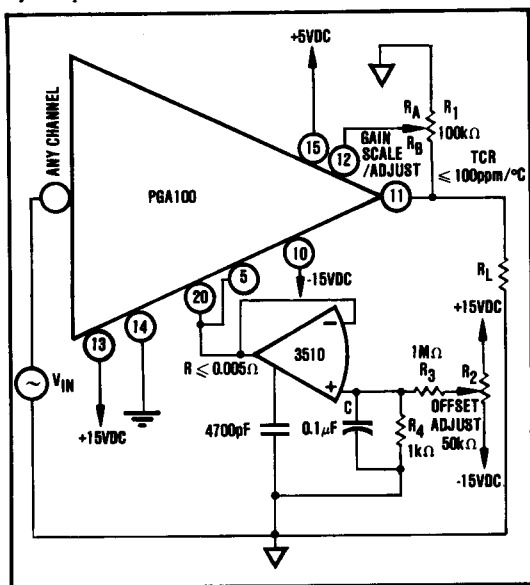

FIGURE 4. External Gain and Offset Adjustment.

Second, the gain inaccuracy, remaining after laser trimming at the factory, can be adjusted to zero at any gain other than unity. To improve resolution and limit adjustment range, a resistor may be added in series with the wiper of the potentiometer and pin 12. This will, however, increase gain drift. Figure 5 shows the effect of gain adjustment. R_1 does not affect gain linearity.

OPTIONAL OFFSET ADJUSTMENT

Figure 4 also illustrates a technique for offset adjustment. This adjustment has no effect at unity gain. R_2 will trim the offset to zero and have negligible effect on the gain accuracy. For best results, trim the offset at the highest

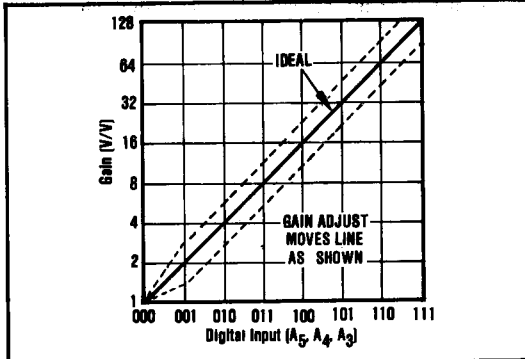

FIGURE 5. Effect of Gain Adjustment.

gain. If R_3 is made smaller, output offsetting can be accomplished. This can be used to introduce an intentional DC voltage at the output. The external amplifier used will add to the input noise, therefore, use one with a noise level of at least three times lower than that specified for the PGA100.

LAYOUT CONSIDERATIONS

Proper attention to layout is necessary to achieve the specified performance of the PGA100. Major goals are to reduce crosstalk, noise pickup, noise coupled from the power supply, and gain errors.

Be certain to separate analog and digital runs to avoid coupling of digital transients. To reduce gain errors, connect analog grounds with a ground plane or a low resistance star configuration as shown in Figure 3. Analog and digital commons must be connected at some point in the system to insure proper operation.

GAIN INACCURACY AND NONLINEARITY

As shown in Figure 3, connect pins 5 and 20 directly together at the unit and use pin 20 as the primary analog common. Ground resistance in series with pin 20 also appears in series with the internal gain-setting resistors and will decrease the magnitude of all gains except unity. The resulting accuracy error varies nonlinearly with the gain selected and therefore cannot be externally adjusted to zero for more than one gain at a time. Gain linearity is not affected by external ground resistance (see Performance Curves.)

CROSSTALK

Crosstalk is the amount of signal feedthrough from all OFF channels that appears at the output of the input multiplexer. It is expressed as a percent of the input signal applied to all OFF channels. For example, the 0.003% specification indicates that 0.6mV, p-p, out of a 20V, p-p, 1 kHz sine wave (applied to 7 OFF channels) will appear at the noninverting input of the internal op amp. Note that crosstalk increases with high frequencies due to the capacitive coupling between ON and OFF channels. It also increases with greater source resistance. However, because both the input signal and crosstalk noise are amplified equally, the resulting output signal-to-noise

ratio is independent of gain. Unused input channels should be grounded in order to reduce crosstalk and extraneous noise pickup. (See Performance Curves.)

SETTLING TIME

Settling time is the time required, after application of a step input signal, for the output voltage to settle and remain within a specified error band around the final value. It is a very important consideration since this will be the limiting parameter in determining the maximum channel scanning or throughput rate. The PGA100 specification includes the effects of both the multiplexer and amplifier. Note that settling time increases with increasing source resistance and gain. Minimum settling time is achieved by choosing a low source resistance, for example, $R_s \leq 10k\Omega$ and gains ≤ 16 . (See Performance Curves.)

INPUT OVERVOLTAGE PROTECTION

The PGA100 provides input overvoltage protection of 20V in excess of either power supply voltage expressed as $\pm(|V_{CC}| + 20)$. This is achieved in the dielectrically isolated analog multiplexer which will withstand overvoltage even when the power supplies are off. As a consequence the PGA100 is protected against high input levels and brief transient spikes of up to several hundred volts that can result from signals originating from outside the system. (See Performance Curves.)

TYPICAL APPLICATIONS

The PGA100 is ideal for a variety of applications, especially where low channel-to-channel crosstalk is required. In many applications the PGA100 will not require trimming of offset and gain errors. However, these can be minimized utilizing hardware or software error correction techniques. Figures 6 and 7 show

applications of the PGA100 separately and in a data acquisition system.

Figure 7 shows a Data Acquisition System. In this system the PGA100 allows the user to deal with signals of wide dynamic range while maintaining high system resolution. For example: When used with a 12-bit A/D converter in a "floating point" system, the 2^7 gain range of the PGA100 plus the 2^{12} range of the converter produces a total system resolution of 2^{19} (524,000 to 1).

Also the user can modify and reprogram gain values for different analog input channels merely by changing the software computer program. Since different dedicated amplifiers are not required for various input channels, the PGA100 also saves space and overall system costs. Software correction virtually eliminates system offset and gain errors over both time and temperature.

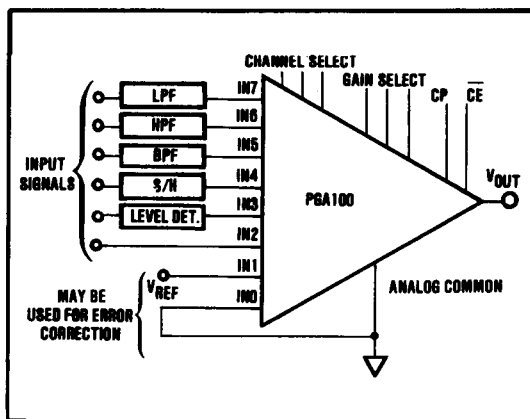

FIGURE 6. Digitally Selectable Function Amplifier.

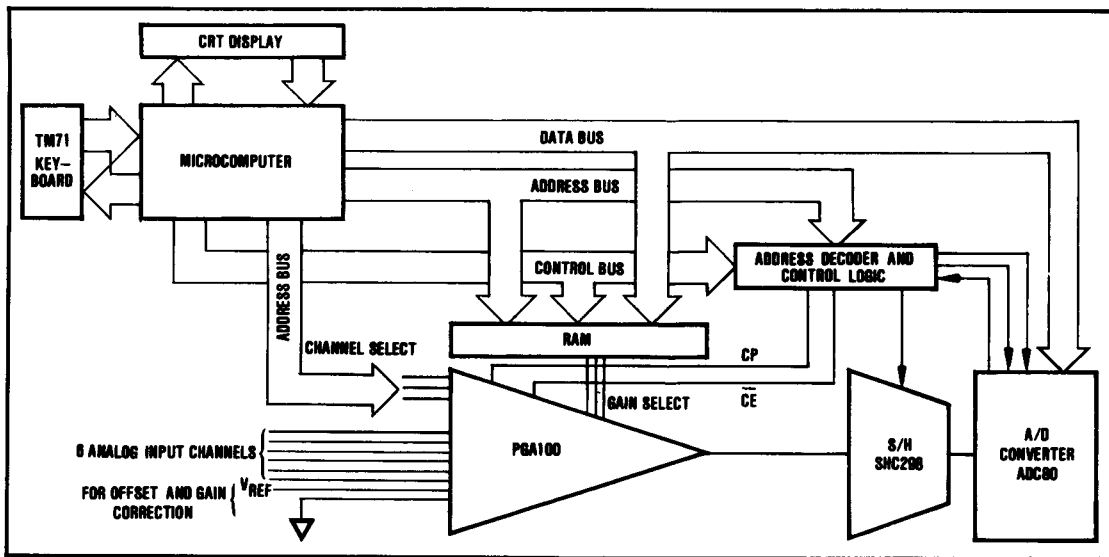

FIGURE 7. Use of PGA100 in a Data Acquisition System with Software Auto-zero and Gain Calibration.