

# THYRISTOR MODULE

# PGH1008AM

100A / 800V

OUTLINE DRAWING

## FEATURES

- \* Isolated Base
- \* 3 Phase Converter with Rush-Current Controllable Thyristor
- \* High Surge Capability
- \* UL Recognized, File No. E187184

## TYPICAL APPLICATIONS

- \* Converter For UPS , VVVF and Servo Motor Drive Amplifier

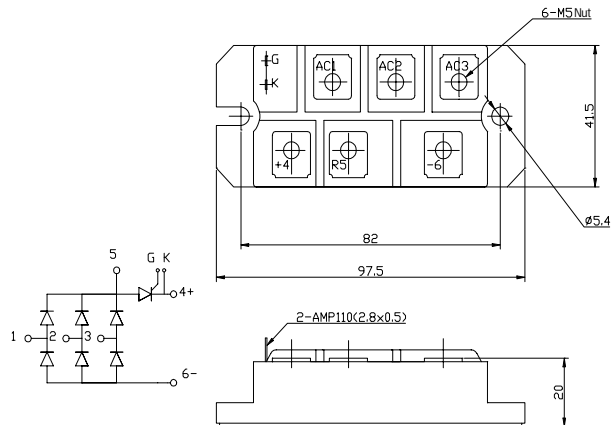

Approx Net Weight:200g

## Part of Diode Bridge and Thyristor Maximum Ratings

Parameter		Symbol	Conditions	Max Rated Value	Unit
Average Rectified Output Current		$I_{O(AV)}$	3 Phase Full Wave Rectified $T_c=98^\circ\text{C}(\text{Non-Bias})$ $T_c=73^\circ\text{C}(\text{Biased})$	100	A
Operating Junction Temperature Range		$T_{jw}$	$T_j > 125^\circ\text{C}$ , Can not be Biased for Thyristor.	-40 to +150	$^\circ\text{C}$
Storage Temperature Range		$T_{stg}$		-40 to +125	$^\circ\text{C}$
Isolation Voltage		Viso	Base Plate to Terminals, AC1min.	2000	V
Mounting torque	Case mounting	Ftor	Greased	2.4 to 2.8	N.m
	Terminals		M5 Screw		
			M5 Screw	2.4 to 2.8	

## Thermal Characteristics

Characteristics	Symbol	Test Conditions	Maximum Value.	Unit
Thermal Resistance	$R_{th(c-f)}$	Case to Fin, Total, Greased	0.06	$^\circ\text{C}/\text{W}$

## Part of Diode Bridge (6 dies)

### Maximum Ratings

Parameter	Symbol	Grade	Unit
		PGH1008AM	
Repetitive Peak Reverse Voltage *1	$V_{RRM}$	800	V
Non Repetitive Peak Reverse Voltage *1	$V_{RSM}$	900	

Parameter	Symbol	Conditions	Max Rated Value	Unit
Surge Forward Current *1	$I_{FSM}$	50 Hz Half Sine Wave, 1Pulse, Non-Repetitive	1200	A
I Squared t *1	$I^2t$	2msec to 10msec	7200	$\text{A}^2\text{s}$
Allowable Operating Frequency	f		400	Hz

\*1 Value Per 1 Arm

**Electrical • Thermal Characteristics**

Characteristics	Symbol	Test Conditions	Maximum Value.			Unit
			Min.	Typ.	Max.	
Peak Reverse Current *1	$I_{RM}$	$V_{RM}= V_{RRM}, T_j= 125^{\circ}C$			15	mA
Peak Forward Voltage *1	$V_{FM}$	$I_{FM}= 100A, T_j=25^{\circ}C$			1.16	V
Thermal Resistance	$R_{th(j-c)}$	Junction to Case (Total)			0.24	$^{\circ}C/W$

\*1 Value Per 1 Arm

**Part of Thyristor (1 die)**
**Maximum Ratings**

Parameter	Symbol	Grade		Unit
		PGH1008AM		
Repetitive Peak Off-State Voltage	$V_{DRM}$	800		V
Non Repetitive Peak Off-State Voltage	$V_{DSM}$	900		
Repetitive Peak Reverse Voltage	$V_{RRM}$	800		V
Non Repetitive Peak Reverse Voltage	$V_{RSM}$	900		

Parameter	Symbol	Conditions	Max Rated Value	Unit
Surge On-State Current	$I_{TSM}$	50 Hz Half Sine Wave, 1Pulse Non-Repetitive	2000	A
I Squared t	$I^2t$	2msec to 10msec	20000	$A^2s$
Critical Rate of Turned-On Current	$di/dt$	$V_D=2/3V_{DRM}, I_{TM}=2 \cdot I_O, T_j=125^{\circ}C$ $I_G=200mA, di_G/dt=0.2A/\mu s$	100	$A/\mu s$
Peak Gate Power	$P_{GM}$		5	W
Average Gate Power	$P_{G(AV)}$		1	W
Peak Gate Current	$I_{GM}$		2	A
Peak Gate Voltage	$V_{GM}$		10	V
Peak Gate Reverse Voltage	$V_{RGM}$		5	V

**Electrical • Thermal Characteristics**

Characteristics	Symbol	Test Conditions	Maximum Value.			Unit
			Min.	Typ.	Max.	
Peak Off-State Current	$I_{DM}$	$V_{DM}= V_{DRM}, T_j= 125^{\circ}C$			20	mA
Peak Reverse Current	$I_{RM}$	$V_{RM}= V_{RRM}, T_j= 125^{\circ}C$			20	mA
Peak On-State Voltage	$V_{TM}$	$I_{TM}= 100A, T_j=25^{\circ}C$			1.13	V
Gate Current to Trigger	$I_{GT}$	$V_D=6V, I_T=1A$	$T_j=-40^{\circ}C$		200	mA
			$T_j=25^{\circ}C$		100	
			$T_j=125^{\circ}C$		50	
Gate Voltage to Trigger	$V_{GT}$	$V_D=6V, I_T=1A$	$T_j=-40^{\circ}C$		4	V
			$T_j=25^{\circ}C$		2.5	
			$T_j=125^{\circ}C$		2	
Gate Non-Trigger Voltage	$V_{GD}$	$V_D=2/3V_{DRM}, T_j=125^{\circ}C$	0.25			V
Critical Rate of Rise of Off-State Voltage	$dv/dt$	$V_D=2/3V_{DRM}, T_j=125^{\circ}C$	500			$V/\mu s$
Turn-Off Time	$t_q$	$I_{TM}=I_O, V_D=2/3V_{DRM}$ $dv/dt=20V/\mu s, V_R=100V$ $-di/dt=20A/\mu s, T_j=125^{\circ}C$		150		$\mu s$
Turn-On Time	$t_{gt}$	$V_D=2/3V_{DRM}, T_j=125^{\circ}C$ $I_G=200mA, di_G/dt=0.2A/\mu s$		6		$\mu s$
Delay Time	$t_d$			2		$\mu s$
Rise Time	$t_r$			4		$\mu s$
Latching Current	$I_L$	$T_j=25^{\circ}C$		100		mA
Holding Current	$I_H$	$T_j=25^{\circ}C$		80		
Thermal Resistance	$R_{th(j-c)}$	Junction to Case			0.5	$^{\circ}C/W$

PGH1008AM OUTLINE DRAWING (Dimensions in mm)

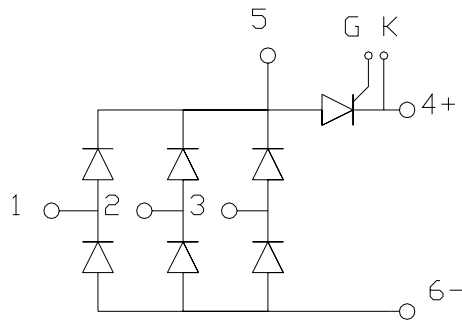
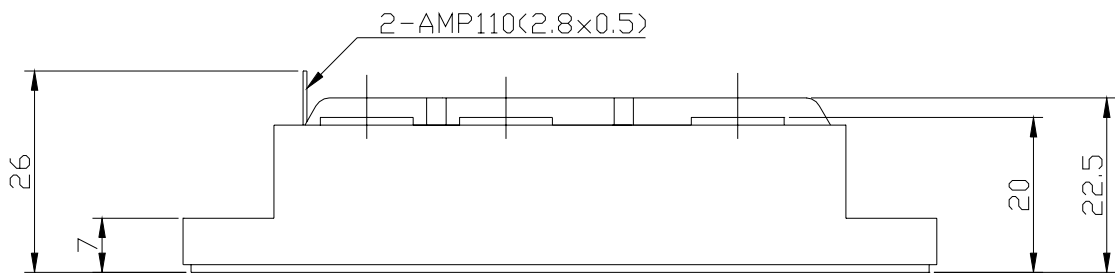
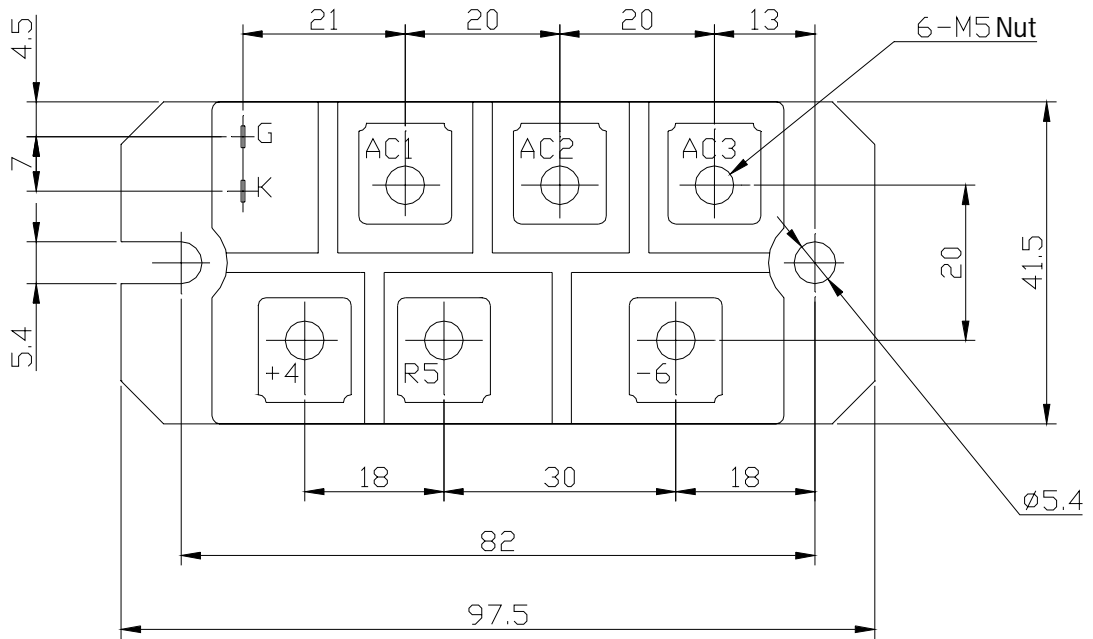

順電圧特性  
FORWARD CURRENT VS. VOLTAGE

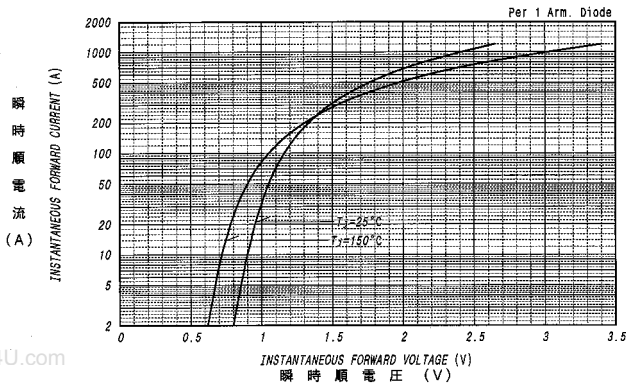

平均順電力損失特性  
AVERAGE FORWARD POWER DISSIPATION

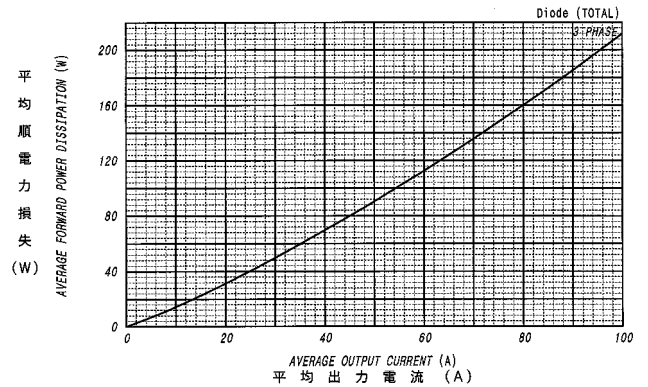

オン電圧特性  
ON-STATE CURRENT VS. VOLTAGE

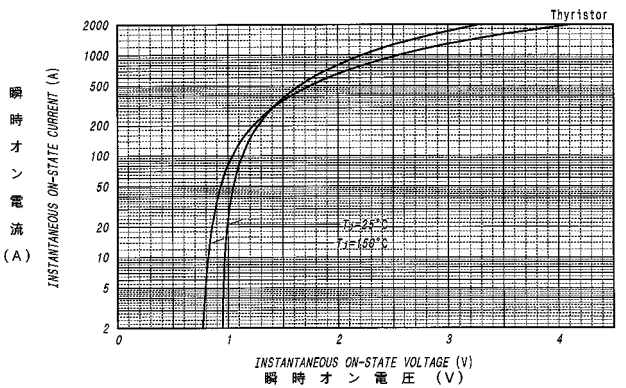

平均オン電力損失特性  
AVERAGE ON-STATE POWER DISSIPATION

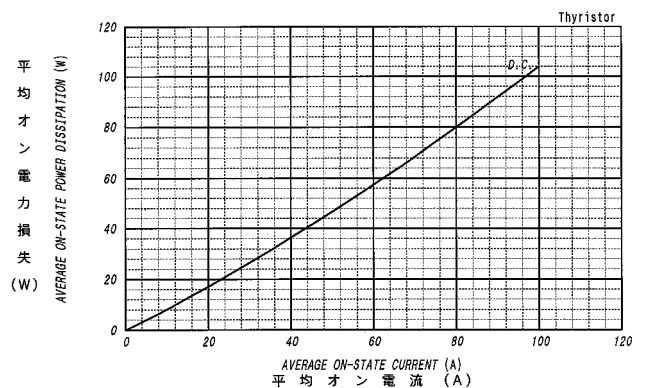

平均出力電流 - ケース温度定格  
AVERAGE OUTPUT CURRENT VS. CASE TEMPERATURE  
3-Phase Full Wave, Resistive or Inductive Load

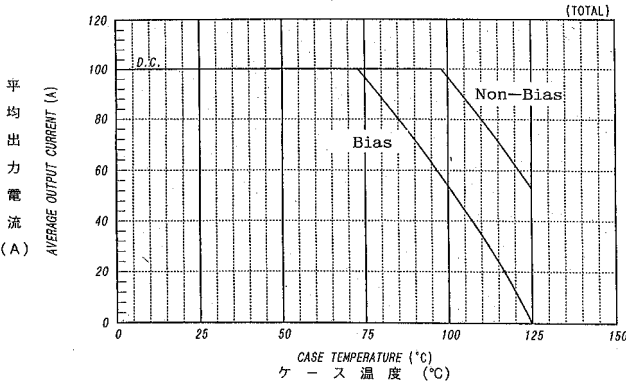

サージ電流定格  
SURGE CURRENT RATINGS

f=50Hz, Half Sine Wave, Non-Repetitive, On Load

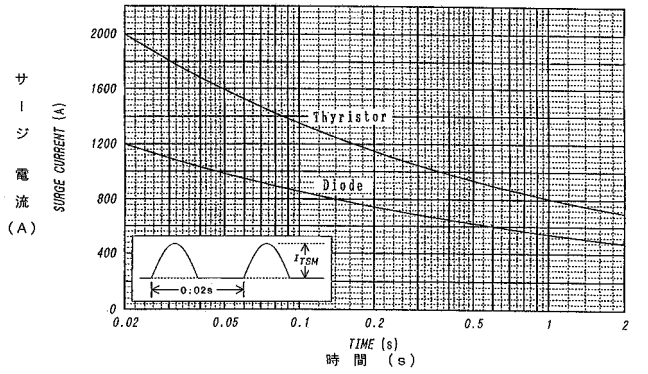

ゲート特性  
GATE CHARACTERISTICS

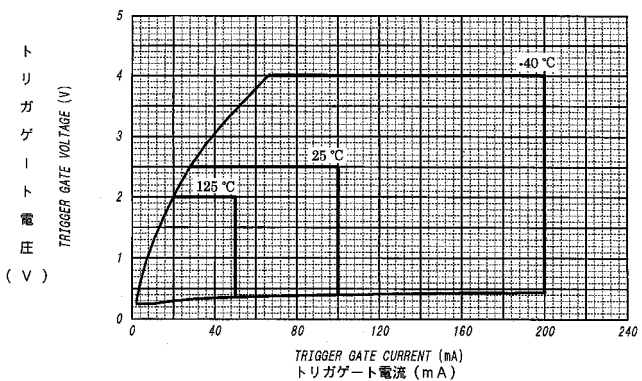

ゲート定格  
GATE RATINGS

