

THYRISTOR MODULE

PGH758AM

75A / 800V

OUTLINE DRAWING

FEATURES

- * Isolated Base
- * 3 Phase Converter with Rush-Current Controllable Thyristor
- * High Surge Capability
- * UL Recognized, File No. E187184

TYPICAL APPLICATIONS

- * Converter For UPS , VVVF and Servo Motor Drive Amplifier

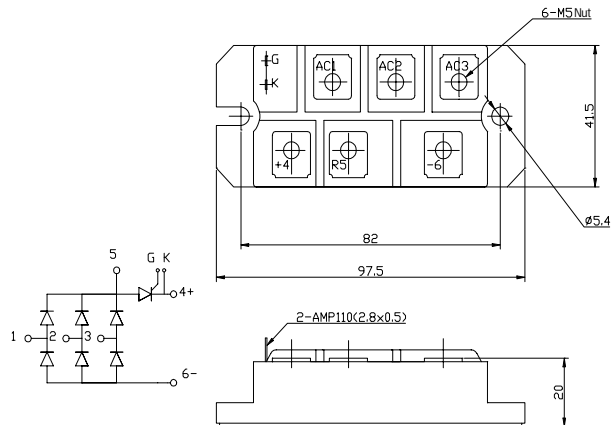

Approx Net Weight:200g

Part of Diode Bridge and Thyristor Maximum Ratings

Parameter		Symbol	Conditions	Max Rated Value	Unit
Average Rectified Output Current		$I_{O(AV)}$	3 Phase Full Wave Rectified Tc=101°C(Non-Bias) Tc=76°C(Biased)	75	A
Operating Junction Temperature Range		Tjw	Tj>125°C, Can not be Biased for Thyristor.	-40 to +150	°C
Storage Temperature Range		Tstg		-40 to +125	°C
Isolation Voltage		Viso	Base Plate to Terminals, AC1min.	2000	V
Mounting torque	Case mounting	Ftor	Greased	2.4 to 2.8	N.m
	Terminals		M5 Screw	2.4 to 2.8	

Thermal Characteristics

Characteristics	Symbol	Test Conditions	Maximum Value.	Unit
Thermal Resistance	Rth(c-f)	Case to Fin,Total,Greased	0.06	°C/W

Part of Diode Bridge (6 dies)

Maximum Ratings

Parameter	Symbol	Grade	Unit
		PGH758AM	
Repetitive Peak Reverse Voltage *1	V_{RRM}	800	V
Non Repetitive Peak Reverse Voltage *1	V_{RSM}	900	

Parameter	Symbol	Conditions	Max Rated Value	Unit
Surge Forward Current *1	I_{FSM}	50 Hz Half Sine Wave,1Pulse, Non-Repetitive	1000	A
I Squared t *1	I^2t	2msec to 10msec	5000	A ² s
Allowable Operating Frequency	f		400	Hz

*1 Value Per 1 Arm

Electrical • Thermal Characteristics

Characteristics	Symbol	Test Conditions	Maximum Value.			Unit
			Min.	Typ.	Max.	
Peak Reverse Current *1	I_{RM}	$V_{RM}= V_{RRM}, T_j= 125^{\circ}C$			10	mA
Peak Forward Voltage *1	V_{FM}	$I_{FM}= 75A, T_j=25^{\circ}C$			1.20	V
Thermal Resistance	$R_{th(j-c)}$	Junction to Case (Total)			0.24	$^{\circ}C/W$

*1 Value Per 1 Arm

Part of Thyristor (1 die)
Maximum Ratings

Parameter	Symbol	Grade		Unit
		PGH758AM		
Repetitive Peak Off-State Voltage	V_{DRM}	800		V
Non Repetitive Peak Off-State Voltage	V_{DSM}	900		
Repetitive Peak Reverse Voltage	V_{RRM}	800		V
Non Repetitive Peak Reverse Voltage	V_{RSM}	900		

Parameter	Symbol	Conditions	Max Rated Value	Unit
I Squared t	I^2t	2msec to 10msec	5000	A^2s
Critical Rate of Turned-On Current	di/dt	$V_D=2/3V_{DRM}, I_{TM}=2 \cdot I_O, T_j=125^{\circ}C$ $I_G=200mA, di_G/dt=0.2A/\mu s$	100	$A/\mu s$
Peak Gate Power	P_{GM}		5	W
Average Gate Power	$P_{G(AV)}$		1	W
Peak Gate Current	I_{GM}		2	A
Peak Gate Voltage	V_{GM}		10	V
Peak Gate Reverse Voltage	V_{RGM}		5	V

Electrical • Thermal Characteristics

Characteristics	Symbol	Test Conditions	Maximum Value.			Unit
			Min.	Typ.	Max.	
Peak Off-State Current	I_{DM}	$V_{DM}= V_{DRM}, T_j= 125^{\circ}C$			15	mA
Peak Reverse Current	I_{RM}	$V_{RM}= V_{RRM}, T_j= 125^{\circ}C$			15	mA
Peak On-State Voltage	V_{TM}	$I_{TM}= 75A, T_j=25^{\circ}C$			1.17	V
Gate Current to Trigger	I_{GT}	$V_D=6V, I_T=1A$	$T_j=-40^{\circ}C$		200	mA
			$T_j=25^{\circ}C$		100	
			$T_j=125^{\circ}C$		50	
Gate Voltage to Trigger	V_{GT}	$V_D=6V, I_T=1A$	$T_j=-40^{\circ}C$		4	V
			$T_j=25^{\circ}C$		2.5	
			$T_j=125^{\circ}C$		2	
Gate Non-Trigger Voltage	V_{GD}	$V_D=2/3V_{DRM}, T_j=125^{\circ}C$	0.25			V
Critical Rate of Rise of Off-State Voltage	dv/dt	$V_D=2/3V_{DRM}, T_j=125^{\circ}C$	500			$V/\mu s$
Turn-Off Time	t_q	$I_{TM}=I_O, V_D=2/3V_{DRM}$ $dv/dt=20V/\mu s, V_R=100V$ $-di/dt=20A/\mu s, T_j=125^{\circ}C$		150		μs
Turn-On Time	t_{gt}	$V_D=2/3V_{DRM}, T_j=125^{\circ}C$ $I_G=200mA, di_G/dt=0.2A/\mu s$		6		μs
Delay Time	t_d			2		μs
Rise Time	t_r			4		μs
Latching Current	I_L	$T_j=25^{\circ}C$		100		mA
Holding Current	I_H	$T_j=25^{\circ}C$		80		
Thermal Resistance	$R_{th(j-c)}$	Junction to Case			0.6	$^{\circ}C/W$

PGH758AM OUTLINE DRAWING (Dimensions in mm)

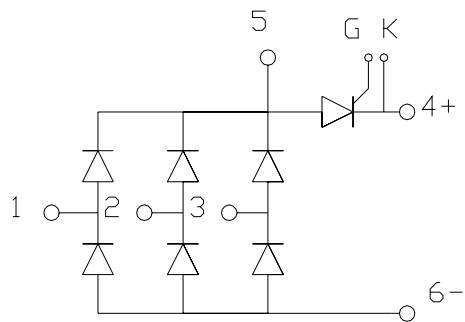
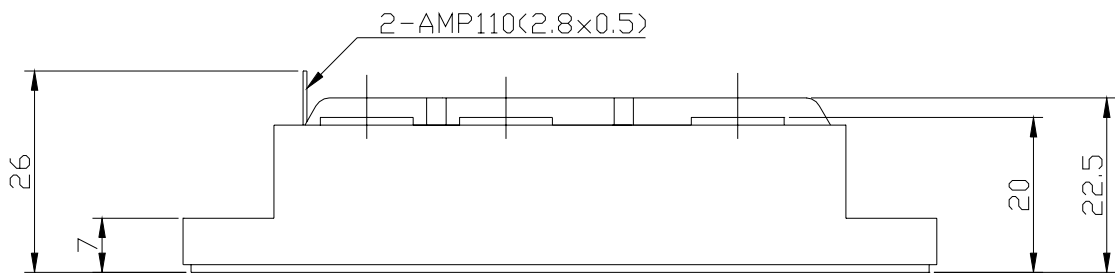
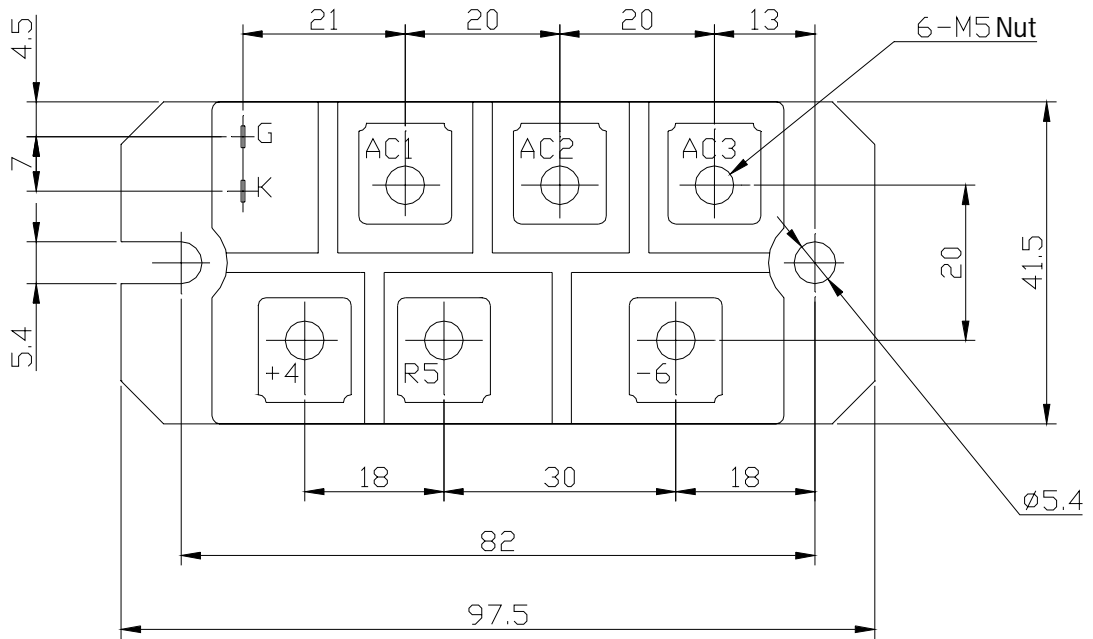

順電圧特性
FORWARD CURRENT VS. VOLTAGE

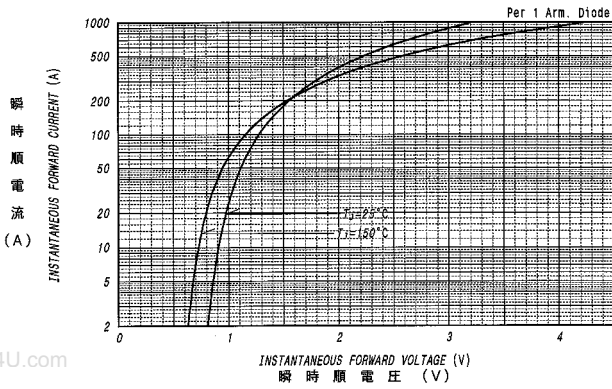

平均順電力損失特性
AVERAGE FORWARD POWER DISSIPATION

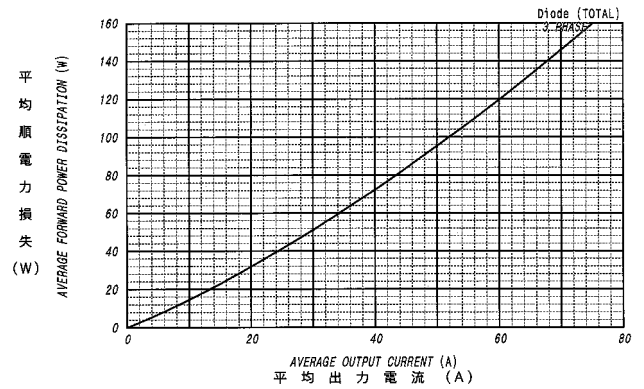

オン電圧特性
ON-STATE CURRENT VS. VOLTAGE

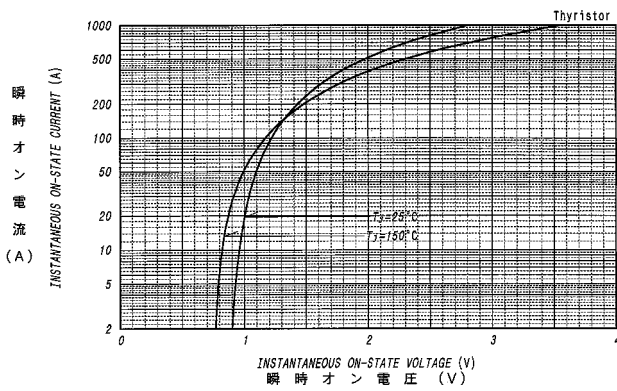

平均オン電力損失特性
AVERAGE ON-STATE POWER DISSIPATION

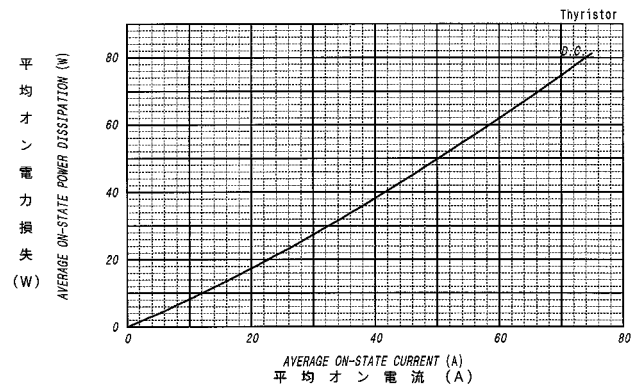

平均出力電流 - ケース温度定格
AVERAGE OUTPUT CURRENT VS. CASE TEMPERATURE

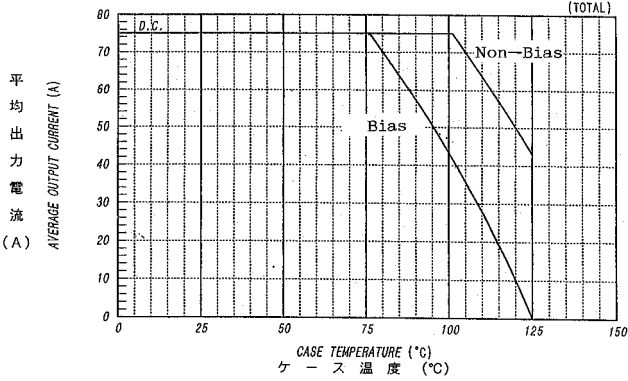

サージ電流定格
SURGE CURRENT RATINGS

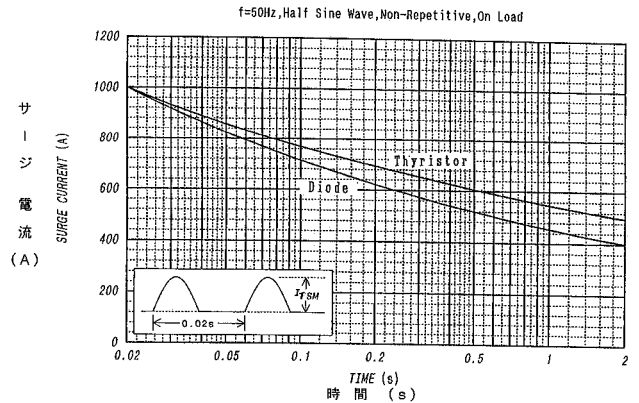

ゲート特性
GATE CHARACTERISTICS

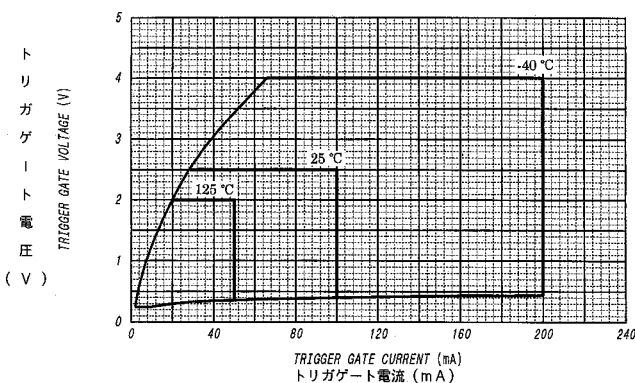

ゲート定格
GATE RATINGS

