

SPECIFICATIONS

CUSTOMER	:	PTC
SAMPLE CODE	:	SH240320T-062-L06Q
MASS PRODUCTION CODE	:	PH240320T-062-L06Q
SAMPLE VERSION	:	01
SPECIFICATIONS EDITION	:	005
DRAWING NO.	:	JLMD- PH240320T-062-L06Q_001
PACKAGING NO.	:	JPKG- PH240320T-062-L06Q_001

Customer Approved

Date:

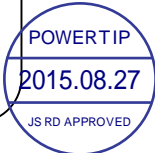

Approved	Checked	Designer
閔偉	劉進	張斌

- Preliminary specification for design input
- Specification for sample approval

POWERTIP TECH. CORP.

Headquarters:
 No.8, 6th Road, Taichung Industrial Park,
 Taichung, Taiwan
 台中市 407 工業區六路 8 號

TEL: 886-4-2355-8168
 FAX: 886-4-2355-8166

E-mail: sales@powertip.com.tw
[Http://www.powertip.com.tw](http://www.powertip.com.tw)

Contents

1. SPECIFICATIONS

- 1.1 Features
- 1.2 Mechanical Specifications
- 1.3 Absolute Maximum Ratings
- 1.4 DC Electrical Characteristics
- 1.5 Optical Characteristics
- 1.6 Backlight Characteristics
- 1.7 Touch Panel Characteristics

2. MODULE STRUCTURE

- 2.1 Counter Drawing
- 2.2 Interface Pin Description
- 2.3 Timing Characteristics

3. QUALITY ASSURANCE SYSTEM

- 3.1 Quality Assurance Flow Chart
- 3.2 Inspection Specification

4. RELIABILITY TEST

- 4.1 Reliability Test Condition

5. PRECAUTION RELATING PRODUCT HANDLING

- 5.1 Safety
- 5.2 Handling
- 5.3 Storage
- 5.4 Terms of Warranty

- Appendix : 1. LCM Drawing
2. Packaging

1. SPECIFICATIONS

1.1 Features

Main LCD Panel

Item	Standard Value
Display Type	240 * (R、G、B) * 320 Dots
LCD Type	a-Si TFT , Normally white TN mode , Transmissive
Screen size(inch)	2.4 (Diagonal)
Viewing Direction	12 O'clock
Color configuration	R.G.B. vertical stripe
Interface	16-bit interface for i80system
Other(controller / driver IC)	ILI9341
ROHS	THIS PRODUCT CONFORMS THE ROHS OF PTC Detail information please refer web side : http://www.powertip.com.tw/news.php?area_id_view=1085560481/

1.2 Mechanical Specifications

Item	Standard Value	Unit
Outline Dimension	42.72 (W) * 60.26 (L) * 3.85(H)(max)	mm

LCD Panel

Item	Standard Value	Unit
Active Area	36.72 (W) * 48.96 (L)	mm

TP Panel

Item	Standard Value	Unit
Viewing Area	38.32 (W)* 50.26 (L)(min)	mm
Active Area	37.52 (W) * 49.76 (L)	mm

Note : For detailed information please refer to LCM drawing

1.3 Absolute Maximum Ratings

Module

Item	Symbol	Condition	Min.	Max.	Unit
System Power Supply Voltage	VDDI	-	-0.3	+4.6	V
	VGH-VGL	-	-0.3	+32.0	V
Input Voltage	VIN	-	-0.3	VDD+0.3	V
Operating Temperature	T _{OP}	-	-20	+70	°C
Storage Temperature	T _{ST}	-	-30	+80	°C
Storage Humidity	H _D	T _a ≅ 60 °C	20	90	%RH

1.4 DC Electrical Characteristics

Module

GND = 0V, T_a = 25°C

Item	Symbol	Condition	Min.	Typ.	Max.	Unit
Power Supply Voltage ¹	VDDI	-	2.5	2.8	3.3	V
Input High Voltage	V _{IH}	-	0.7*VDDI	-	VDDI	V
Input Low Voltage	V _{IL}	-	VSS	-	0.3*VDDI	V
Output High Voltage	V _{OH}	I _{OH} =-1.0 mA	0.8*VDDI	-	VDDI	V
Output Low Voltage	V _{OL}	I _{OL} =+1.0mA	VSS	-	0.2*VDDI	V
Supply Current	I _{DD}	VDDI= 2.8V, Pattern=Black*1	-	7.7	12	mA

Note1 : Maximum current display

1.5 Optical Characteristics

TFT LCD Panel

VDDI = 2.8V, Ta=25°C

Item	Symbol	Condition	Min.	Typ.	Max.	unit		
Response time	Tr + Tf	Ta = 25°C θX, θY = 0°	-	25	38	ms	Note2	
Viewing angle	Top	θY+	CR ≥ 10	-	45	-	Deg.	Note4
	Bottom	θY-		-	15	-		
	Left	θX-		-	45	-		
	Right	θX+		-	45	-		
Contrast ratio	CR		150	200	-	-	Note3	
Color of CIE Coordinate (With B/L)	White	X	Ta = 25°C θX, θY = 0°	0.23	0.28	0.33	-	Note1
		Y		0.25	0.30	0.35		
	Red	X		0.53	0.58	0.63		
		Y		0.29	0.34	0.39		
	Green	X		0.27	0.32	0.37		
		Y		0.54	0.59	0.64		
	Blue	X		0.09	0.14	0.19		
		Y		0.01	0.06	0.11		
Average Brightness Pattern=white display (With B/L)	IV	IF=20mA	140	155	-	cd/m ²	Note1	
Uniformity (With B/L)	ΔB	IF=20mA	80	-	-	%	Note1	

Note1:

1 : $\Delta B = B(\min) / B(\max) \times 100\%$

2 : Measurement Condition for Optical Characteristics:

- a : Environment: 25°C±5°C / 60±20%R.H , no wind , dark room below 10 Lux at typical lamp current and typical operating frequency.
- b : Measurement Distance: 500 ± 50 mm , (θ= 0°)
- c : Equipment: TOPCON BM-7 fast , (field 1°) , after 10 minutes operation.
- d : The uncertainty of the C.I.E coordinate measurement ±0.01 , Average Brightness ± 4%

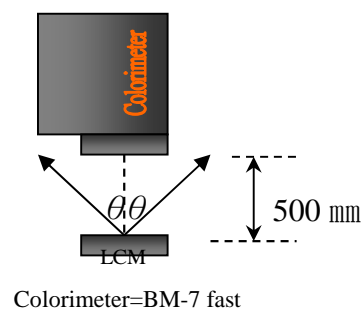

Note2: Definition of response time:

The output signals of photo detector are measured when the input signals are changed from “black” to “white”(falling time) and from “white” to “black”(rising time), respectively. The response time is defined as the time interval between the 10% and 90% of Amplitudes.

Refer to figure as below:

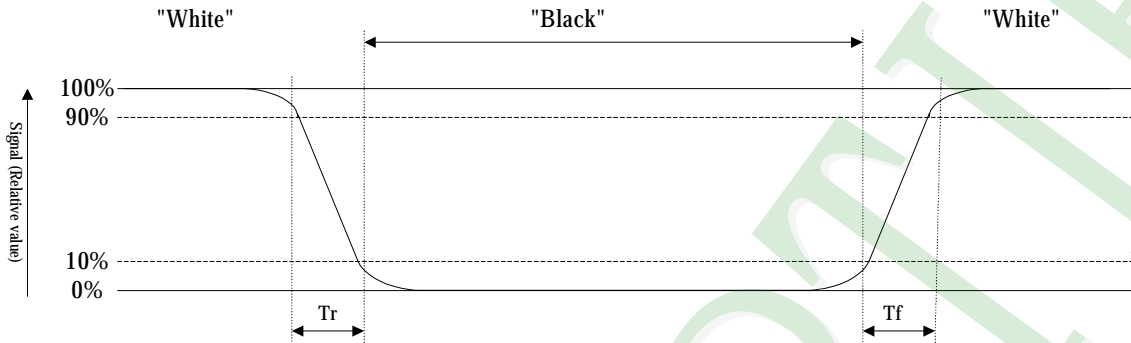

Note3: Definition of contrast ratio:

Contrast ratio is calculated with the following formula

$$\text{Contrast ratio (CR)} = \frac{\text{Photo detector output when LCD is at "White" state}}{\text{Photo detector output when LCD is at "Black" state}}$$

Note4: Definition of viewing angle:

Refer to figure as below:

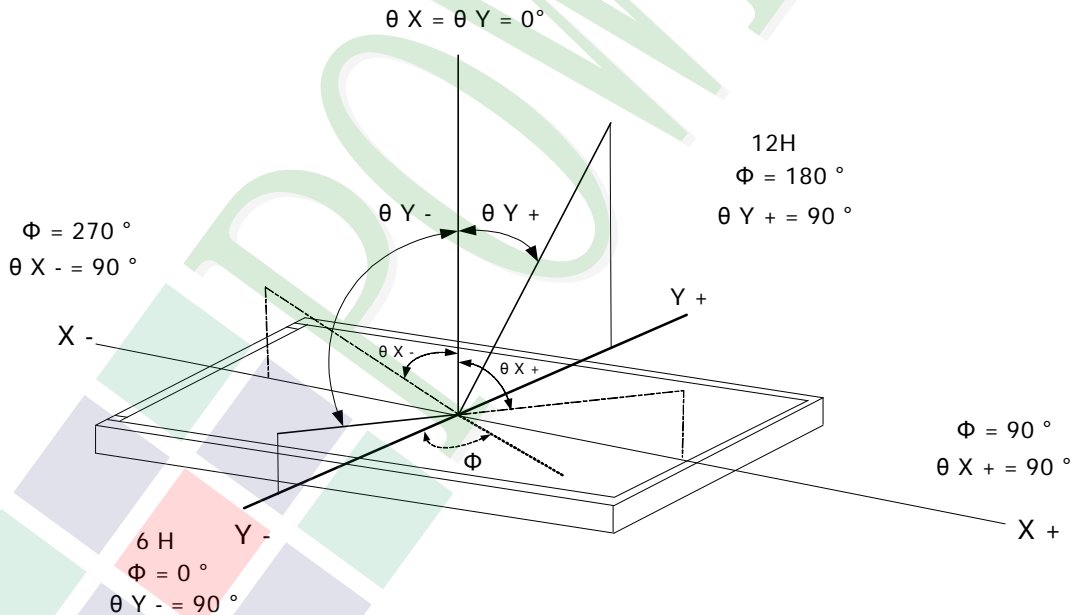

1.6 Backlight Characteristics

Maximum Ratings

Item	Symbol	Conditions	Min.	Max.	Unit
Forward Current	IF	Ta =25°C	-	30	mA
Forward Voltage	VF	Ta =25°C	-	14.4	V
Reverse Voltage	VR	Ta =25°C	-	5	V

Electrical / Optical Characteristics

Item	Symbol	Conditions	Min.	Typ.	Max.	Unit
Forward Voltage	VF	IF=20mA	12.4	13.2	14.4	V
Average Brightness (without LCD & T/P)	IV	IF=20mA	3800	4200	-	cd/m ²
Color of CIE Coordinate (without LCD & T/P)	X		0.25	0.28	0.31	-
	Y		0.25	0.28	0.31	
Color	White					

Internal Circuit Diagram

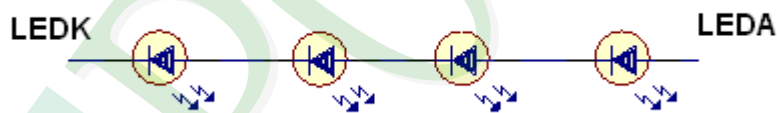

Other Description

Item	Conditions	Description
Life Time	Ta =25°C IF= 20mA	20000 hrs

1.7 Touch Panel Characteristics

1.7.1 General Standard Specification

Item	Specification
Input Method	Finger or Stylus pen.
ITO Glass	400±100 Ω Glass.
ITO Film	470±100 Ω Clear Hard-Coating
Operating Temperature Range	-10°C~60°C,20~85%RH. (Except for dew gathering)
Storage Temperature Range	-20°C~70°C, 10%RH ~ 90%RH.(Except for dew gathering)
Surface Hardness	3H pencil pressure 1N/45
Hitting Durability	1,000,000 times (R8,hardness 60°,120gf)
Pen Sliding Durability	100,000 times (R0.8mm,with 120gf)
Insulation Impedance	≥ 20MΩ/25V(DC)
Light Transparency	≥ 80%-550nm
Linearity	≤ 1.5%
Linearity Force	10g~80g input with stylus pen. (R0.8mm)
Activation Force	50gf(Typical 20gf)less individual point on with stylus pen 9R0.8mm
Bouncing	≤10ms.
Impact Resistance	No damage when φ9mm steel ball is dropped on the surface from 30 cm height at 1 time.
Flexible pattern Heat Seal Peeling Strength	500gf/cm (peeling upward by 90deg)
Flexible pattern Bending Resistance	Bending 3 times by bending radius R1.0 mm The requirements in4-2shall be satisfied
Flexible Pattern Insert/Pull Out Resistance	5times at least .The requirements in 4-2shall be satisfied.
Vibration Resistance	Not in operation :The requirements in 3 to 4 shall be satisfied after sweep vibration of 2G15~55Hz(1min) is given for 30 min ,each in the directions of X,Y,Z.
Package Drop	No damage to the product.(1 corner edge,2ridges,4 surfaces ,drop from 50 cm height).
Static load resistance	<p>After 4.5Kg load for 1 min is Applied to the center area (25c m²)of the Touch panel ,the requirements in 3 and 4,shall be satisfied.</p> 

1.7.2 Electrical Characteristics

Item	Specification
Operating Voltage	DC 5V. (Max : 7V DC)
Bouncing	$\leq 10\text{ms}$
Insulation Resistance	$\geq 20\text{M}\Omega/25\text{V}(\text{DC})$
Resistance Between Terminals	Direction X : $200\Omega \sim 600\Omega$.
	Direction Y : $250\Omega \sim 900\Omega$.
Linearity	$X \leq 1.5\%$, $Y \leq 1.5\%$

2. MODULE STRUCTURE

2.1 Counter Drawing

2.1.1 LCM Mechanical Diagram

* See Appendix

2.1.2 Block Diagram

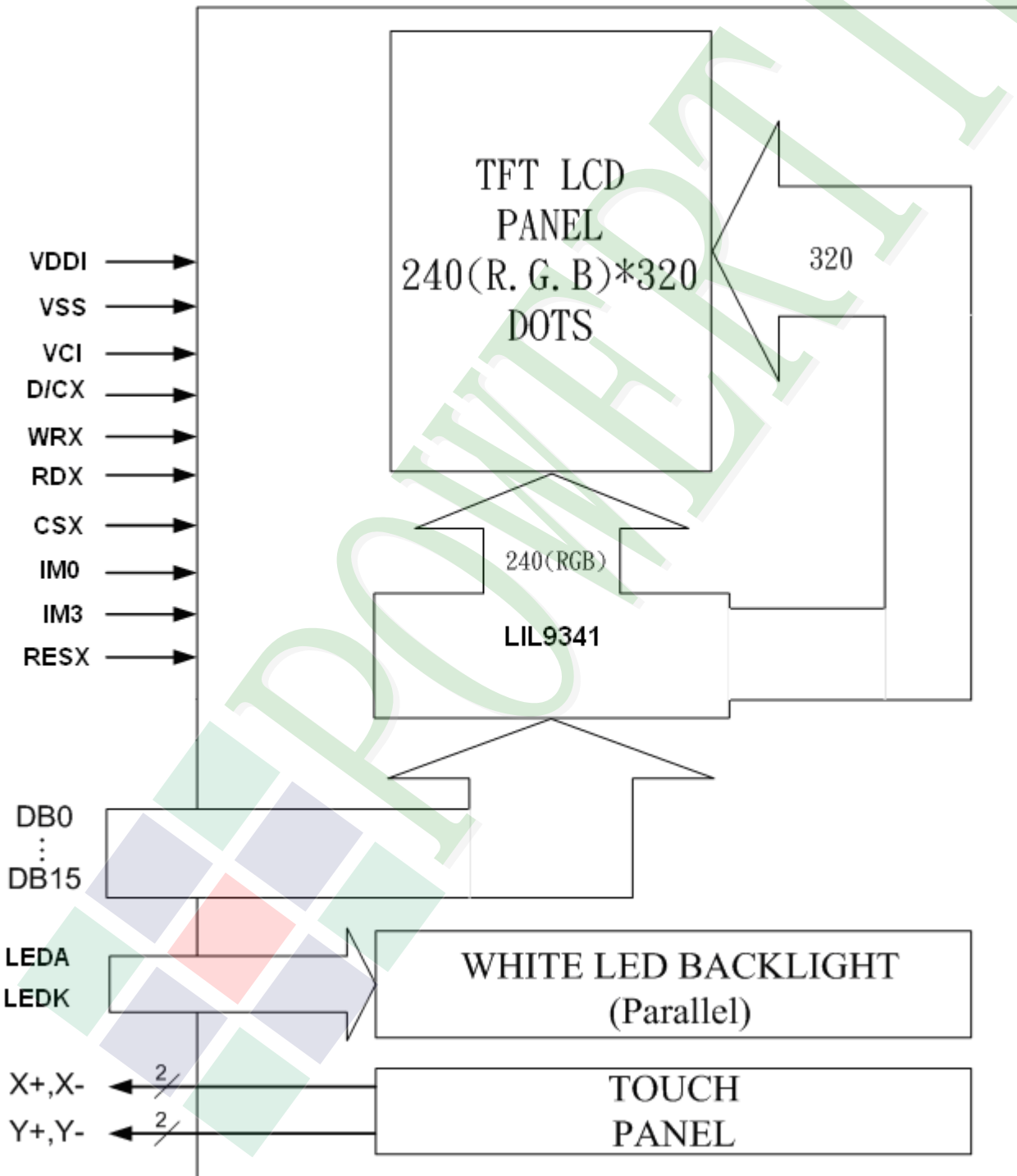

2.2 Interface Pin Description

Pin No.	Symbol	Function
1	DB0	Bi-directional data bus.
2	DB1	Bi-directional data bus.
3	DB2	Bi-directional data bus.
4	DB3	Bi-directional data bus.
5	VSS	System ground.(0V)
6	VDDI	Low voltage power supply for interface logic circuits (1.65 ~ 3.3 V)
7	CSX	Chip select signal , Active "L".
8	D/CX	Command / Display data selection. 0 : Command , 1 : Display data.
9	WRX	8080- I system (WRX): Serves as a write signal and writes data at the rising edge.
10	RDX	8080- I system (RDX): Serves as a read signal and MCU read data at the rising edge.
11	IM0	IM3=0,IM2=0,IM1=0,IM0=1,80 MCU 16-bit bus interface I , D[15:0]
12	X+	Touch Panel control pin.
13	Y+	Touch Panel control pin.
14	X-	Touch Panel control pin.
15	Y-	Touch Panel control pin.
16	LEDA	Power supply for LED Backlight Anode input.
17	LEDk	Power supply for LED Backlight Cathode input.
18	NC	
19	NC	NC
20	NC	
21	IM3	IM3=0,IM2=0IM1=0,IM0=1,80 MCU 16-bit bus interface I , D[15:0]
22	DB4	Bi-directional data bus.
23	DB8	Bi-directional data bus.
24	DB9	Bi-directional data bus.
25	DB10	Bi-directional data bus.

26	DB11	Bi-directional data bus.
27	DB12	Bi-directional data bus.
28	DB13	Bi-directional data bus.
29	DB14	Bi-directional data bus.
30	DB15	Bi-directional data bus.
31	RESX	This signal will reset the device and must be applied to properly initialize the chip. Signal is active low.
32	VCI	High voltage power supply for analog circuit blocks (2.5 ~ 3.3 V)
33	VDDI	Low voltage power supply for interface logic circuits (1.65 ~ 3.3 V)
34	VSS	System ground.(0V)
35	DB5	Bi-directional data bus.
36	DB6	Bi-directional data bus.
37	DB7	Bi-directional data bus.

2.2.1 Refer Initial Code

```
void Initial_Main(void)                // For ILI9341
{
    WriteCOM_Main(0x00,0xCF);
    WriteDAT_Main(0x00,0x00);
    WriteDAT_Main(0x00,0xD9);
    WriteDAT_Main(0x00,0x30);

    WriteCOM_Main(0x00,0xED);
    WriteDAT_Main(0x00,0x64);
    WriteDAT_Main(0x00,0x03);
    WriteDAT_Main(0x00,0x12);
    WriteDAT_Main(0x00,0x81);

    WriteCOM_Main(0x00,0xE8);
    WriteDAT_Main(0x00,0x85);
    WriteDAT_Main(0x00,0x00);
    WriteDAT_Main(0x00,0x78);

    WriteCOM_Main(0x00,0xCB);
    WriteDAT_Main(0x00,0x39);
    WriteDAT_Main(0x00,0x2C);
    WriteDAT_Main(0x00,0x00);
    WriteDAT_Main(0x00,0x34);
    WriteDAT_Main(0x00,0x02);

    WriteCOM_Main(0x00,0xF7);
    WriteDAT_Main(0x00,0x20);

    WriteCOM_Main(0x00,0xEA);
    WriteDAT_Main(0x00,0x00);
    WriteDAT_Main(0x00,0x00);

    WriteCOM_Main(0x00,0xC0);
    WriteDAT_Main(0x00,0x21);

    WriteCOM_Main(0x00,0xC1);
    WriteDAT_Main(0x00,0x12);
```

```
WriteCOM_Main(0x00,0xC5);  
WriteDAT_Main(0x00,0x32);  
WriteDAT_Main(0x00,0x3C);
```

```
WriteCOM_Main(0x00,0xC7);  
WriteDAT_Main(0x00,0xa3);
```

```
WriteCOM_Main(0x00,0x36);  
WriteDAT_Main(0x00,0x08);
```

```
WriteCOM_Main(0x00,0x3A);  
WriteDAT_Main(0x00,0x55);
```

```
WriteCOM_Main(0x00,0xB1);  
WriteDAT_Main(0x00,0x00);  
WriteDAT_Main(0x00,0x1B);
```

```
WriteCOM_Main(0x00,0xB6);  
WriteDAT_Main(0x00,0x0a);  
WriteDAT_Main(0x00,0xa2);
```

```
WriteCOM_Main(0x00,0xF6);  
WriteDAT_Main(0x00,0x01);  
WriteDAT_Main(0x00,0x30);
```

```
WriteCOM_Main(0x00,0xF2);  
WriteDAT_Main(0x00,0x00);
```

```
WriteCOM_Main(0x00,0x26);  
WriteDAT_Main(0x00,0x01);
```

```
WriteCOM_Main(0x00,0xe0); //set gamma  
WriteDAT_Main(0x00,0x0f);  
WriteDAT_Main(0x00,0x1c);  
WriteDAT_Main(0x00,0x19);  
WriteDAT_Main(0x00,0x08);  
WriteDAT_Main(0x00,0x0b);  
WriteDAT_Main(0x00,0x04);
```

```
WriteDAT_Main(0x00,0x4b);  
WriteDAT_Main(0x00,0x64);  
WriteDAT_Main(0x00,0x3e);  
WriteDAT_Main(0x00,0x09);  
WriteDAT_Main(0x00,0x15);  
WriteDAT_Main(0x00,0x08);  
WriteDAT_Main(0x00,0x16);  
WriteDAT_Main(0x00,0x0D);  
WriteDAT_Main(0x00,0x04);
```

```
WriteCOM_Main(0x00,0xe1); //set gamma  
WriteDAT_Main(0x00,0x00);  
WriteDAT_Main(0x00,0x1a);  
WriteDAT_Main(0x00,0x1e);  
WriteDAT_Main(0x00,0x03);  
WriteDAT_Main(0x00,0x0f);  
WriteDAT_Main(0x00,0x03);  
WriteDAT_Main(0x00,0x35);  
WriteDAT_Main(0x00,0x23);  
WriteDAT_Main(0x00,0x45);  
WriteDAT_Main(0x00,0x04);  
WriteDAT_Main(0x00,0x0c);  
WriteDAT_Main(0x00,0x0b);  
WriteDAT_Main(0x00,0x2b);  
WriteDAT_Main(0x00,0x2e);  
WriteDAT_Main(0x00,0x05);
```

```
WriteCOM_Main(0x00,0x11);
```

```
Delay(120);
```

```
WriteCOM_Main(0x00,0x29);
```

```
}
```

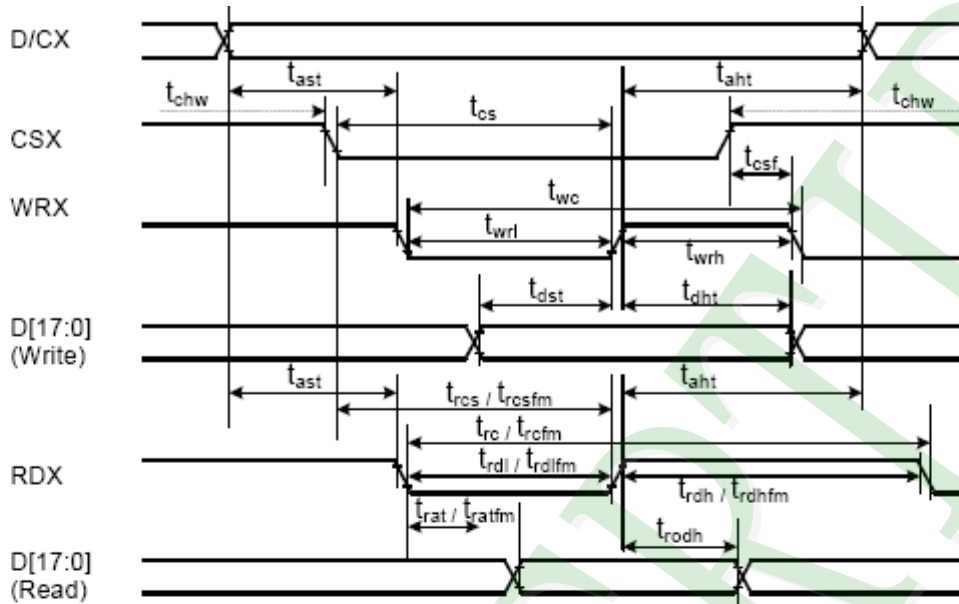

2.3 Timing Characteristics

80-System Bus Interface I

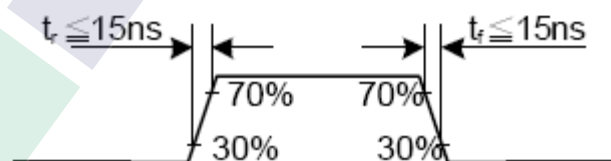

Signal	Symbol	Parameter	min	max	Unit	Description
DCX	t _{ast}	Address setup time	0	-	ns	
	t _{ah}	Address hold time (Write/Read)	0	-	ns	
CSX	t _{chw}	CSX "H" pulse width	0	-	ns	
	t _{cs}	Chip Select setup time (Write)	15	-	ns	
	t _{rcs}	Chip Select setup time (Read ID)	45	-	ns	
	t _{rcsfm}	Chip Select setup time (Read FM)	355	-	ns	
	t _{csf}	Chip Select Wait time (Write/Read)	10	-	ns	
WRX	t _{wc}	Write cycle	66	-	ns	
	t _{wrh}	Write Control pulse H duration	15	-	ns	
	t _{wrl}	Write Control pulse L duration	15	-	ns	
RDX (FM)	t _{rcfm}	Read Cycle (FM)	450	-	ns	
	t _{rdhfm}	Read Control H duration (FM)	90	-	ns	
	t _{rdlfm}	Read Control L duration (FM)	355	-	ns	
RDX (ID)	t _{rc}	Read cycle (ID)	160	-	ns	
	t _{rdh}	Read Control pulse H duration	90	-	ns	
	t _{rdl}	Read Control pulse L duration	45	-	ns	
D[17:0], D[15:0], D[8:0], D[7:0]	t _{dst}	Write data setup time	10	-	ns	For maximum CL=30pF For minimum CL=8pF
	t _{dht}	Write data hold time	10	-	ns	
	t _{rat}	Read access time	-	40	ns	
	t _{ratfm}	Read access time	-	340	ns	
	t _{rodh}	Read output disable time	20	80	ns	

Note: Ta = -30 to 70 °C, VDDI=1.65V to 3.3V, VCI=2.5V to 3.3V, VSS=0V



CSX timings :

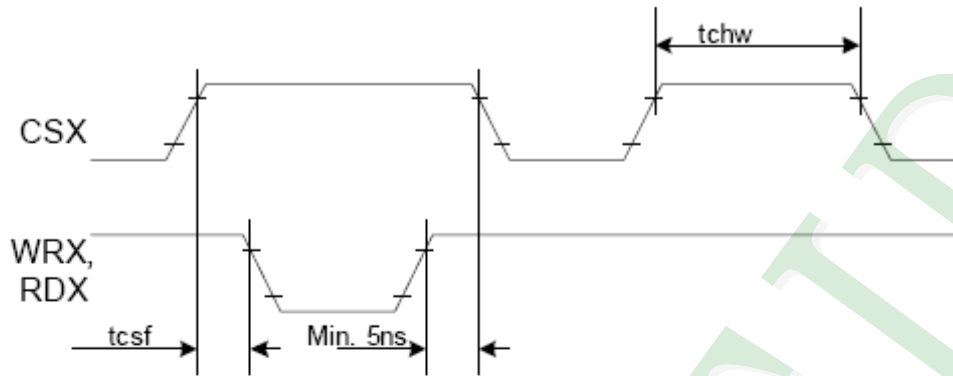

Note: Logic high and low levels are specified as 30% and 70% of VDDI for Input signals.

Write to read or read to write timings:

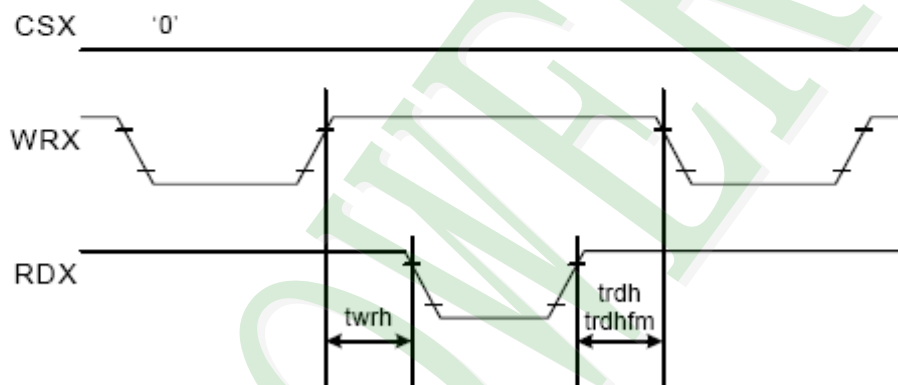

Note: Logic high and low levels are specified as 30% and 70% of VDDI for Input signals.

3. QUALITY ASSURANCE SYSTEM

3.1 Quality Assurance Flow Chart

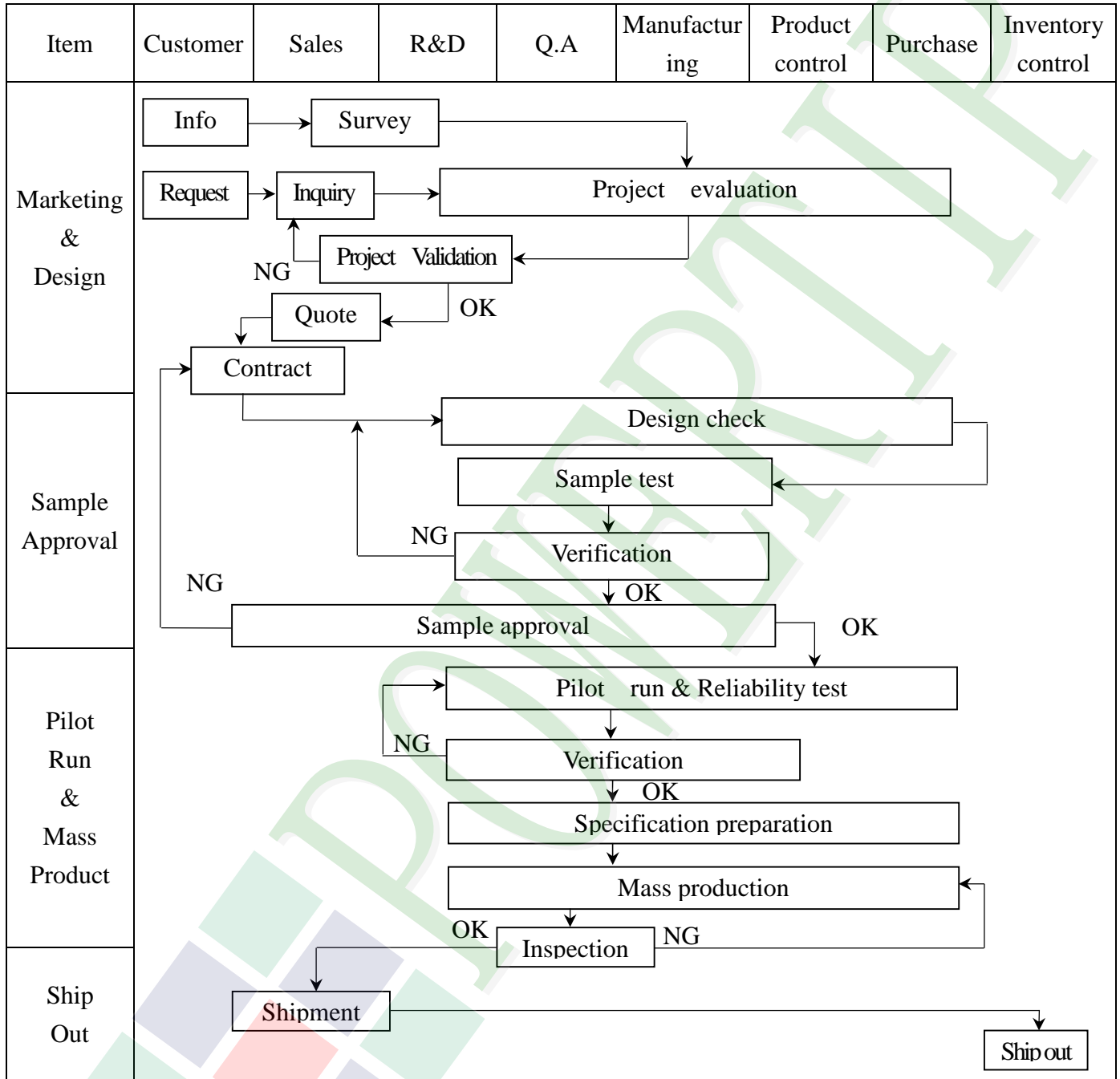

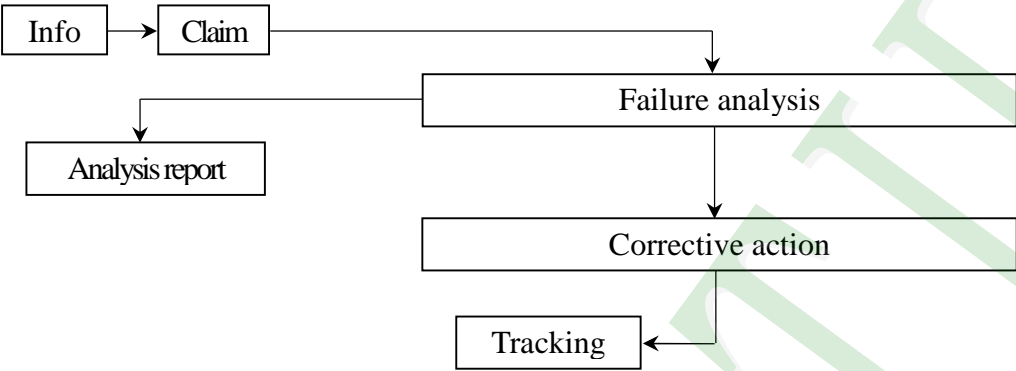
Item	Customer	Sales	R&D	Q.A	Manufacturing	Product control	Purchase	Inventory control
Sales Service	 <pre> graph TD Info[Info] --> Claim[Claim] Claim --> Failure[Failure analysis] Failure --> Analysis[Analysis report] Failure --> Corrective[Corrective action] Corrective --> Tracking[Tracking] </pre>							
Q.A Activity	1. ISO 9001 Maintenance Activities 3. Equipment calibration 5. Standardization Management				2. Process improvement proposal 4. Education And Training Activities			

3.2 Inspection Specification

- ◆Scope : The document shall be applied to TFT-LCD Module for less than 3.5" (Ver.B01).
- ◆Inspection Standard : MIL-STD-105E Table Normal Inspection Single Sampling Level II.
- ◆Equipment : Gauge、MIL-STD、Powertip Tester、Sample
- ◆Defect Level : Major Defect AQL : 0.4 ; Minor Defect AQL : 1.5
- ◆OUT Going Defect Level : Sampling.
- ◆Standard of the product appearance test :

a. Manner of appearance test :

- (1). The test best be under 20W×2 fluorescent light , and distance of view must be at 30 cm.
- (2). The test direction is base on about around 45° of vertical line.

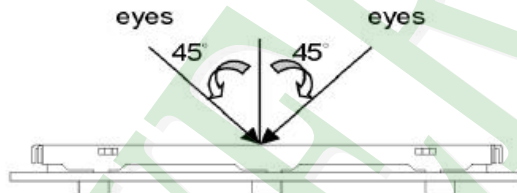

(3). Definition of area.

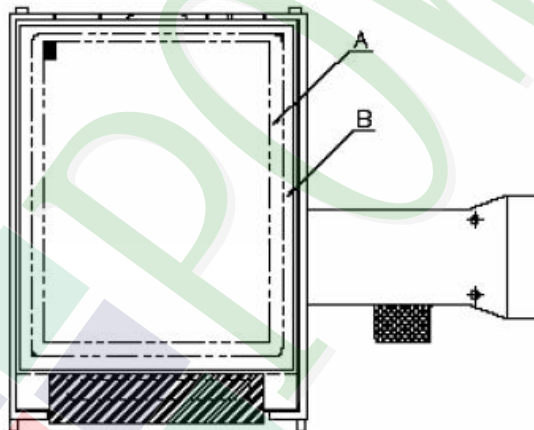

A area : viewing area

B area : Outside of viewing area

(4). Standard of inspection : (Unit : mm)

◆ Specification For TFT-LCD Module Less Than 3.5" :

(Ver.B01)

NO	Item	Criterion	Level												
01	Product condition	1. 1 The part number is inconsistent with work order of production.	Major												
		1. 2 Mixed product types.	Major												
		1. 3 Assembled in inverse direction.	Major												
02	Quantity	2. 1 The quantity is inconsistent with work order of production.	Major												
03	Outline dimension	3. 1 Product dimension and structure must conform to structure diagram.	Major												
04	Electrical Testing	4. 1 Missing line character and icon.	Major												
		4. 2 No function or no display.	Major												
		4. 3 Display malfunction.	Major												
		4. 4 LCD viewing angle defect.	Major												
		4. 5 Current consumption exceeds product specifications.	Major												
05	Dot defect (Bright dot 、 Dark dot) On -display	<table border="1"> <thead> <tr> <th></th> <th>Item</th> <th>Acceptance (Q'ty)</th> </tr> </thead> <tbody> <tr> <td rowspan="4">Dot Defect</td> <td>Bright Dot</td> <td>≤ 2</td> </tr> <tr> <td>Dark Dot</td> <td>≤ 3</td> </tr> <tr> <td>Joint Dot</td> <td>≤ 2</td> </tr> <tr> <td>Total</td> <td>≤ 3</td> </tr> </tbody> </table>		Item	Acceptance (Q'ty)	Dot Defect	Bright Dot	≤ 2	Dark Dot	≤ 3	Joint Dot	≤ 2	Total	≤ 3	Minor
			Item	Acceptance (Q'ty)											
Dot Defect	Bright Dot	≤ 2													
	Dark Dot	≤ 3													
	Joint Dot	≤ 2													
	Total	≤ 3													
5. 1 Inspection pattern : full white , full black , Red , Green and blue screens. 5. 2 It is defined as dot defect if defect area $> 1/2$ dot. 5. 3 The distance between two dot defect ≥ 5 mm.															

◆ Specification For TFT-LCD Module Less Than 3.5" :

(Ver.B01)

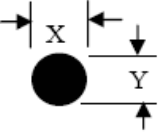
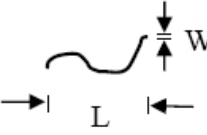
NO	Item	Criterion	Level																																								
06	<p>Black or white dot、scratch、contamination</p> <p>Round type</p>  <p>$\Phi = (x + y) / 2$</p> <p>Line type</p> 	<p>6.1 Round type (Non-display or display) :</p> <table border="1" data-bbox="590 436 1364 891"> <thead> <tr> <th rowspan="2">Dimension (diameter : Φ)</th> <th colspan="2">Acceptance (Q'ty)</th> </tr> <tr> <th>A area</th> <th>B area</th> </tr> </thead> <tbody> <tr> <td>$\Phi \leq 0.15$</td> <td colspan="2">Ignore</td> </tr> <tr> <td>$0.15 < \Phi \leq 0.20$</td> <td>2</td> <td rowspan="3">Ignore</td> </tr> <tr> <td>$0.20 < \Phi \leq 0.30$</td> <td>2</td> </tr> <tr> <td>$\Phi > 0.30$</td> <td>0</td> </tr> <tr> <td>Total</td> <td colspan="2">3</td> </tr> </tbody> </table> <p>6.2 Line type(Non-display or display) :</p> <table border="1" data-bbox="571 1003 1380 1417"> <thead> <tr> <th colspan="2">Dimension</th> <th colspan="2">Acceptance (Q'ty)</th> </tr> <tr> <th>Length (L)</th> <th>Width (W)</th> <th>A area</th> <th>B area</th> </tr> </thead> <tbody> <tr> <td>---</td> <td>$W \leq 0.03$</td> <td>Ignore</td> <td rowspan="3">Ignore</td> </tr> <tr> <td>$L \leq 5.0$</td> <td>$0.03 < W \leq 0.05$</td> <td>3</td> </tr> <tr> <td>---</td> <td>$W > 0.05$</td> <td>As round type</td> </tr> <tr> <td colspan="2">Total</td> <td colspan="2">3</td> </tr> </tbody> </table>	Dimension (diameter : Φ)	Acceptance (Q'ty)		A area	B area	$\Phi \leq 0.15$	Ignore		$0.15 < \Phi \leq 0.20$	2	Ignore	$0.20 < \Phi \leq 0.30$	2	$\Phi > 0.30$	0	Total	3		Dimension		Acceptance (Q'ty)		Length (L)	Width (W)	A area	B area	---	$W \leq 0.03$	Ignore	Ignore	$L \leq 5.0$	$0.03 < W \leq 0.05$	3	---	$W > 0.05$	As round type	Total		3		Minor
Dimension (diameter : Φ)	Acceptance (Q'ty)																																										
	A area	B area																																									
$\Phi \leq 0.15$	Ignore																																										
$0.15 < \Phi \leq 0.20$	2	Ignore																																									
$0.20 < \Phi \leq 0.30$	2																																										
$\Phi > 0.30$	0																																										
Total	3																																										
Dimension		Acceptance (Q'ty)																																									
Length (L)	Width (W)	A area	B area																																								
---	$W \leq 0.03$	Ignore	Ignore																																								
$L \leq 5.0$	$0.03 < W \leq 0.05$	3																																									
---	$W > 0.05$	As round type																																									
Total		3																																									
07	<p>Polarizer Bubble</p>	<table border="1" data-bbox="582 1467 1372 1877"> <thead> <tr> <th rowspan="2">Dimension (diameter : Φ)</th> <th colspan="2">Acceptance (Q'ty)</th> </tr> <tr> <th>A area</th> <th>B area</th> </tr> </thead> <tbody> <tr> <td>$\Phi \leq 0.20$</td> <td colspan="2">Ignore</td> </tr> <tr> <td>$0.20 < \Phi \leq 0.50$</td> <td>3</td> <td rowspan="3">Ignore</td> </tr> <tr> <td>$\Phi > 0.50$</td> <td>0</td> </tr> <tr> <td>Total</td> <td colspan="2">3</td> </tr> </tbody> </table>	Dimension (diameter : Φ)	Acceptance (Q'ty)		A area	B area	$\Phi \leq 0.20$	Ignore		$0.20 < \Phi \leq 0.50$	3	Ignore	$\Phi > 0.50$	0	Total	3		Minor																								
Dimension (diameter : Φ)	Acceptance (Q'ty)																																										
	A area	B area																																									
$\Phi \leq 0.20$	Ignore																																										
$0.20 < \Phi \leq 0.50$	3	Ignore																																									
$\Phi > 0.50$	0																																										
Total	3																																										

◆Specification For TFT-LCD Module Less Than 3.5" :

(Ver.B01)

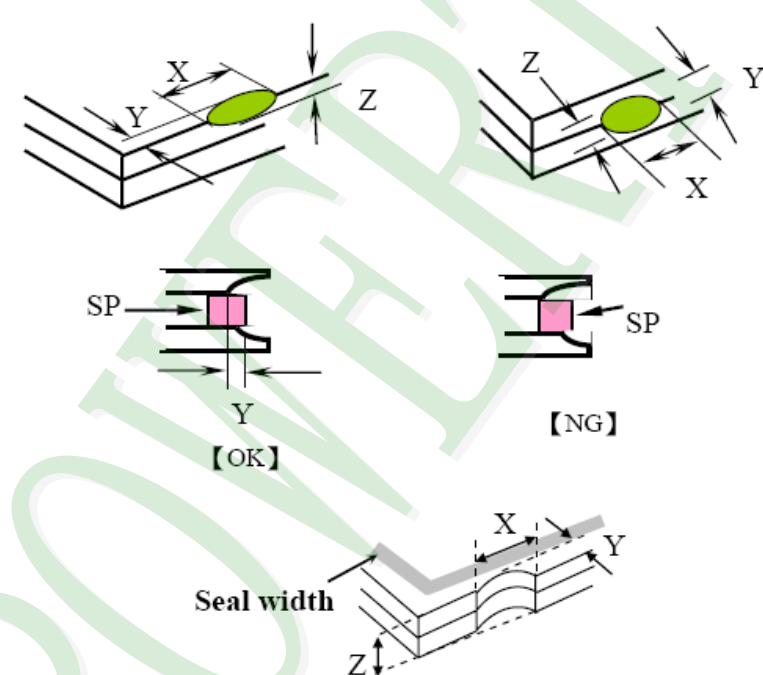
NO	Item	Criterion	Level						
08	The crack of glass	<p>Symbols :</p> <p>X : The length of crack Z : The thickness of crack t : The thickness of glass</p> <p>Y : The width of crack. W : terminal length a : LCD side length</p>	Minor						
		<p>8.1 General glass chip :</p> <p>8.1.1 Chip on panel surface and crack between panels:</p>  <table border="1" data-bbox="542 1456 1340 1747"> <thead> <tr> <th>X</th> <th>Y</th> <th>Z</th> </tr> </thead> <tbody> <tr> <td>$\geq a$</td> <td>Crack can't enter viewing area</td> <td>$\leq 1/2 t$</td> </tr> <tr> <td>$\geq a$</td> <td>Crack can't exceed the half of SP width.</td> <td>$1/2 t < Z \leq 2 t$</td> </tr> </tbody> </table>		X	Y	Z	$\geq a$	Crack can't enter viewing area	$\leq 1/2 t$
X	Y	Z							
$\geq a$	Crack can't enter viewing area	$\leq 1/2 t$							
$\geq a$	Crack can't exceed the half of SP width.	$1/2 t < Z \leq 2 t$							

◆ Specification For TFT-LCD Module Less Than 3.5" :

(Ver.B01)

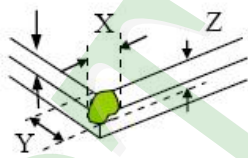
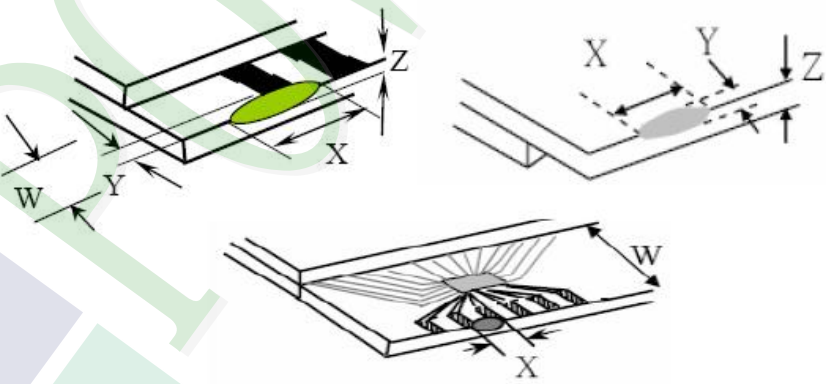
NO	Item	Criterion	Level									
08	The crack of glass	<p>Symbols :</p> <p>X : The length of crack Z : The thickness of crack t : The thickness of glass</p> <p>Y : The width of crack. W : terminal length a : LCD side length</p>	Minor									
		<p>8.1.2 Corner crack :</p>  <table border="1" data-bbox="526 784 1332 1075"> <thead> <tr> <th>X</th> <th>Y</th> <th>Z</th> </tr> </thead> <tbody> <tr> <td>$\leq 1/5 a$</td> <td>Crack can't enter viewing area</td> <td>$Z \leq 1/2 t$</td> </tr> <tr> <td>$\leq 1/5 a$</td> <td>Crack can't exceed the half of SP width.</td> <td>$1/2 t < Z \leq 2 t$</td> </tr> </tbody> </table>		X	Y	Z	$\leq 1/5 a$	Crack can't enter viewing area	$Z \leq 1/2 t$	$\leq 1/5 a$	Crack can't exceed the half of SP width.	$1/2 t < Z \leq 2 t$
		X		Y	Z							
$\leq 1/5 a$	Crack can't enter viewing area	$Z \leq 1/2 t$										
$\leq 1/5 a$	Crack can't exceed the half of SP width.	$1/2 t < Z \leq 2 t$										
<p>8.2 Protrusion over terminal :</p> <p>8.2.1 Chip on electrode pad :</p>  <table border="1" data-bbox="566 1668 1340 1848"> <thead> <tr> <th></th> <th>X</th> <th>Y</th> <th>Z</th> </tr> </thead> <tbody> <tr> <td>Front</td> <td>$\leq a$</td> <td>$\leq 1/2 W$</td> <td>$\leq t$</td> </tr> <tr> <td>Back</td> <td>$\leq a$</td> <td>$\leq W$</td> <td>$\leq 1/2 t$</td> </tr> </tbody> </table>		X	Y	Z	Front	$\leq a$	$\leq 1/2 W$	$\leq t$	Back	$\leq a$	$\leq W$	$\leq 1/2 t$
	X	Y	Z									
Front	$\leq a$	$\leq 1/2 W$	$\leq t$									
Back	$\leq a$	$\leq W$	$\leq 1/2 t$									

◆Specification For TFT-LCD Module Less Than 3.5" :

(Ver.B01)

NO	Item	Criterion	Level
09	Backlight elements	9.1 Backlight can't work normally.	Major
		9.2 Backlight doesn't light or color is wrong.	Major
		9.3 Illumination source flickers when lit.	Major
10	General appearance	10.1 Pin type 、 quantity 、 dimension must match type in structure diagram.	Major
		10.2 No short circuits in components on PCB or FPC .	Major
		10.3 Parts on PCB or FPC must be the same as on the production characteristic chart .There should be no wrong parts , missing parts or excess parts.	Major
		10.4 Product packaging must the same as specified on packaging specification sheet.	Minor
		10.5 The folding and peeled off in polarizer are not acceptable.	Minor
		10.6 The PCB or FPC between B/L assembled distance(PCB or FPC) is ≤ 1.5 mm.	Minor

4. RELIABILITY TEST

4.1 Reliability Test Condition

(Ver.B01)

NO.	TEST ITEM	TEST CONDITION										
1	High Temperature Storage Test	Keep in $+80^{\circ}\text{C} \pm 2^{\circ}\text{C}$ 96 hrs Surrounding temperature, then storage at normal condition 4hrs.										
2	Low Temperature Storage Test	Keep in $-30^{\circ}\text{C} \pm 2^{\circ}\text{C}$ 96 hrs Surrounding temperature, then storage at normal condition 4hrs.										
3	High Temperature / High Humidity Storage Test	Keep in $+60^{\circ}\text{C}$ / 90% R.H duration for 96 hrs Surrounding temperature, then storage at normal condition 4hrs. (Excluding the polarizer)										
4	Temperature Cycling Storage Test	<p style="text-align: center;"> $-30^{\circ}\text{C} \xrightarrow{(30\text{mins})} +25^{\circ}\text{C} \xrightarrow{(5\text{mins})} +80^{\circ}\text{C} \xrightarrow{(30\text{mins})} +25^{\circ}\text{C} \xrightarrow{(5\text{mins})}$ 10 Cycle </p> <p style="text-align: center;">Surrounding temperature, then storage at normal condition 4hrs.</p>										
5	ESD Test	Air Discharge: Apply 2 KV with 5 times Discharge for each polarity +/-										
		Contact Discharge: Apply 250 V with 5 times discharge for each polarity +/-										
		1. Temperature ambience : $15^{\circ}\text{C} \sim 35^{\circ}\text{C}$ 2. Humidity relative : 30% ~ 60% 3. Energy Storage Capacitance(Cs+Cd) : $150\text{pF} \pm 10\%$ 4. Discharge Resistance(Rd) : $330\Omega \pm 10\%$ 5. Discharge, mode of operation : Single Discharge (time between successive discharges at least 1 sec) (Tolerance if the output voltage indication : $\pm 5\%$)										
6	Vibration Test (Packaged)	1. Sine wave 10~55 Hz frequency (1 min/sweep) 2. The amplitude of vibration : 1.5 mm 3. Each direction (X、Y、Z) duration for 2 Hrs										
7	Drop Test (Packaged)	<table border="1" style="width: 100%; border-collapse: collapse;"> <thead> <tr> <th>Packing Weight (Kg)</th> <th>Drop Height (cm)</th> </tr> </thead> <tbody> <tr> <td>0 ~ 45.4</td> <td>122</td> </tr> <tr> <td>45.4 ~ 90.8</td> <td>76</td> </tr> <tr> <td>90.8 ~ 454</td> <td>61</td> </tr> <tr> <td>Over 454</td> <td>46</td> </tr> </tbody> </table>	Packing Weight (Kg)	Drop Height (cm)	0 ~ 45.4	122	45.4 ~ 90.8	76	90.8 ~ 454	61	Over 454	46
		Packing Weight (Kg)	Drop Height (cm)									
0 ~ 45.4	122											
45.4 ~ 90.8	76											
90.8 ~ 454	61											
Over 454	46											
		Drop Direction : ※1 corner / 3 edges / 6 sides each 1time										

5. PRECAUTION RELATING PRODUCT HANDLING

5.1 SAFETY

- 5.1.1 If the LCD panel breaks , be careful not to get the liquid crystal to touch your skin.
- 5.1.2 If the liquid crystal touches your skin or clothes , please wash it off immediately by using soap and water.

5.2 HANDLING

- 5.2.1 Avoid any strong mechanical shock which can break the glass.
- 5.2.2 Avoid static electricity which can damage the CMOS LSI—When working with the module , be sure to ground your body and any electrical equipment you may be using.
- 5.2.3 Do not remove the panel or frame from the module.
- 5.2.4 The polarizing plate of the display is very fragile. So , please handle it very carefully, do not touch , push or rub the exposed polarizing with anything harder than an HB pencil lead (glass , tweezers , etc.)
- 5.2.5 Do not wipe the polarizing plate with a dry cloth , as it may easily scratch the surface of plate.
- 5.2.6 Do not touch the display area with bare hands , this will stain the display area.
- 5.2.7 Do not use ketonics solvent & aromatic solvent. Use with a soft cloth soaked with a cleaning naphtha solvent.
- 5.2.8 To control temperature and time of soldering is $320 \pm 10^{\circ}\text{C}$ and 3-5 sec.
- 5.2.9 To avoid liquid (include organic solvent) stained on LCM

5.3 STORAGE

- 5.3.1 Store the panel or module in a dark place where the temperature is $25^{\circ}\text{C} \pm 5^{\circ}\text{C}$ and the humidity is below 65% RH.
- 5.3.2 Do not place the module near organics solvents or corrosive gases.
- 5.3.3 Do not crush , shake , or jolt the module.

5.4 TERMS OF WARRANTY

- 5.4.1 Applicable warrant period
The period is within thirteen months since the date of shipping out under normal using and storage conditions.
- 5.4.2 Unaccepted responsibility
This product has been manufactured to your company's specification as a part for use in your company's general electronic products. It is guaranteed to perform according to delivery specifications. For any other use apart from general electronic equipment, we cannot take responsibility if the product is used in nuclear power control equipment, aerospace equipment , fire and security systems or any other applications in which there is a direct risk to human life and where extremely high levels of reliability are required.

1. 包裝材料規格表 (Packaging Material) : (per carton)

No.	Item	Model	Dimensions (mm)	1Pcs Weight	Quantity	Total Weight
1	成品 (LCM)	PH240320T-062-L06Q	42.72 X 60.26	0.0174	468	8.1432
2	靜電袋(1)Antistatic Bag	BAG100100ARABA	100 X 100	0.0011	468	0.5148
3	氣泡袋(2)Bubble Bag	BAG100065BRABA	100 X 65	0.0008	468	0.3744
4	A1-1隔板(3)A1-1 Partition	BX29500047BZBA	295 X 47 X 3	0.0078	168	1.3104
5	B1-1隔板(4)B1-1 Partition	BX24500047BZBA	245 X 47 X 3	0.0065	48	0.312
6	氣泡紙(5)Bubble Sheet	BAG280240BWABA	280 X 240	0.006	24	0.144
7	C1內盒(6)Product Box	BX31025555AABA	310 X 255 X 55	0.13	12	1.56
8	外紙箱(7)Carton	BX52732536CCBA	527 X 325 X 360	0.83	1	0.83
9						

2. 一整箱總重量 (Total LCD Weight in carton) : 13.19 Kg±10%

3. 單箱數量規格表 (Packaging Specifications and Quantity) :

(1)Quantity Of Spacer : A1-1隔板 X 14 , B1-1隔板 X 4

(2)Total LCM quantity in carton : quantity per box 39 x no of boxes 12 = 468

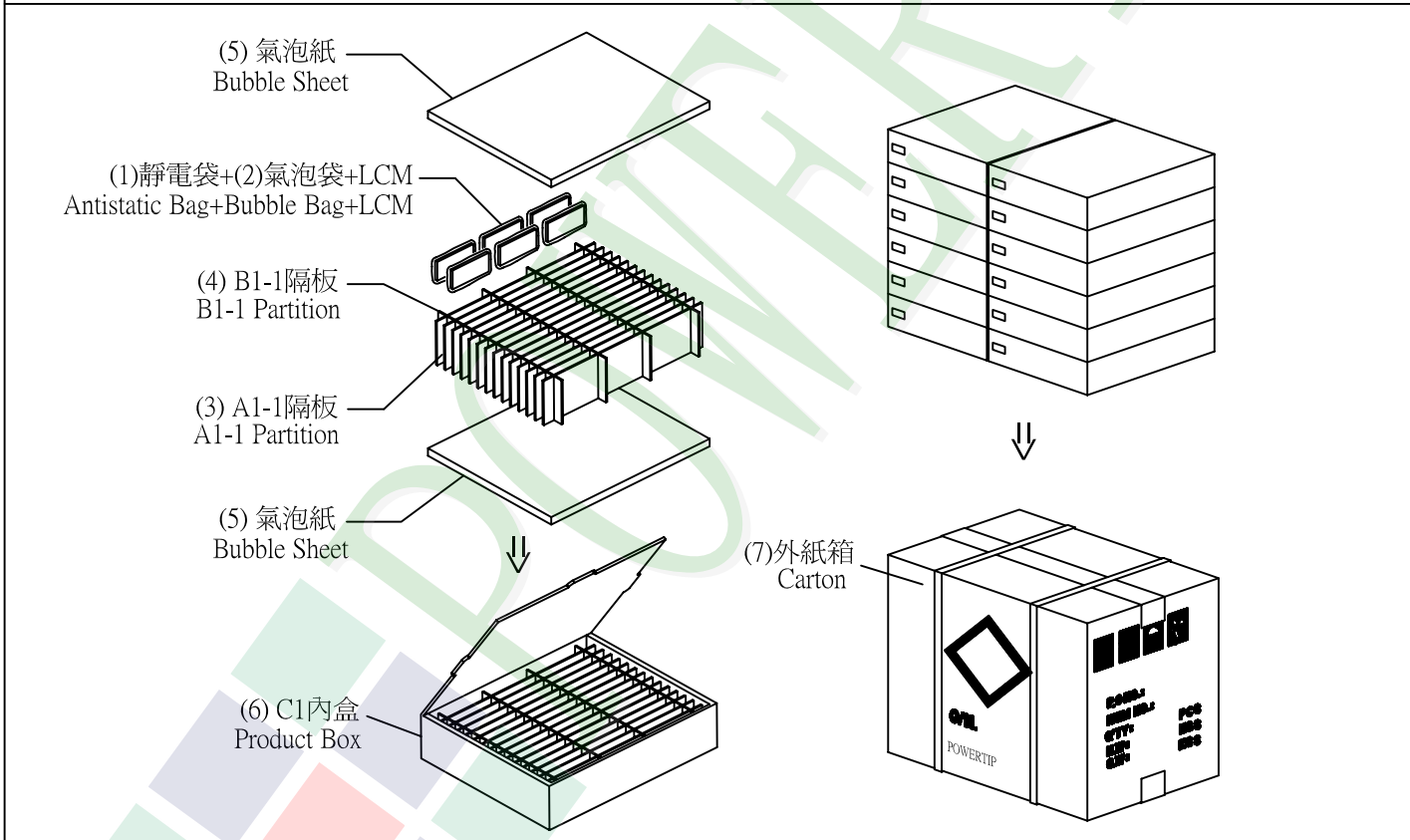

特 記 事 項 (REMARK)

4. Label Specifications :

TYPE			
ID.NO	S/O		
Q'TY	Pcs	Date	
Lot.NO			
Note			

參照"成品包裝點檢作業標準書"內容

5. LCM排放示意圖(前後間隔不放置):
5. LCM placed as figure showing:
(First and last slot should be empty)

▨ 模組(LCM) X 1pcs.