

SPECIFICATIONS

CUSTOMER	:	CDE012
SAMPLE CODE	:	SH320240T023-IHA
MASS PRODUCTION CODE	:	PH320240T023-IHA
SAMPLE VERSION	:	02
SPECIFICATIONS EDITION	:	003
DRAWING NO. (Ver.)	:	JLMD-PH320240T023-IHA_001
PACKAGING NO. (Ver.)	:	JPKG-PH320240T023-IHA_001

Customer Approved

Date:

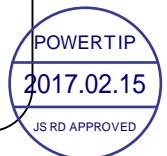

Approved	Checked	Designer
閔偉	張久慧	劉進

- Preliminary specification for design input
 Specification for sample approval

POWERTIP TECH. CORP.

Headquarters: No.8, 6th Road, Taichung Industrial Park,
Taichung, Taiwan
台中市 407 工業區六路 8 號

TEL: 886-4-2355-8168

FAX: 886-4-2355-8166

E-mail: sales@powertip.com.tw

[Http://www.powertip.com.tw](http://www.powertip.com.tw)

Contents

1. SPECIFICATIONS

- 1.1 Features
- 1.2 Mechanical Specifications
- 1.3 Absolute Maximum Ratings
- 1.4 DC Electrical Characteristics
- 1.5 Optical Characteristics
- 1.6 Backlight Characteristics

2. MODULE STRUCTURE

- 2.1 Counter Drawing
- 2.2 Interface Pin Description
- 2.3 Timing Characteristics
- 2.4 Power Sequence

3. QUALITY ASSURANCE SYSTEM

- 3.1 Quality Assurance Flow Chart
- 3.2 Inspection Specification

4. RELIABILITY TEST

- 4.1 Reliability Test Condition

5. PRECAUTION RELATING PRODUCT HANDLING

- 5.1 Safety
- 5.2 Handling
- 5.3 Storage
- 5.4 Terms of Warranty

Appendix : LCM Drawing
Packaging

Note : For detailed information please refer to IC data sheet :

Primacy(TFT LCD): Himax: HX8238-D

1. SPECIFICATIONS

1.1 Features

Item	Standard Value
Display Resolution	320 * (RGB) * 240 Dots
LCD Type	a-Si TFT , Normally white , Transmissive type
Screen size(inch)	3.5 inch
Viewing Direction	6 O'clock
Surface treatment	Clear
Color configuration	R.G.B. Vertical Stripe
Backlight Type	LED B/L
Weight	-
Interface	24 Bits RGB Interface
Other (controller / driver IC)	Himax: HX8238-D
ROHS	THIS PRODUCT CONFORMS THE ROHS OF PTC Detail information please refer website : http://www.powertip.com.tw/news.php?area_id_view=1085560481/

1.2 Mechanical Specifications

Item	Standard Value	Unit
Outline Dimension	76.9(W) * 63.9 (L) * 3.2 (H)	mm

LCD panel

Item	Standard Value	Unit
Active Area	70.08 (W) * 52.56 (L)	mm

Note : For detailed information please refer to LCM drawing.

1.3 Absolute Maximum Ratings

Module

Item	Symbol	Condition	Min.	Max.	Unit	Remark
Power Supply Voltage	VDD	GND=0	-0.3	3.96	V	-
Power Supply Voltage	VCC	GND=0	-0.3	+23.0	V	
Operating Temperature	T _{OP}	-	-20	+70	°C	
Storage Temperature	T _{ST}	-	-30	+80	°C	

The absolute maximum rating values of this product are not allowed to be exceeded at any times. Should a module be used with any of the absolute maximum ratings exceeded, the characteristics of the module may not be recovered, or in an extreme case, the module may be permanently destroyed.

1.4 DC Electrical Characteristics

Module

T_a = 25°C

Item	Symbol	Condition	Min.	Typ.	Max.	Unit
Power Supply for TFT Panel	VDD	GND=0V	3.0	3.3	3.6	V
Power Supply for Backlight Unit	VCC	GND=0V	5	12	14	V
Input Voltage for TFT Panel	V _{IH}	GND=0V	0.7VDD	-	VDD	V
	V _{IL}	GND=0V	0	-	0.3VDD	V
Supply Current for TFT Panel	IDD	IDD@VDD=3.3V	-	11	17	mA
Supply Current for Backlight Unit	ICC	ICC@VCC=5V	-	100	150	mA
		ICC@VCC=12V	-	50	75	mA
Input Voltage for PWM Signal	VPH	GND=0V	1.2	-	-	V
	VPL	GND=0V	-	-	0.4	V
Dimming Clock Rate	fP	GND=0V	5	-	100	KHz

1.5 Optical Characteristics

VDD=3.3V, Ta=25°C

Item	Symbol	Condition	Min.	Typ.	Max.	unit	-	
Response time	Tr + Tf	-	-	40	60	ms	Note2	
Viewing angle	Top	$\theta+$	CR \geq 10	-	60	-	Deg.	Note4
	Bottom	$\theta-$		-	60	-		
	Left	θ_L		-	60	-		
	Right	θ_R		-	60	-		
Contrast ratio	CR	-	500	600	-	-	Note3	
Color of CIE Coordinate (LCD & B/L)	White	X	VCC=12V PWM="High" (Duty=100%)	0.27	0.32	0.37	-	Note1
		Y		0.30	0.35	0.40		
	Red	X		0.59	0.64	0.69		
		Y		0.29	0.34	0.39		
	Green	X		0.29	0.34	0.39		
		Y		0.56	0.61	0.66		
	Blue	X		0.09	0.14	0.19		
		Y		0.03	0.08	0.13		
Average Brightness Pattern=white display (LCD & B/L)*1	IV	VCC=12V PWM="High" (Duty=100%)	800	1000	-	cd/m ²		
Uniformity (LCD & B/L)*2	ΔB		70	-	-	%		

Note 1:

*1 : $\Delta B = B(\text{min}) / B(\text{max}) * 100\%$

*2 : Measurement Condition for Optical Characteristics:

- a : Environment: $25^{\circ}\text{C} \pm 5^{\circ}\text{C} / 60 \pm 20\% \text{R.H}$, no wind , dark room below 10 Lux at typical lamp current and typical operating frequency.
- b : Measurement Distance: $500 \pm 50 \text{ mm}$, ($\theta = 0^{\circ}$)
- c : Equipment: TOPCON BM-7 fast , (field 1°) , after 10 minutes operation.
- d : The uncertainty of the C.I.E coordinate measurement ± 0.01 , Average Brightness $\pm 4\%$

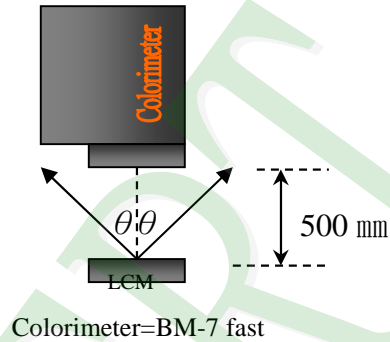
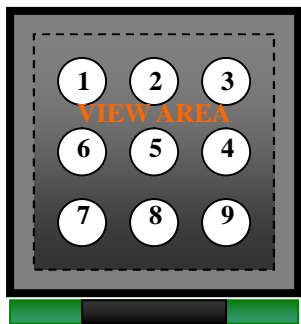

To be measured at the center area of panel with a viewing cone of 1° by Topcon luminance meter BM-7, after 10 minutes operation (module)

Note2: Definition of response time:

The output signals of photo detector are measured when the input signals are changed from “black” to “white”(falling time) and from “white” to “black”(rising time), respectively. The response time is defined as the time interval between the 10% and 90% of Amplitudes.

Refer to figure as below:

Normally White



Normally Black

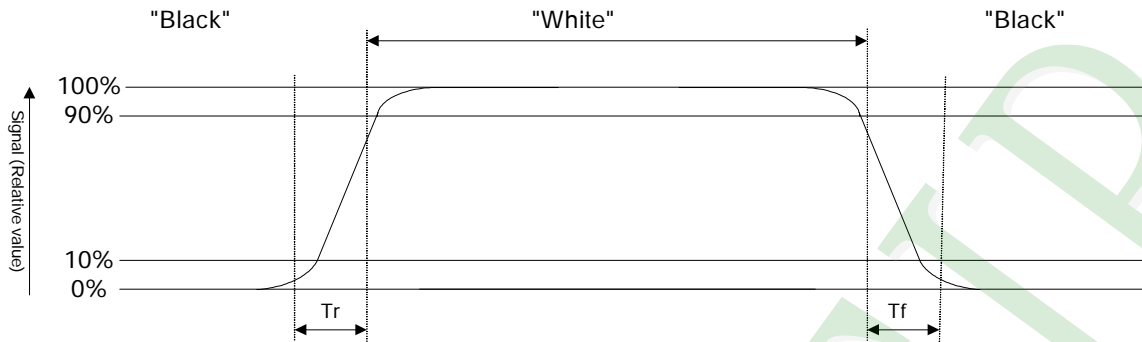

Note3: Definition of contrast ratio:

Contrast ratio is calculated with the following formula

$$\text{Contrast ratio (CR)} = \frac{\text{Photo detector output when LCD is at "White" state}}{\text{Photo detector output when LCD is at "Black" state}}$$

Note4: Definition of viewing angle:

Refer to figure as below:

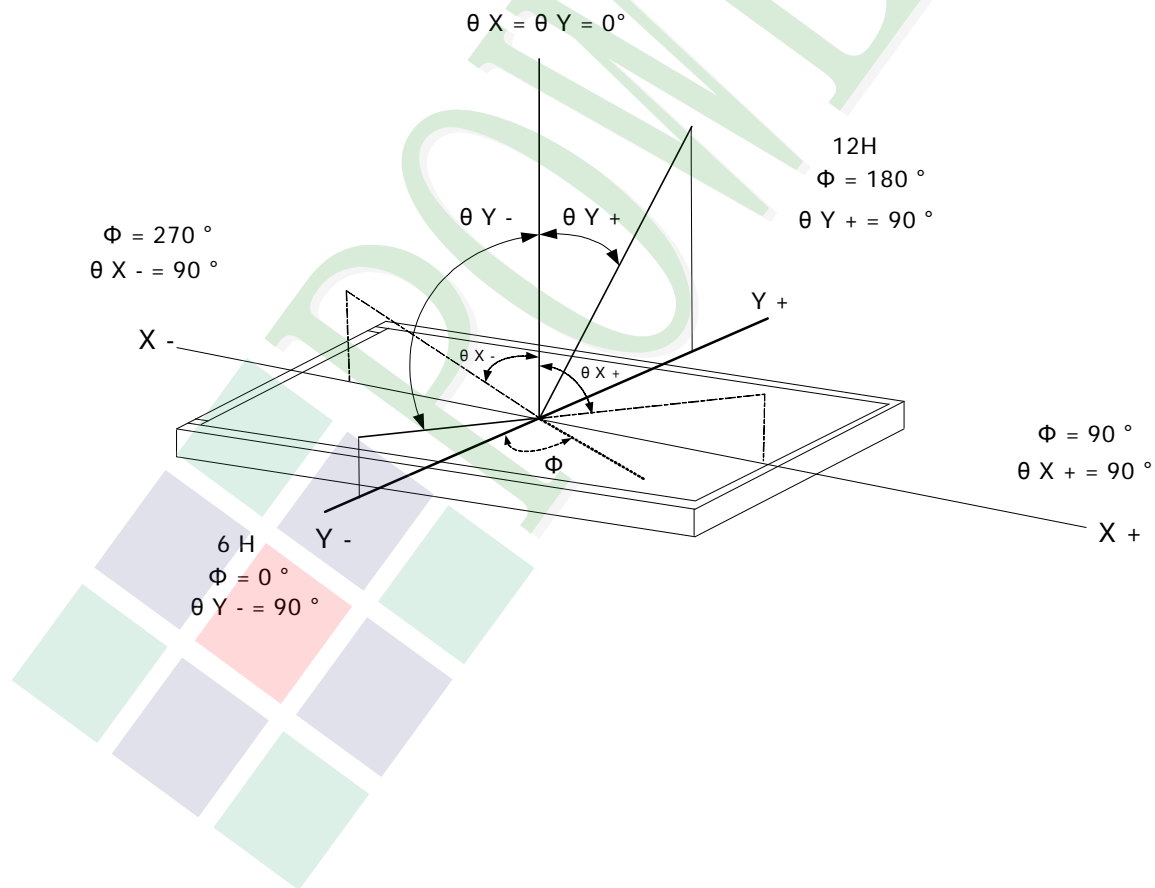

1.6 Backlight Characteristics

Maximum Ratings

Item	Symbol	Min.	Max.	Unit	Remark
LED Forward Current	I_F		30	mA	One LED
LED Reverse Voltage	V_R		5	V	

Electrical / Optical Characteristics

Item	Symbol	Min.	Typ.	Max.	Unit	Remark
LED Voltage	V_L	18	19	19.8	V	Note1
LED Current	I_L	-	20	-	mA	-
LED life time	-	50000	-	-	Hr	Note2

Note 1: The LED Supply Voltage is defined by the number of LED at $T_a=25^\circ\text{C}$ and $I_L=20\text{ mA}$.

Note 2: The "LED life time" is defined as the module brightness decrease to 50% original brightness at $T_a=25^\circ\text{C}$ and $I_L=20\text{ mA}$. The LED life time could be decreased if operating I_L is larger than 20 mA.

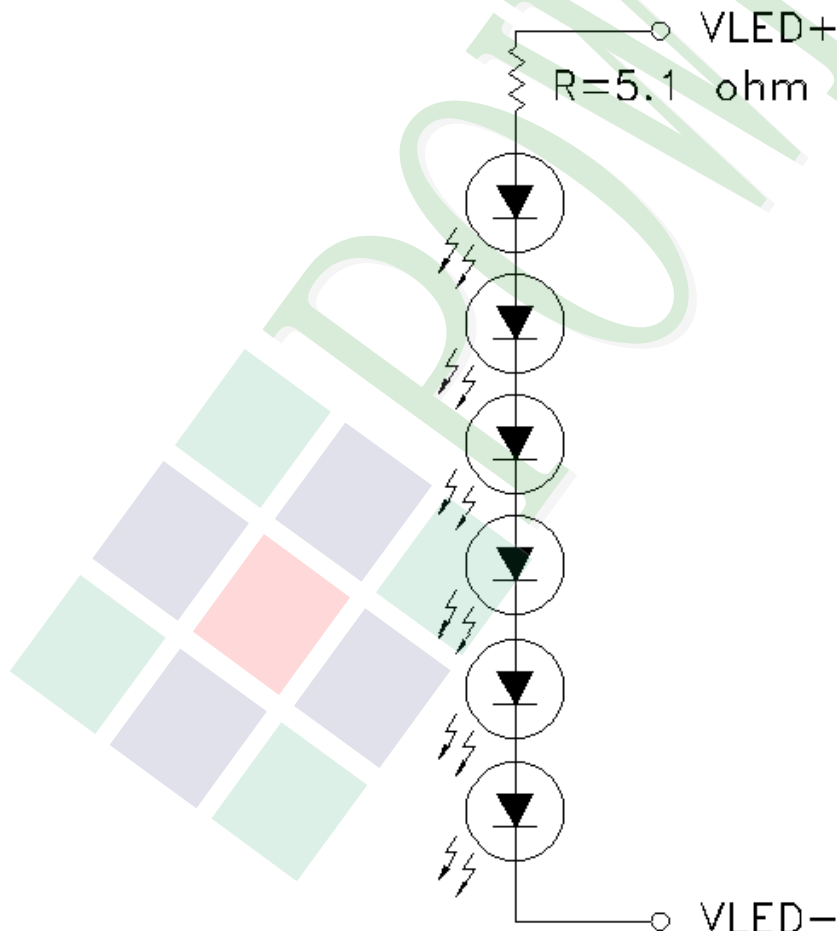

2. MODULE STRUCTURE

2.1 Counter Drawing

2.1.1 LCM Mechanical Diagram

* See Appendix

2.1.2 Block Diagram

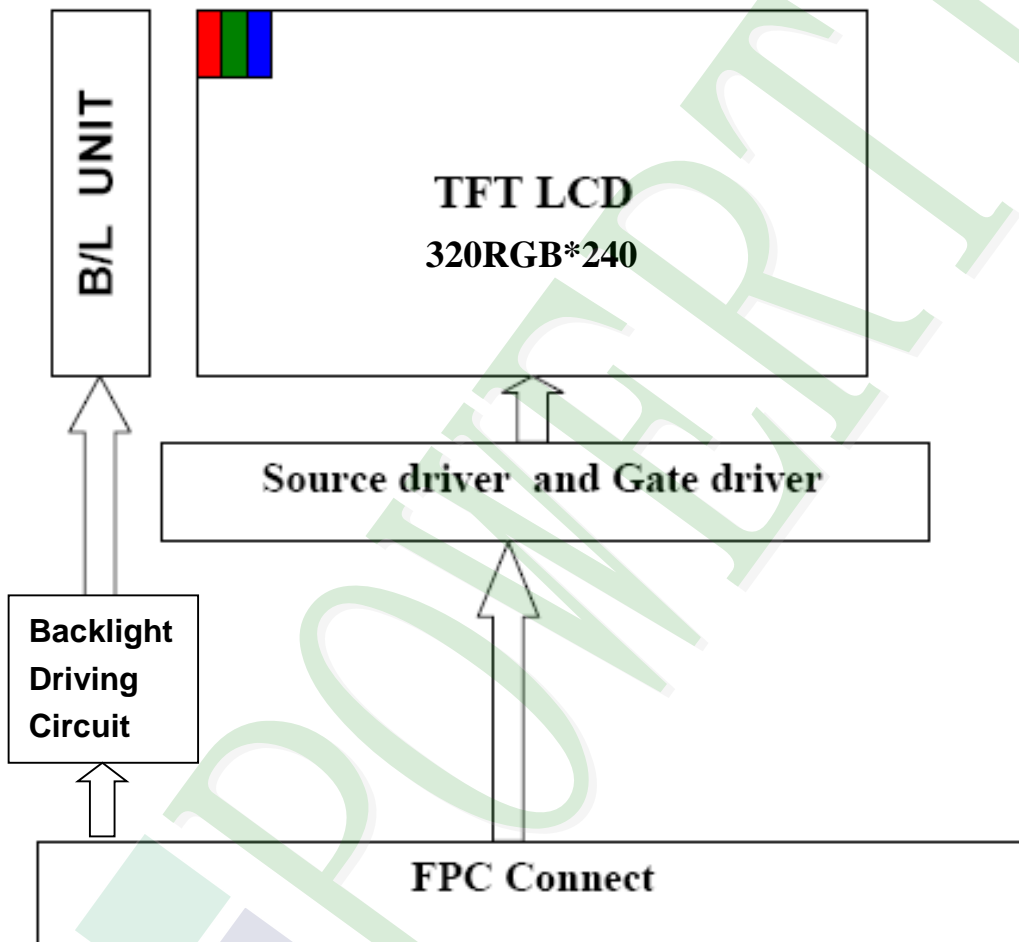

2.2 Interface Pin Description

Pin No.	Symbol	Function
1	GND	Power ground.
2	VDD	Power for Digital Circuit.
3	VDD	Power for Digital Circuit.
4	VCC	Power For LED backlight.
5	VCC	Power For LED backlight.
6	PWM	Shutdown & Dimming control input for backlight. Do not allow this pin to float. "Hi" =100%, "Low" = 0%.
7	GND	Power ground.
8	R0	Red Data.
9	R1	Red Data.
10	R2	Red Data.
11	R3	Red Data.
12	GND	Power ground.
13	R4	Red Data.
14	R5	Red Data.
15	R6	Red Data.
16	R7	Red Data.
17	GND	Power ground.
18	G0	Green Data.
19	G1	Green Data.
20	G2	Green Data.
21	G3	Green Data.
22	GND	Power ground.
23	G4	Green Data.
24	G5	Green Data.
25	G6	Green Data.
26	G7	Green Data.
27	GND	Power ground.
28	B0	Blue Data.
29	B1	Blue Data.

Pin No.	Symbol	Function
30	B2	Blue Data.
31	B3	Blue Data.
32	GND	Power ground.
33	B4	Blue Data.
34	B5	Blue Data.
35	B6	Blue Data.
36	B7	Blue Data.
37	GND	Power ground.
38	HS	Line synchronization signal. Horizontal Sync Input.
39	VS	Frame synchronization signal. Vertical Sync Input.
40	GND	Power ground.
41	DE	Display enable pin from controller. Data Input Enable.
42	GND	Power ground.
43	DCLK	Sample clock. Data will be latched at the falling edge of DCLK.
44	GND	Power ground.
45	CS / ID1	Chip Select/ ID[4:1]These pins select LCM type.
46	SDIN / ID2	SPI Data/ ID[4:1]These pins select LCM type.
47	SCK / ID3	SPI Clock/ ID[4:1]These pins select LCM type.
48	DISPLAY CONTROL / ID4	Display Enable (Hi Active) / ID[4:1]These pins select LCM type.
49	/RESET	Global Reset (Low Active).
50	GND	Power ground.

2.2.1 Refer Initial Code

HX8238-D register configuration is recommended to use the default value (HSP=0, VSP=0, CKP=0, DEP=0).

Note:
HSP: When HSP=0, HS(HSYNC) is negative polarity. When HSP=1, HS(HSYNC) is positive polarity.
VSP: When VSP=0, VS(VSYNC) is negative polarity. When VSP=1, VS(VSYNC) is positive polarity.
CKP: When CKP=0, data is latched in DCLK falling edge. When CKP=1, data is latched in DCLK rising edge.
DEP: When DEP=0, DE is negative polarity active. When DEP=1, DE is positive polarity active.

2.3 Timing Characteristics

2.3.1 Pixel timing for HX8238-D

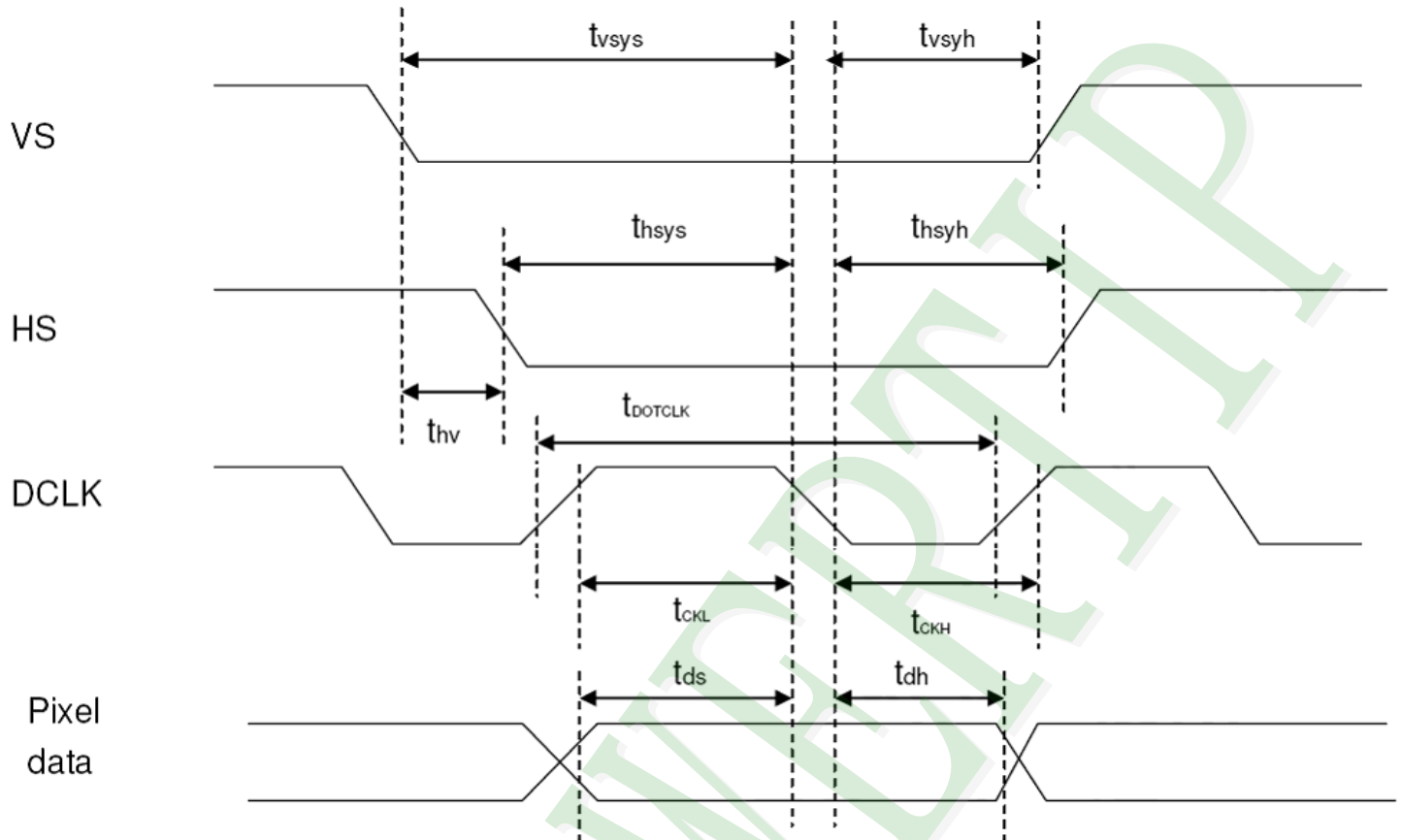

Characteristics	Symbol	Min	Typ	Max	Unit
DCLK Frequency	f _{DCLK}	-	6.5	10	MHz
DCLK Period	t _{DCLK}	100	154	-	ns
Vertical Sync Setup Time	t _{vsys}	20	-	-	ns
Vertical Sync Hold Time	t _{vsyh}	20	-	-	ns
Horizontal Sync Setup Time	t _{hsys}	20	-	-	ns
Horizontal Sync Hold Time	t _{hsyh}	20	-	-	ns
Phase difference of Sync Signal Falling Edge	t _{thv}	1	-	240	t _{DCLK}
DCLK Low Period	t _{CKL}	50	-	-	ns
DCLK High Period	t _{CKH}	50	-	-	ns
Data Setup Time	t _{ds}	12	-	-	ns
Data hold Time	t _{dh}	12	-	-	ns
Reset pulse width	t _{RES}	10	-	-	μs

Note: External clock source must be provided to DOTCLK pin of HX8238-A. The driver will not operate if absent of the clocking signal.

Pixel timing

2.3.2 Data transaction timing for HX8238-D

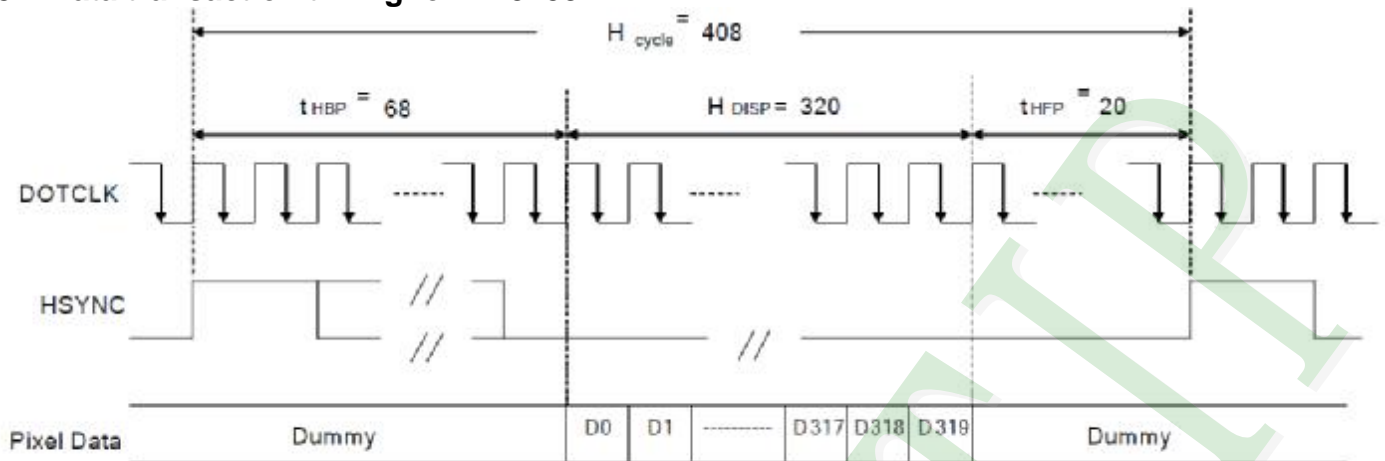

(a) Horizontal Data Transaction Timing

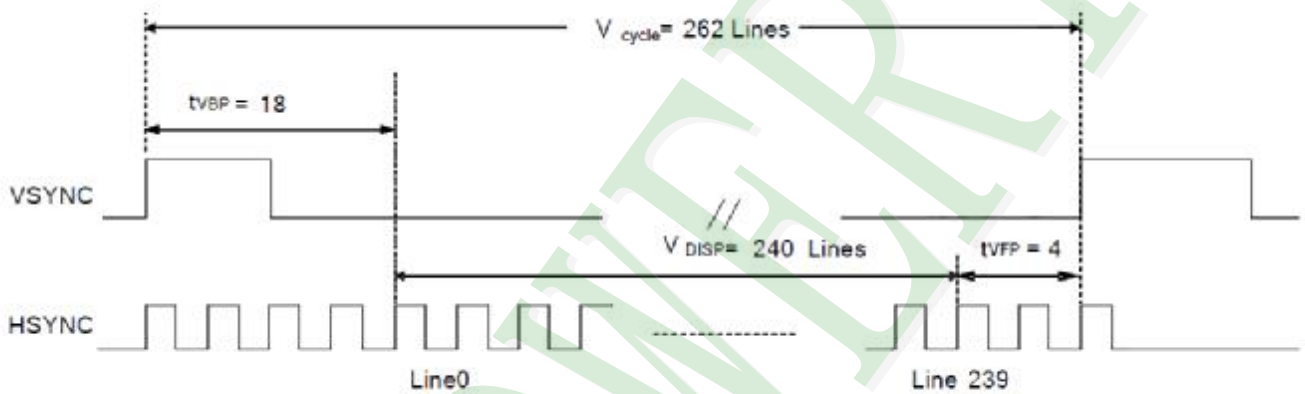

(b) Vertical Data Transaction Timing

Data transaction timing in parallel RGB (24 bit) interface (SYNC mode)

Characteristics	Symbol	Min	Typ	Max	Unit
DOTCLK Frequency	fDOTCLK	-	6.5	10	MHz
DOTCLK Period	tDOTCLK	100	154	-	ns
Horizontal Frequency (Line)	fH	-	14.9	22.35	KHz
Vertical Frequency (Refresh)	fV	-	60	90	Hz
Horizontal Back Porch	tHBP	-	68	-	tDOTCLK
Horizontal Front Porch	tHFP	-	20	-	tDOTCLK
Horizontal Data Start Point	tHBP	-	68	-	tDOTCLK
Horizontal Blanking Period	tHBP + tHFP	-	88	-	tDOTCLK
Horizontal Display Area	H_DISP	-	320	-	tDOTCLK
Horizontal Cycle	H_cycle	-	408	450	tDOTCLK
Vertical Back Porch	tVBP	-	18	-	Lines
Vertical Front Porch	tVFP	-	4	-	Lines
Vertical Data Start Point	tVBP	-	18	-	Lines
Vertical Blanking Period	tVBP + tVFP	-	22	-	Lines
Vertical Display Area	V_DISP	-	240	-	Lines
Vertical Cycle	V_cycle	-	262	350	Lines

Data transaction timing in normal operating mode

Characteristics	Symbol	Min.	Typ.	Max.	Unit
DOTCLK Frequency	fDOTCLK	-	6.5	10	MHz
DOTCLK Period	tDOTCLK	100	154	-	ns
Horizontal Blanking Period	tHBP + tHFP	52	88	180	tDOTCLK
Horizontal Display Area	HDISP	-	320	-	tDOTCLK
Horizontal Cycle	Hcycle	372	408	500	tDOTCLK
Vertical Blanking Period	tVBP + tVFP	2	-	47	Lines
Vertical Display Area	VDISP	-	240	-	Lines
Vertical Cycle	Vcycle	242	-	287	Lines

Data transaction timing in DE only operating mode

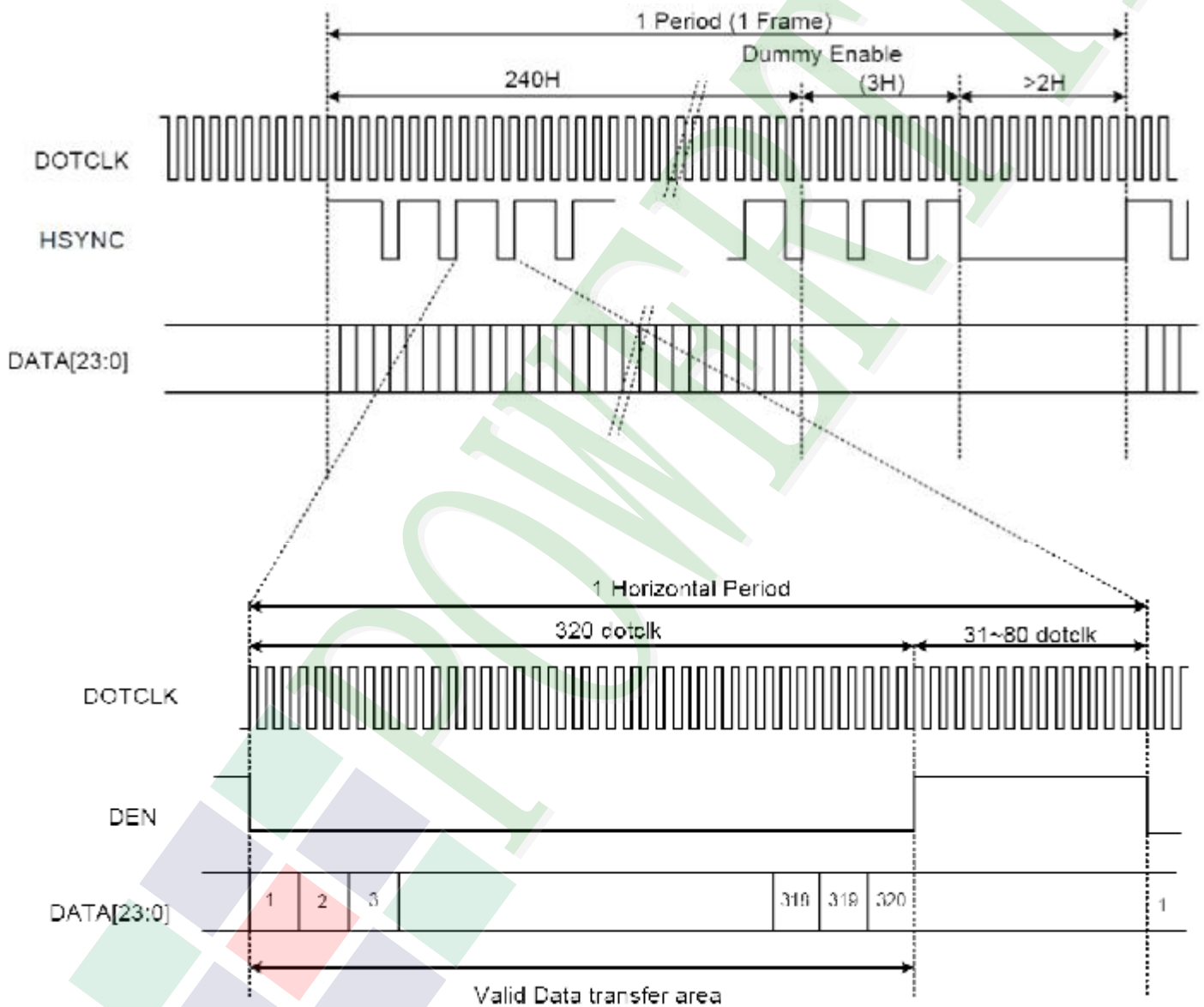

Signal timing in DE mode

2.3.3 SPI Timing Characteristics for HX8238-D

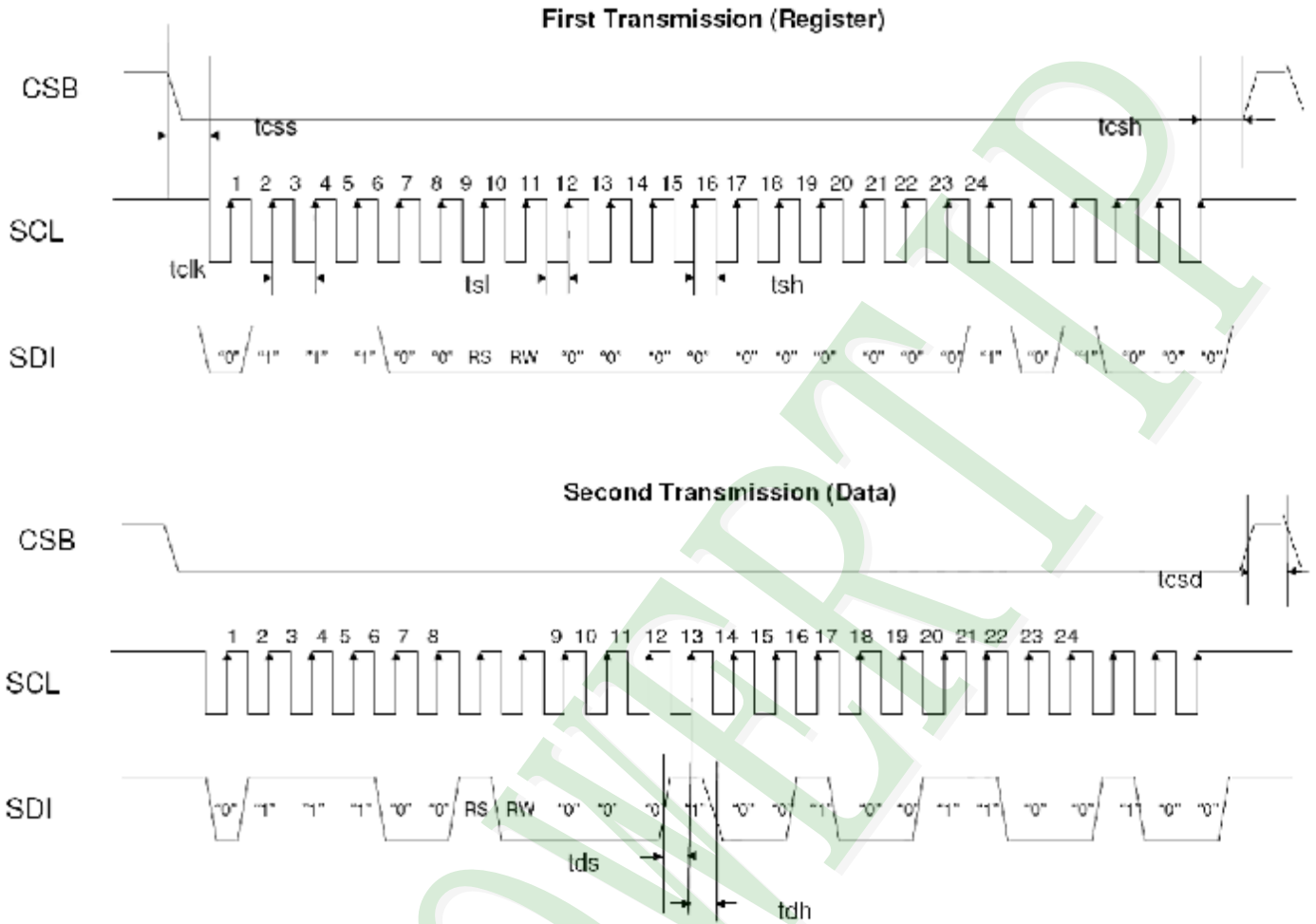

Note: The example transmit "0x1264h" to register R28h.
SPID connected to VSS.

SPI interface timing diagram & transaction example

Characteristics	Symbol	Min	Typ	Max	Unit
Serial Clock Frequency	fcclk	-	-	20	MHz
Serial Clock Cycle Time	tclk	50	-	-	ns
Clock Low Width	tsl	25	-	-	ns
Clock High Width	tsh	25	-	-	ns
Chip Select Setup Time	tcss	0	-	-	ns
Chip Select Hold Time	tcsH	10	-	-	ns
Chip Select High Delay Time	tcsd	20	-	-	ns
Data Setup Time	tds	5	-	-	ns
Data Hold Time	tdh	10	-	-	ns

SPI timing

2.4 Power Sequence

2.4.1 Power up sequence

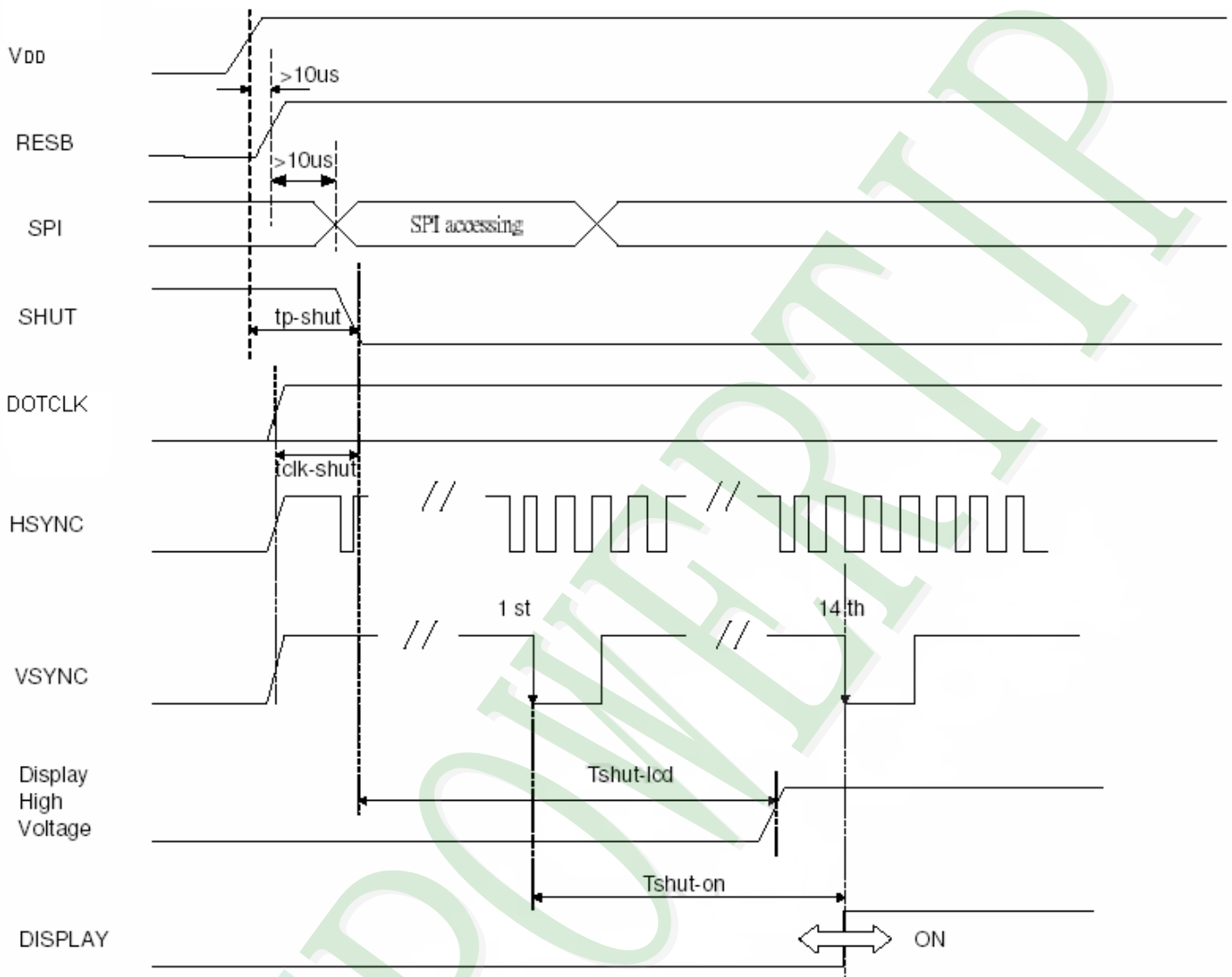

Characteristics	Symbol	Min	Typ	Max	Units
VDD on to falling edge of SHUT	$tp\text{-shut}$	1	-	-	us
DOTCLK	$t\text{clk-shut}$	1	-	-	clk
Falling edge of SHUT to LCD power on	$t\text{shut-lcd}$	-	-	128	ms
Falling edge of SHUT to display start	$t\text{shut-on}$	-	-	14	frame
- 1 line: 408 clk		-	166	232.4	ms
- 1 frame: 262 line - DOTCLK = 6.5MHz		-	-	-	-

Note: It is necessary to input DOTCLK before the falling edge of SHUT.
Display starts at 10th falling edge of VSYNC after the falling edge of SHUT.

Interface PIN No. 48 "Display control" have connected Inverters logic gates to the "SHUT" pin.

2.4.2 Power down sequence

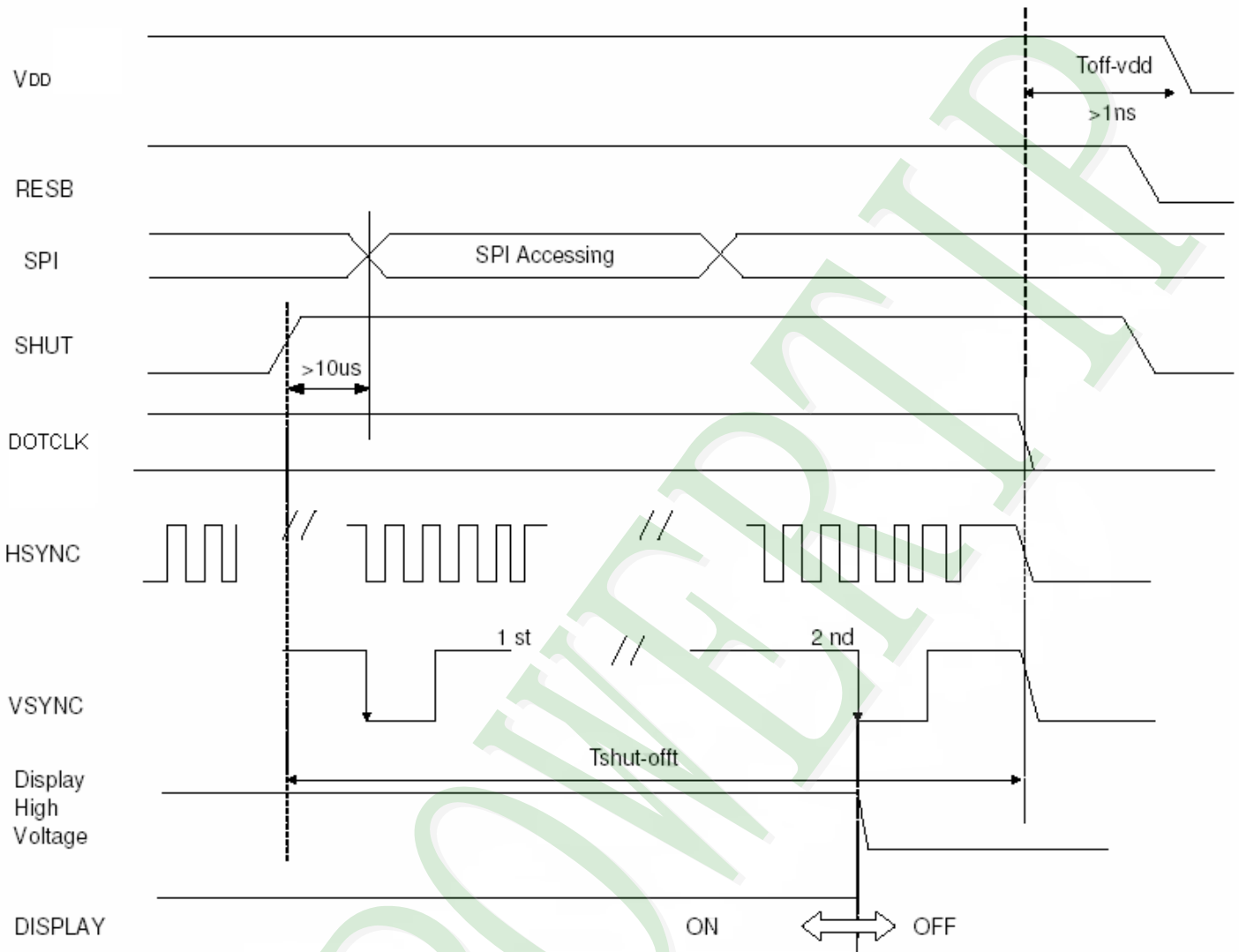

Characteristics	Symbol	Min	Typ	Max	Uni
Rising edge of SHUT to display off	tshut-off	2	-	-	frame
- 1 line: 408 clk		33.4	-	-	ms
- 1 frame: 262 line - DOTCLK = 6.5MHz					
Input-signal-off to VDD off	toff-vdd	1	-	-	us

Note: DOTCLK must be maintained at least 2 frames after the rising edge of SHUT.

Display become off at the 2nd falling edge of VSYNC after the falling edge of SHUT.

If RESET signal is necessary for power down, provide it after the 2-frames-cycle of the SHUT period.

2.4.3 Power Timing Characteristics of Backlight

POWER ON

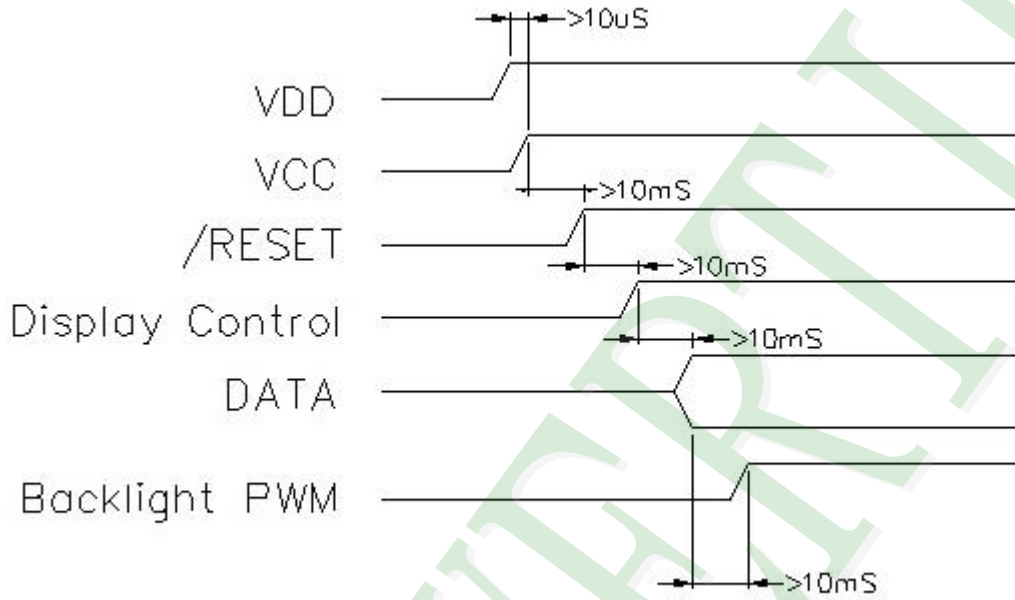

POWER OFF

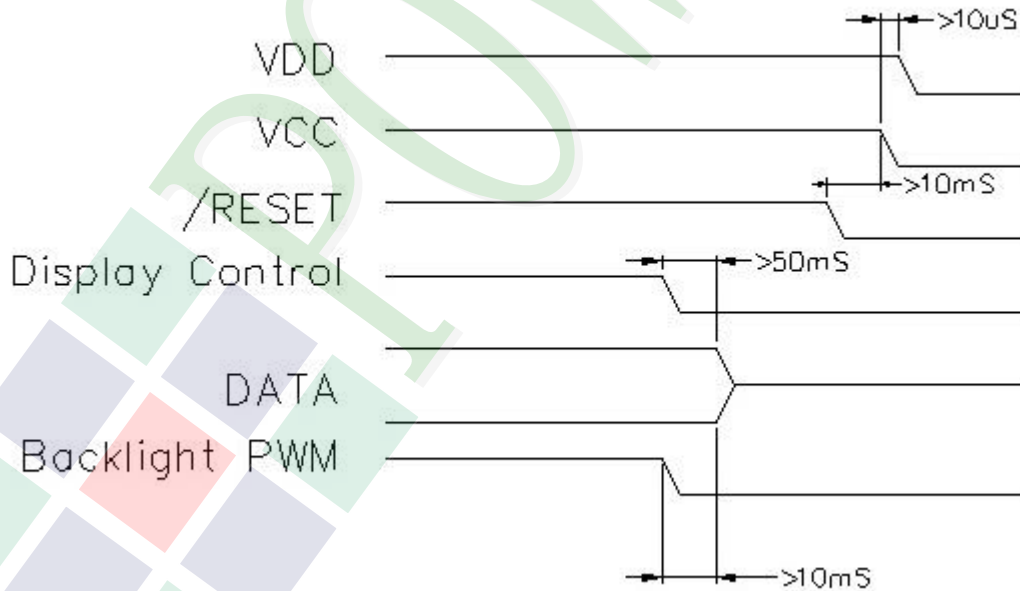

3. QUALITY ASSURANCE SYSTEM

3.1 Quality Assurance Flow Chart

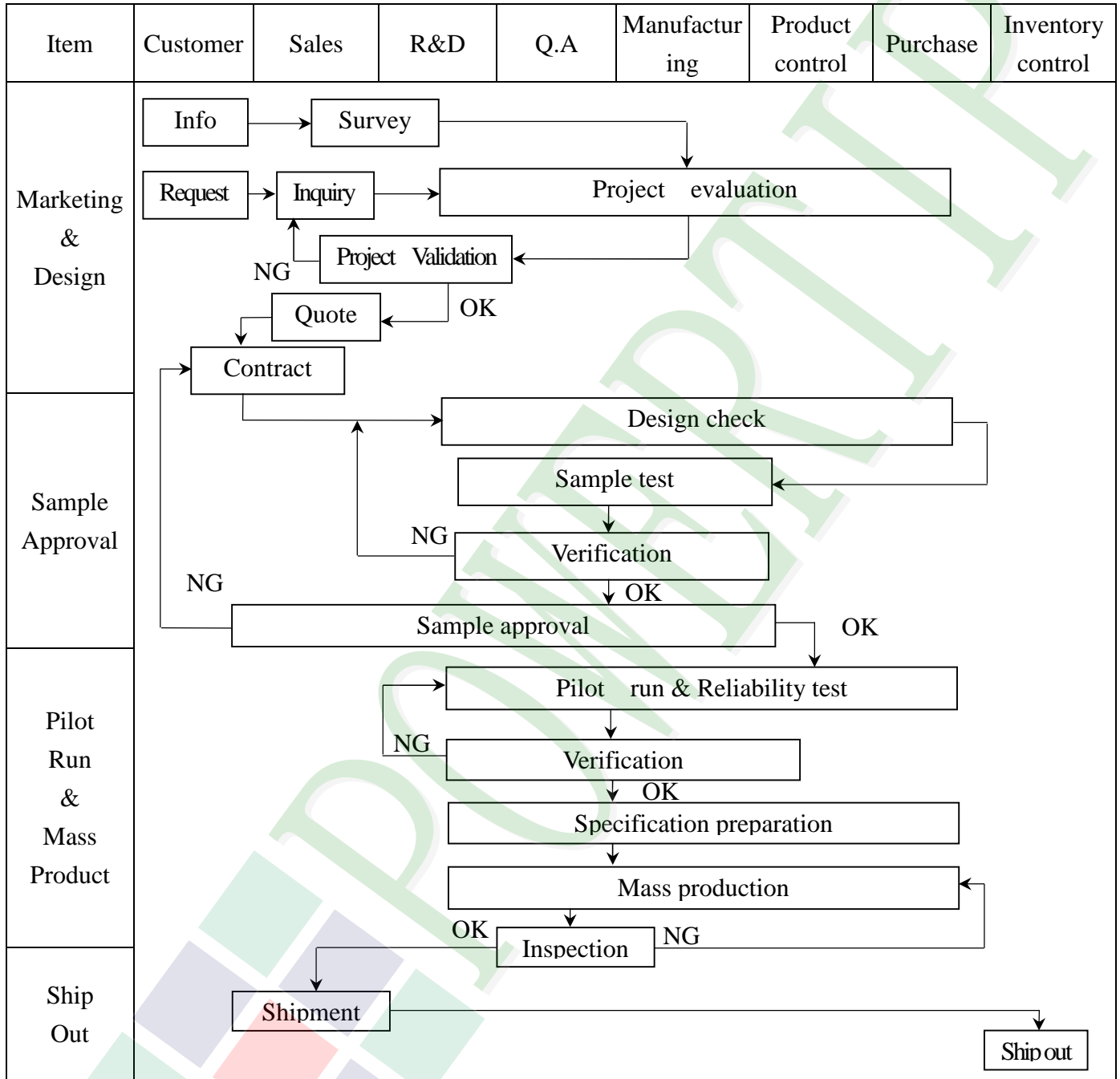

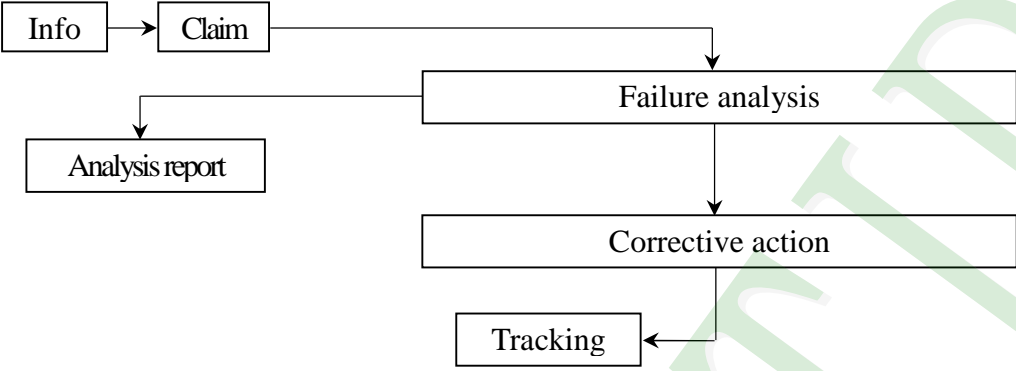
Item	Customer	Sales	R&D	Q.A	Manufacturing	Product control	Purchase	Inventory control
Sales Service	 <pre> graph TD Info[Info] --> Claim[Claim] Claim --> FA[Failure analysis] Claim --> AR[Analysis report] FA --> CA[Corrective action] CA --> Tracking[Tracking] </pre>							
Q.A Activity	1. ISO 9001 Maintenance Activities 3. Equipment calibration 5. Standardization Management				2. Process improvement proposal 4. Education And Training Activities			

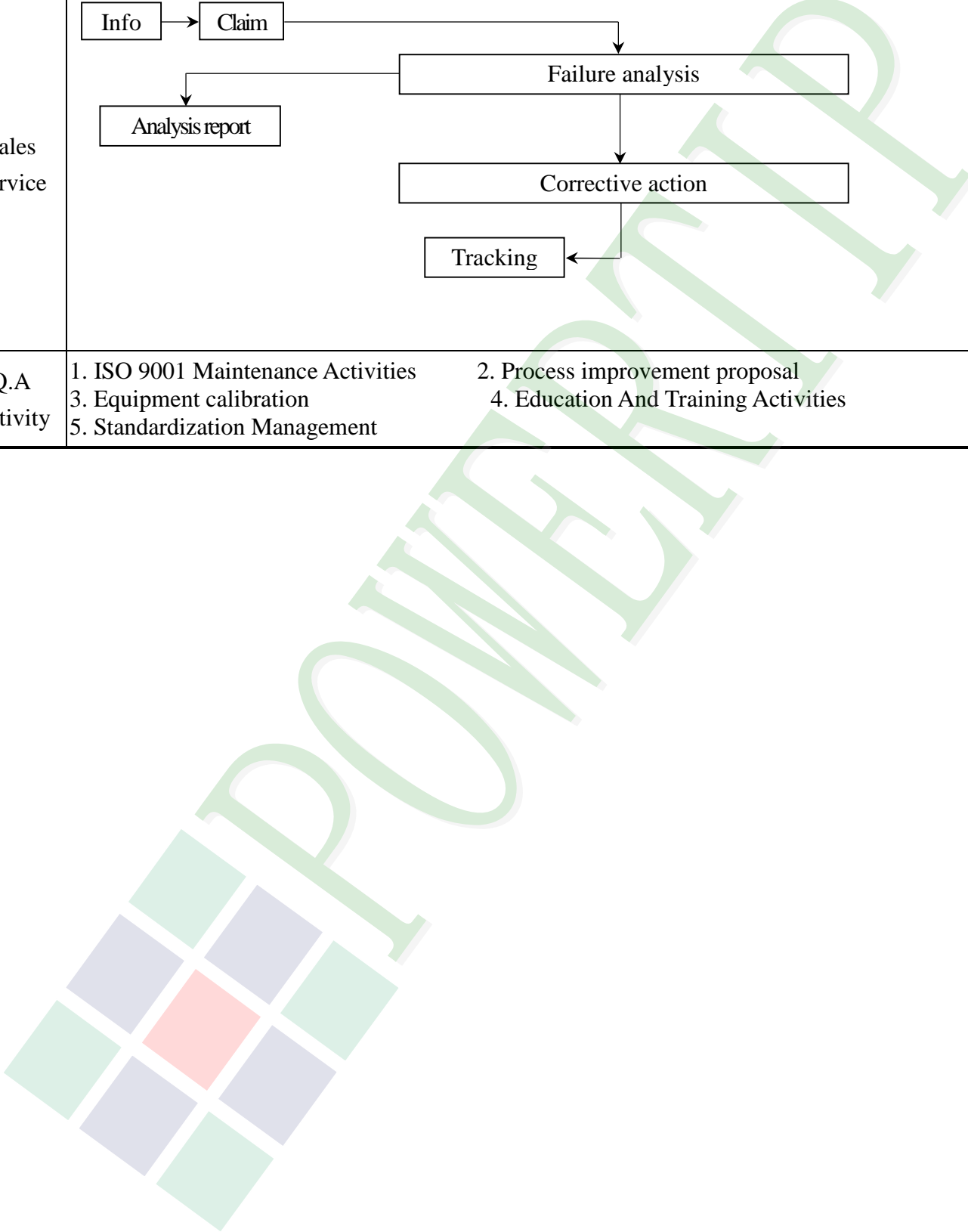

3.2 Inspection Specification

- ◆Scope : The document shall be applied to TFT-LCD Module for 3.5" ~10" (Ver.B01).
- ◆Inspection Standard : MIL-STD-105E Table Normal Inspection Single Sampling Level II.
- ◆Equipment : Gauge 、 MIL-STD 、 Powertip Tester 、 Sample
- ◆Defect Level : Major Defect AQL : 0.4 ; Minor Defect AQL : 1.5
- ◆OUT Going Defect Level : Sampling.
- ◆Standard of the product appearance test :

a. Manner of appearance test :

- (1). The test best be under 20W×2 fluorescent light , and distance of view must be at 30 cm.
- (2). The test direction is base on about around 45° of vertical line.

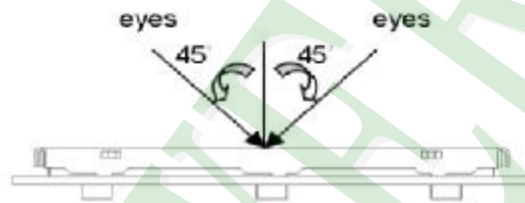

(3). Definition of area.

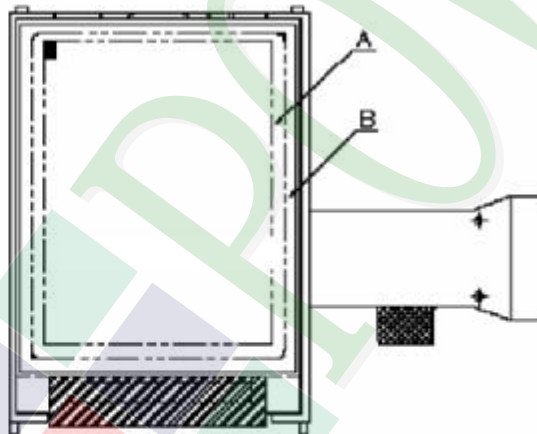

A area : viewing area

B area : Outside of viewing area

(4). Standard of inspection : (Unit : mm)

◆ Specification For TFT-LCD Module 3.5" ~10" :

(Ver.B01)

NO	Item	Criterion	Level										
01	Product condition	1.1 The part number is inconsistent with work order of production.	Major										
		1.2 Mixed product types.	Major										
		1.3 Assembled in inverse direction.	Major										
02	Quantity	2.1 The quantity is inconsistent with work order of production.	Major										
03	Outline dimension	3.1 Product dimension and structure must conform to structure diagram.	Major										
		4.1 Missing line character and icon.	Major										
04	Electrical Testing	4.2 No function or no display.	Major										
		4.3 Display malfunction.	Major										
		4.4 LCD viewing angle defect.	Major										
		4.5 Current consumption exceeds product specifications.	Major										
05	Dot defect (Bright dot , Dark dot) On -display	<table border="1"> <thead> <tr> <th>Item</th> <th>Acceptance (Q'ty)</th> </tr> </thead> <tbody> <tr> <td>Bright Dot</td> <td>≤ 4</td> </tr> <tr> <td>Dark Dot</td> <td>≤ 5</td> </tr> <tr> <td>Joint Dot</td> <td>≤ 3</td> </tr> <tr> <td>Total</td> <td>≤ 7</td> </tr> </tbody> </table>	Item	Acceptance (Q'ty)	Bright Dot	≤ 4	Dark Dot	≤ 5	Joint Dot	≤ 3	Total	≤ 7	Minor
		Item	Acceptance (Q'ty)										
		Bright Dot	≤ 4										
		Dark Dot	≤ 5										
		Joint Dot	≤ 3										
Total	≤ 7												
5.1 Inspection pattern : full white , full black , Red , Green and blue screens.													
5.2 It is defined as dot defect if defect area $> 1/2$ dot.													
5.3 The distance between two dot defect ≥ 5 mm.													

◆ Specification For TFT-LCD Module 3.5" ~10" :

(Ver.B01)

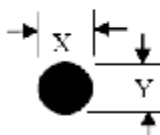
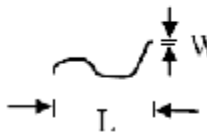
NO	Item	Level																																									
06	<p style="text-align: center;">6.1 Round type (Non-display or display) :</p> <div style="display: flex; justify-content: space-between;"> <div style="width: 30%;"> <p>Black or white dot , scratch , contamination</p> <p>Round type</p>  <p>$\Phi = (x + y) / 2$</p> <p>Line type</p>  </div> <div style="width: 60%;"> <table border="1" style="width: 100%; border-collapse: collapse;"> <thead> <tr> <th rowspan="2">Dimension (diameter : Φ)</th> <th colspan="2">Acceptance (Q'ty)</th> </tr> <tr> <th>A area</th> <th>B area</th> </tr> </thead> <tbody> <tr> <td style="text-align: center;">$\Phi \leq 0.25$</td> <td colspan="2" style="text-align: center;">Ignore</td> </tr> <tr> <td style="text-align: center;">$0.25 < \Phi \leq 0.50$</td> <td style="text-align: center;">5</td> <td rowspan="2" style="text-align: center;">Ignore</td> </tr> <tr> <td style="text-align: center;">$\Phi > 0.50$</td> <td style="text-align: center;">0</td> </tr> <tr> <td style="text-align: center;">Total</td> <td style="text-align: center;">5</td> <td></td> </tr> </tbody> </table> <p style="text-align: center;">6.2 Line type(Non-display or display) :</p> <table border="1" style="width: 100%; border-collapse: collapse;"> <thead> <tr> <th rowspan="2">Length (L)</th> <th rowspan="2">Width (W)</th> <th colspan="2">Acceptance (Q'ty)</th> </tr> <tr> <th>A area</th> <th>B area</th> </tr> </thead> <tbody> <tr> <td style="text-align: center;">---</td> <td style="text-align: center;">$W \leq 0.03$</td> <td colspan="2" style="text-align: center;">Ignore</td> </tr> <tr> <td style="text-align: center;">$L \leq 10.0$</td> <td style="text-align: center;">$0.03 < W \leq 0.05$</td> <td style="text-align: center;">4</td> <td rowspan="2" style="text-align: center;">Ignore</td> </tr> <tr> <td style="text-align: center;">$L \leq 5.0$</td> <td style="text-align: center;">$0.05 < W \leq 0.10$</td> <td style="text-align: center;">2</td> </tr> <tr> <td style="text-align: center;">---</td> <td style="text-align: center;">$W > 0.10$</td> <td colspan="2" style="text-align: center;">As round type</td> </tr> <tr> <td style="text-align: center;">Total</td> <td></td> <td colspan="2" style="text-align: center;">5</td> </tr> </tbody> </table> </div> </div>	Dimension (diameter : Φ)	Acceptance (Q'ty)		A area	B area	$\Phi \leq 0.25$	Ignore		$0.25 < \Phi \leq 0.50$	5	Ignore	$\Phi > 0.50$	0	Total	5		Length (L)	Width (W)	Acceptance (Q'ty)		A area	B area	---	$W \leq 0.03$	Ignore		$L \leq 10.0$	$0.03 < W \leq 0.05$	4	Ignore	$L \leq 5.0$	$0.05 < W \leq 0.10$	2	---	$W > 0.10$	As round type		Total		5		Minor
Dimension (diameter : Φ)	Acceptance (Q'ty)																																										
	A area	B area																																									
$\Phi \leq 0.25$	Ignore																																										
$0.25 < \Phi \leq 0.50$	5	Ignore																																									
$\Phi > 0.50$	0																																										
Total	5																																										
Length (L)	Width (W)	Acceptance (Q'ty)																																									
		A area	B area																																								
---	$W \leq 0.03$	Ignore																																									
$L \leq 10.0$	$0.03 < W \leq 0.05$	4	Ignore																																								
$L \leq 5.0$	$0.05 < W \leq 0.10$	2																																									
---	$W > 0.10$	As round type																																									
Total		5																																									
07	<p>Polarizer Bubble</p> <table border="1" style="width: 100%; border-collapse: collapse;"> <thead> <tr> <th rowspan="2">Dimension (diameter : Φ)</th> <th colspan="2">Acceptance (Q'ty)</th> </tr> <tr> <th>A area</th> <th>B area</th> </tr> </thead> <tbody> <tr> <td style="text-align: center;">$\Phi \leq 0.25$</td> <td colspan="2" style="text-align: center;">Ignore</td> </tr> <tr> <td style="text-align: center;">$0.25 < \Phi \leq 0.50$</td> <td style="text-align: center;">4</td> <td rowspan="2" style="text-align: center;">Ignore</td> </tr> <tr> <td style="text-align: center;">$0.50 < \Phi \leq 0.80$</td> <td style="text-align: center;">1</td> </tr> <tr> <td style="text-align: center;">$\Phi > 0.80$</td> <td style="text-align: center;">0</td> <td></td> </tr> <tr> <td style="text-align: center;">Total</td> <td style="text-align: center;">5</td> <td></td> </tr> </tbody> </table>	Dimension (diameter : Φ)	Acceptance (Q'ty)		A area	B area	$\Phi \leq 0.25$	Ignore		$0.25 < \Phi \leq 0.50$	4	Ignore	$0.50 < \Phi \leq 0.80$	1	$\Phi > 0.80$	0		Total	5		Minor																						
Dimension (diameter : Φ)	Acceptance (Q'ty)																																										
	A area	B area																																									
$\Phi \leq 0.25$	Ignore																																										
$0.25 < \Phi \leq 0.50$	4	Ignore																																									
$0.50 < \Phi \leq 0.80$	1																																										
$\Phi > 0.80$	0																																										
Total	5																																										

◆Specification For TFT-LCD Module 3.5" ~10" :

(Ver.B01)

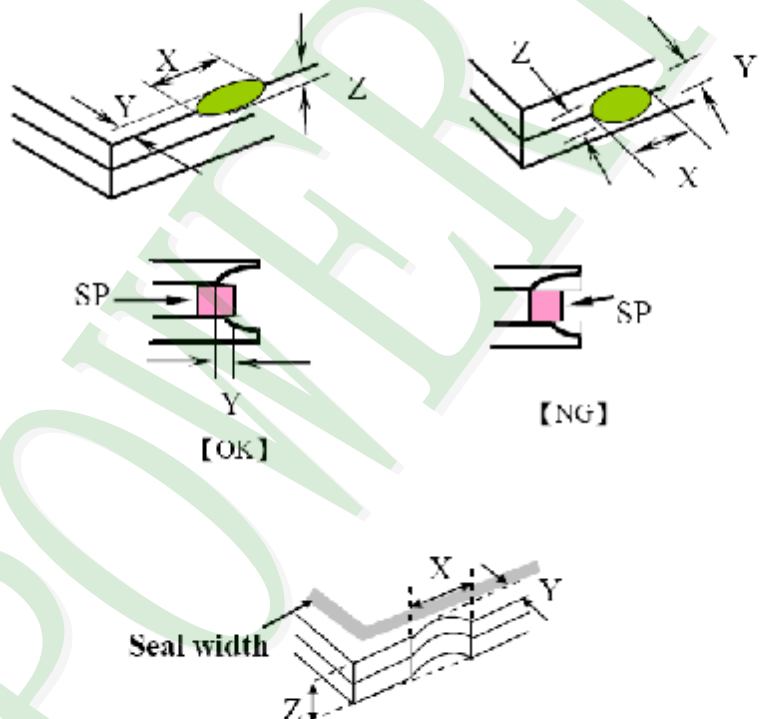
NO	Item	Criterion	Level						
08	The crack of glass	<p>Symbols :</p> <p>X : The length of crack Z : The thickness of crack t : The thickness of glass</p> <p>Y : The width of crack. W : terminal length a : LCD side length</p>	Minor						
		<p>8.1 General glass chip :</p> <p>8.1.1 Chip on panel surface and crack between panels:</p>  <table border="1" data-bbox="542 1568 1340 1859"> <thead> <tr> <th>X</th> <th>Y</th> <th>Z</th> </tr> </thead> <tbody> <tr> <td>$\leq a$</td> <td>Crack can't enter viewing area</td> <td>$\leq 1/2 t$</td> </tr> <tr> <td>$\leq a$</td> <td>Crack can't exceed the half of SP width.</td> <td>$1/2 t < Z \leq 2 t$</td> </tr> </tbody> </table>		X	Y	Z	$\leq a$	Crack can't enter viewing area	$\leq 1/2 t$
X	Y	Z							
$\leq a$	Crack can't enter viewing area	$\leq 1/2 t$							
$\leq a$	Crack can't exceed the half of SP width.	$1/2 t < Z \leq 2 t$							

◆ Specification For TFT-LCD Module 3.5" ~10" :

(Ver.B01)

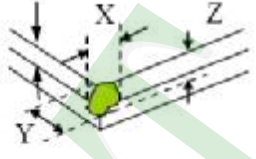
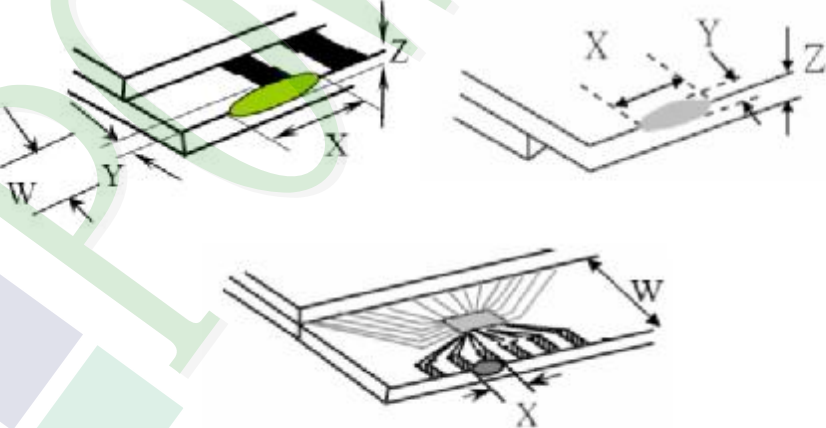
NO	Item	Criterion	Level												
08	The crack of glass	<p>Symbols :</p> <p>X : The length of crack Z : The thickness of crack t : The thickness of glass</p> <p>Y : The width of crack. W : terminal length a : LCD side length</p> <hr/> <p>8.1.2 Corner crack :</p>  <table border="1" data-bbox="523 772 1332 1064"> <thead> <tr> <th>X</th> <th>Y</th> <th>Z</th> </tr> </thead> <tbody> <tr> <td>$\leq 1/5 a$</td> <td>Crack can't enter viewing area</td> <td>$Z \leq 1/2 t$</td> </tr> <tr> <td>$\leq 1/5 a$</td> <td>Crack can't exceed the half of SP width.</td> <td>$1/2 t < Z \leq 2 t$</td> </tr> </tbody> </table>	X	Y	Z	$\leq 1/5 a$	Crack can't enter viewing area	$Z \leq 1/2 t$	$\leq 1/5 a$	Crack can't exceed the half of SP width.	$1/2 t < Z \leq 2 t$				
		X	Y	Z											
$\leq 1/5 a$	Crack can't enter viewing area	$Z \leq 1/2 t$													
$\leq 1/5 a$	Crack can't exceed the half of SP width.	$1/2 t < Z \leq 2 t$													
		<p>8.2 Protrusion over terminal :</p> <p>8.2.1 Chip on electrode pad :</p>  <table border="1" data-bbox="561 1691 1343 1863"> <thead> <tr> <th></th> <th>X</th> <th>Y</th> <th>Z</th> </tr> </thead> <tbody> <tr> <td>Front</td> <td>$\leq a$</td> <td>$\leq 1/2 W$</td> <td>$\leq t$</td> </tr> <tr> <td>Back</td> <td>$\leq a$</td> <td>$\leq W$</td> <td>$\leq 1/2 t$</td> </tr> </tbody> </table>		X	Y	Z	Front	$\leq a$	$\leq 1/2 W$	$\leq t$	Back	$\leq a$	$\leq W$	$\leq 1/2 t$	Minor
	X	Y	Z												
Front	$\leq a$	$\leq 1/2 W$	$\leq t$												
Back	$\leq a$	$\leq W$	$\leq 1/2 t$												

◆ Specification For TFT-LCD Module 3.5" -10" :

(Ver.B01)

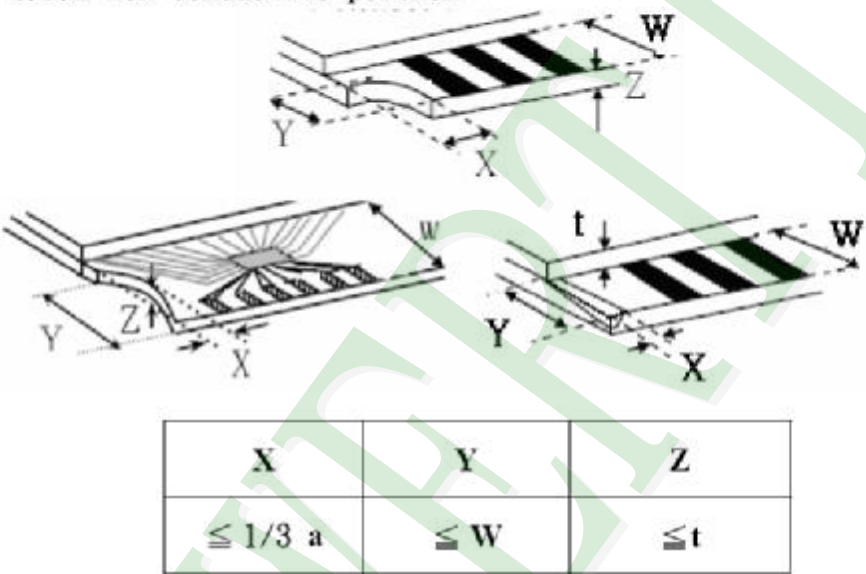
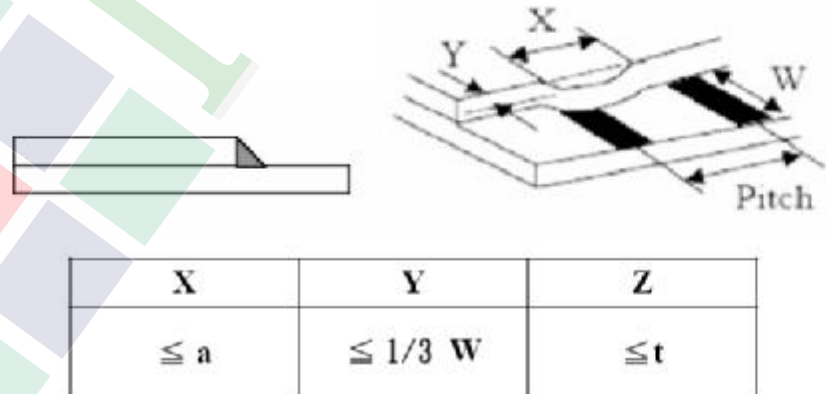
NO	Item	Criterion	Level
08	The crack of glass	<p>Symbols :</p> <p>X : The length of crack Y : The width of crack. Z : The thickness of crack W : terminal length t : The thickness of glass a : LCD side length</p>	Minor
		<p>8.2.2 Non-conductive portion :</p>  <p>⊙ If the chipped area touches the ITO terminal, over 2/3 of the ITO must remain and be inspected according to electrode terminal specifications.</p> <p>8.2.3 Glass remain :</p> 	

◆Specification For TFT-LCD Module 3.5" ~10" :

(Ver.B01)

NO	Item	Criterion	Level
09	Backlight elements	9. 1 Backlight can't work normally.	Major
		9. 2 Backlight doesn't light or color is wrong.	Major
		9. 3 Illumination source flickers when lit.	Major
10	General appearance	10. 1 Pin type 、 quantity 、 dimension must match type in structure diagram.	Major
		10. 2 No short circuits in components on PCB or FPC .	Major
		10. 3 Parts on PCB or FPC must be the same as on the production characteristic chart .There should be no wrong parts , missing parts or excess parts.	Major
		10. 4 Product packaging must the same as specified on packaging specification sheet.	Minor
		10. 5 The folding and pceled off in polarizer are not acceptable.	Minor
		10. 6 The PCB or FPC between B/L assembled distance(PCB or FPC) is ≤ 1.5 mm.	Minor

5. PRECAUTION RELATING PRODUCT HANDLING

5.1 SAFETY

- 5.1.1 If the LCD panel breaks , be careful not to get the liquid crystal to touch your skin.
- 5.1.2 If the liquid crystal touches your skin or clothes , please wash it off immediately by using soap and water.

5.2 HANDLING

- 5.2.1 Avoid any strong mechanical shock which can break the glass.
- 5.2.2 Avoid static electricity which can damage the CMOS LSI—When working with the module , be sure to ground your body and any electrical equipment you may be using.
- 5.2.3 Do not remove the panel or frame from the module.
- 5.2.4 The polarizing plate of the display is very fragile. So , please handle it very carefully, do not touch , push or rub the exposed polarizing with anything harder than an HB pencil lead (glass , tweezers , etc.)
- 5.2.5 Do not wipe the polarizing plate with a dry cloth , as it may easily scratch the surface of plate.
- 5.2.6 Do not touch the display area with bare hands , this will stain the display area.
- 5.2.7 Do not use ketonics solvent & aromatic solvent. Use with a soft cloth soaked with a cleaning naphtha solvent.
- 5.2.8 To control temperature and time of soldering is $320 \pm 10^{\circ}\text{C}$ and 3-5 sec.
- 5.2.9 To avoid liquid (include organic solvent) stained on LCM

5.3 STORAGE

- 5.3.1 Store the panel or module in a dark place where the temperature is $25^{\circ}\text{C} \pm 5^{\circ}\text{C}$ and the humidity is below 65% RH.
- 5.3.2 Do not place the module near organics solvents or corrosive gases.
- 5.3.3 Do not crush , shake , or jolt the module.

5.4 TERMS OF WARRANTY

- 5.4.1 Applicable warrant period
The period is within thirteen months since the date of shipping out under normal using and storage conditions.
- 5.4.2 Unaccepted responsibility
This product has been manufactured to your company's specification as a part for use in your company's general electronic products. It is guaranteed to perform according to delivery specifications. For any other use apart from general electronic equipment, we cannot take responsibility if the product is used in nuclear power control equipment, aerospace equipment , fire and security systems or any other applications in which there is a direct risk to human life and where extremely high levels of reliability are required.

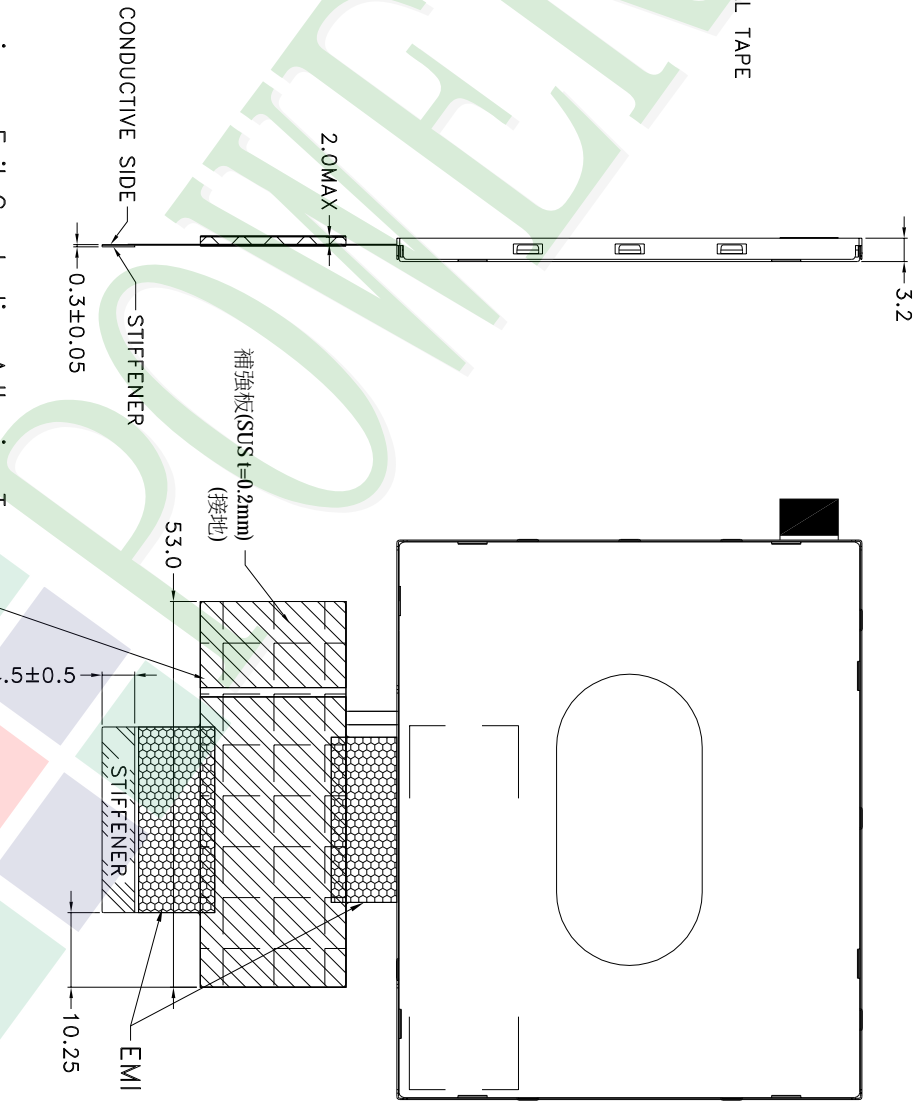
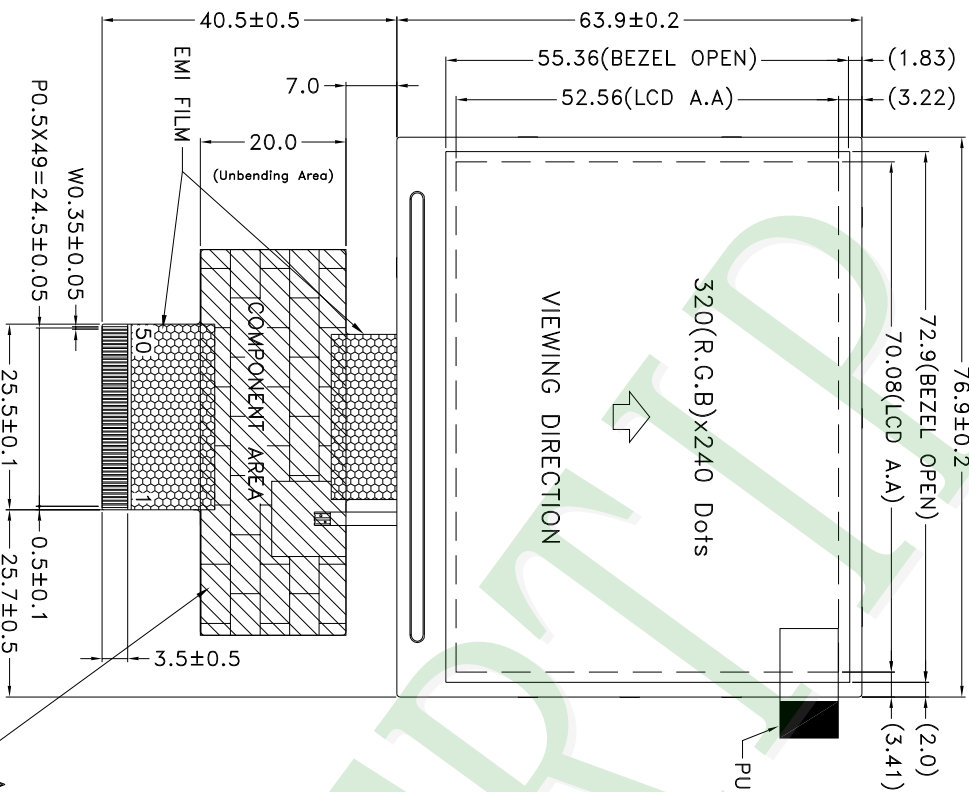

- NOTES:
- LCD TYPE: a-Si TFT
 - LCD DISPLAY: POSITIVE / TRANSMISSIVE
 - The tolerance unless classified $\pm 0.2\text{mm}$
 - FPC Connector: Kyocera 08 6282 050 340 829+ or EQUIVALENT

007		PART NO:	PH320240T023-IHA	<p>久正光电股份有限公司 POWER TIP TECHNOLOGY CORPORATION</p>	Design	Terry	(3) Surface Material Thickness Quantity	Precision Level 1 ~ 4 4 ~ 16 16 ~ 63 63 ~ 250 250 ~ 1000
006		DRAWING NAME:	JLMD-PH320240T023-IHA		Check	Eddy		
005		TITLE:	LCD MODULE DRAWING		Approve	Ryan		
004					Unit	MM		
003				Scale	FIT	Material	1 ~ 4	
002				Page	1/2	Thickness	4 ~ 16	
001	NEW DRAWING	REV BY	Terry	DATE	2016/01/22	Quantity	16 ~ 63	
REV			REVISER				63 ~ 250	
							250 ~ 1000	

1. 包裝材料規格表 (Packaging Material) : (per carton)

No.	Item	Model	Dimensions (mm)	1Pcs Weight	Quantity	Total Weight
1	成品 (LCM)	PH320240T023-IHA	76.9 X 63.9 X 3.2	0.0324	252	8.1648
2	多層薄膜(1)POF	OTFILM0BA03ABA	19"X350X0.015	—	6	—
3	TRAY 盤 (2)Tray	TYPH32024002BB	352 X 260 X 12.8	0.1	48	4.8
4	內盒(3)Product Box	BX36627063ABBA	393 X 274 X 68	0.182	6	1.092
5	保利龍板(4)Polylon board	OTPLB00PL08ABA	550 X 393 X 20	0.0284	2	0.0568
6	外紙箱(5)Carton	BX57041027CCBA	570 X 410 X 265	1.0	1	1.0
7						
8						
9						

2. 一整箱總重量 (Total LCD Weight in carton) : 15.11 Kg±10%

3. 單箱數量規格表 (Packaging Specifications and Quantity) :

(1) LCM quantity per box : no per tray	6	x no of tray	7	=	42
(2) Total LCM quantity in carton : quantity per box	42	x no of boxes	6	=	252

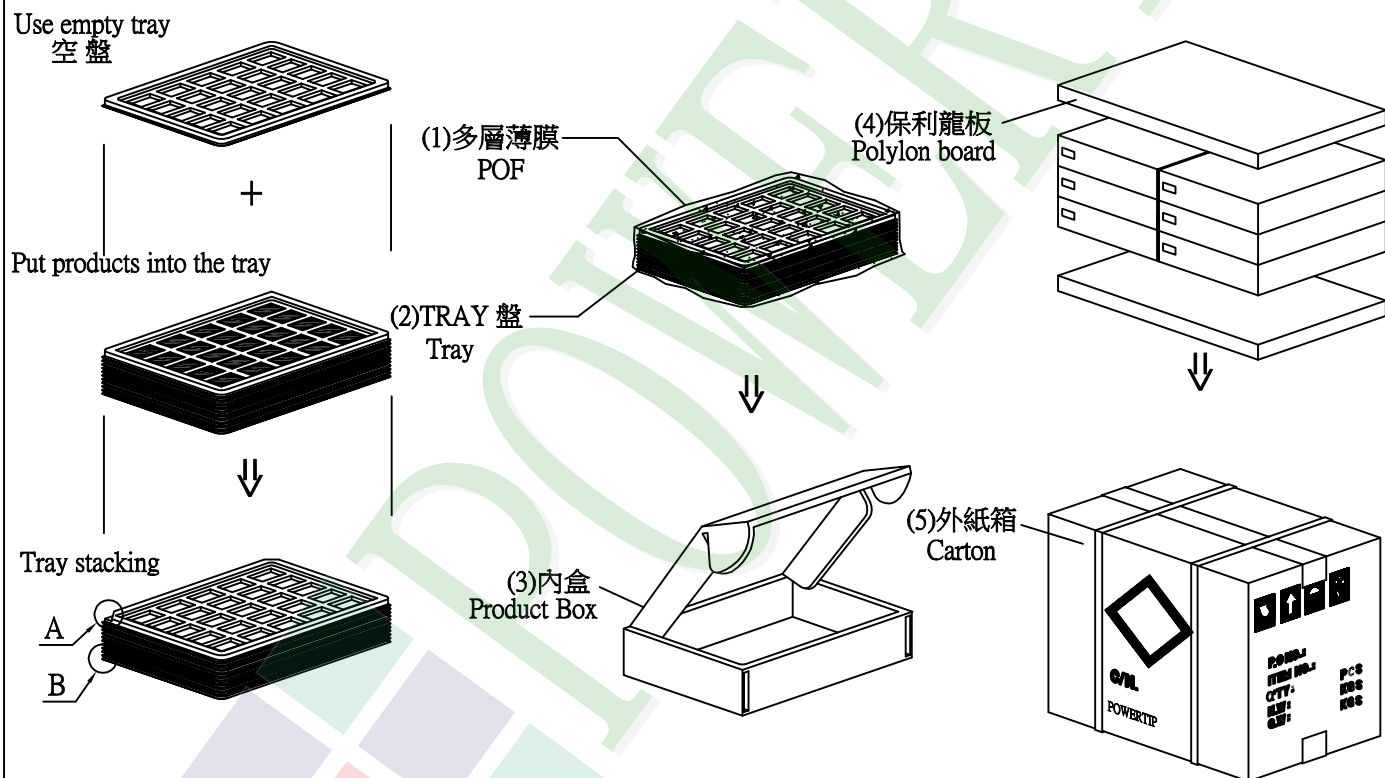

特 記 事 項 (REMARK)

4. Label Specifications :
依廠內標準作業

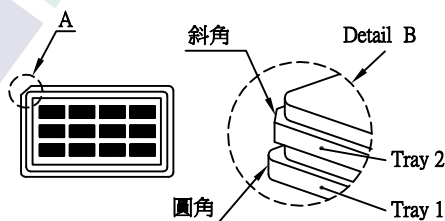

5. TRAY盤相疊時, 需旋轉180度, 請詳見B視圖
Rotate tray 180 degrees and place on top of stack.
Check the tray stack using Fig. B.