



## SPECIFICATIONS

CUSTOMER	:	PTC
SAMPLE CODE	:	SH480272T-005-I11Q
MASS PRODUCTION CODE	:	PH480272T-005-I11Q
SAMPLE VERSION	:	01
SPECIFICATIONS EDITION	:	002
DRAWING NO. (Ver.)	:	LMD- PH480272T-005-I11Q (Ver.002)
PACKAGING NO. (Ver.)	:	PKG- PH480272T-005-I11Q (Ver.001)

**Customer Approved**

---

Date:

Approved	Checked	Designer
廖志豪 Rex Liao	李厚憲 Sam Lee	黃俊清 Ackey Huang

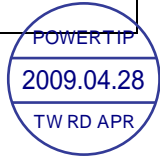

- Preliminary specification for design input
- Specification for sample approval

### POWERTIP TECH. CORP.

**Headquarters:**  
 No.8, 6<sup>th</sup> Road, Taichung Industrial Park,  
 Taichung, Taiwan  
 台中市 407 工業區六路 8 號

TEL: 886-4-2355-8168  
 FAX: 886-4-2355-8166

E-mail: [sales@powertip.com.tw](mailto:sales@powertip.com.tw)  
 Http://www.powertip.com.tw



## History of Version

Date (mm / dd / yyyy)	Ver.	Edi.	Description	Page	Design by
03/31/2009	01	001	New Drawing.	-	Ackey
04/27/2009	01	002	New Sample and Modify FPC of T/P.	Appendix	Ackey

Total: 31 Page

## Contents

### 1. SPECIFICATIONS

- 1.1 Features
- 1.2 Mechanical Specifications
- 1.3 Absolute Maximum Ratings
- 1.4 DC Electrical Characteristics
- 1.5 Optical Characteristics
- 1.6 Backlight Characteristics
- 1.7 Touch Panel Characteristics

### 2. MODULE STRUCTURE

- 2.1 Counter Drawing
- 2.2 Interface Pin Description
- 2.3 Timing Characteristics
  - 2.3.1 SPI Write
  - 2.3.2 SPI Timing Table
- 2.4 Color Data Assignment
- 2.5 Reference Initial code

### 3. QUALITY ASSURANCE SYSTEM

- 3.1 Quality Assurance Flow Chart
- 3.2 Inspection Specification

### 4. RELIABILITY TEST

- 4.1 Reliability Test Condition

### 5. PRECAUTION RELATING PRODUCT HANDLING

- 5.1 Safety
- 5.2 Handling
- 5.3 Storage
- 5.4 Terms of Warranty

Appendix : LCM Drawing

LCM Packaging Specifications

Note : For detailed information please refer to IC data sheet :

Primacy(TFT LCD): Himax: HX8257-A

## 1. SPECIFICATIONS

### 1.1 Features

Item	Standard Value
Display Type	480 * 3 (RGB) * 272 Dots
LCD Type	a-Si TFT , Normally white , Transmissive type
Screen size(inch)	4.3 inch
Viewing Direction	6 O'clock
Color configuration	RGB-Strip
Backlight Type	LED B/L
Interface	Digital 24-bits RGB
Other(controller/driver IC)	HX8257-A (Or Compatible IC )
ROHS	THIS PRODUCT CONFORMS THE ROHS OF PTC Detail information please refer web side : <a href="http://www.powertip.com.tw/news/LatestNews.asp">http://www.powertip.com.tw/news/LatestNews.asp</a>

### 1.2 Mechanical Specifications

Item	Standard Value	Unit
Outline Dimension	105.5(W) x 67.2 (L) x 5.0(H)MAX	mm

#### LCD panel

Item	Standard Value	Unit
Viewing Area	96.64 (W) x 55.456 (H)	mm
Active Area	95.04 (W) x 53.856 (L)	mm

#### Touch panel

Item	Standard Value	Unit
Viewing Area	99.5 (W) * 58.0 (L)	mm
Active Area	97.0 (W) * 55.8 (L)	mm

Note : For detailed information please refer to LCM drawing

### 1.3 Absolute Maximum Ratings

#### Module

Item	Symbol	Condition	Min.	Max.	Unit
System Power Supply Voltage	VDDIO	GND=0	-0.3	4.0	V
	VGH-VGL	GND=0	-0.3	45.0	
Input Voltage*1	VI	-	-0.3	VDDIO+0.3	V
Operating Temperature	T <sub>OP</sub>	-	-20	70	°C
Storage Temperature	T <sub>ST</sub>	-	-30	80	°C

\*1: PCLK, R0 ~ R7, G0 ~ G7, B0 ~ B7, Hsync, Vsync, DISP

### 1.4 DC Electrical Characteristics

#### Module

GND = 0V, Ta = 25°C

Item	Symbol	Condition	Min.	Typ.	Max.	Unit
Power Supply Voltage	VDDIO	-	3.0	3.3	3.6	V
Input H/L Level Voltage	VIH	-	0.8VDDIO	-	VDDIO	V
	VIL	-	0	-	0.2VDDIO	V
Supply Current	I <sub>DDIO</sub>	VDDIO = 3.3 V Pattern= Pattern display	-	14	-	mA
		VDDIO = 3.3 V Pattern= black *1	-	16	24	mA

Note1: Maximum current display

## 1.5 Optical Characteristics

### TFT LCD Module

VDDIO= 3.3 V, Ta=25°C

Item		Symbol	Condition	Min.	Typ.	Max.	unit	
Response time	Tr+Tf	25	-		36	54	ms	
Viewing angle	Top	$\theta Y+$	CR $\geq$ 10	-	45	-	Deg.	Note 4
	Bottom	$\theta Y-$		-	50	-		
	Left	$\theta X-$		-	50	-		
	Right	$\theta X+$		-	50	-		
Contrast ratio		CR		200	250	-		Note 3
Color of CIE Coordinate (With B/L)	White	X	Ta = 25°C $\theta X, \theta Y = 0^\circ$	0.28	0.33	0.38	-	Note1
		Y		0.31	0.36	0.41		
	Red	X		0.57	0.62	0.67		
		Y		0.30	0.35	0.40		
	Green	X		0.30	0.35	0.40		
		Y		0.53	0.58	0.63		
	Blue	X		0.10	0.15	0.20		
		Y		0.08	0.13	0.18		
Average Brightness Pattern=white display (With LCD)*1		IV	IF= 20 mA	280	340	-	cd/m <sup>2</sup>	Note1
Uniformity (With LCD)*2		$\Delta B$	IF= 20 mA	70	-	-	%	Note1

Note 1:

\*1 :  $\Delta B = B(\min) / B(\max) * 100\%$

\*2 : Measurement Condition for Optical Characteristics:

a : Environment: **25 ± 5** / **60±20%**R.H , no wind , dark room below **10** Lux at typical lamp current and typical operating frequency.

b : Measurement Distance: **500 ± 50** mm , ( $\theta = 0^\circ$ )

c : Equipment: **TOPCON BM-7 fast** , (field  $1^\circ$ ) , after **10** minutes operation.

d : The uncertainty of the C.I.E coordinate measurement  $\pm 0.01$  , Average Brightness  $\pm 4\%$

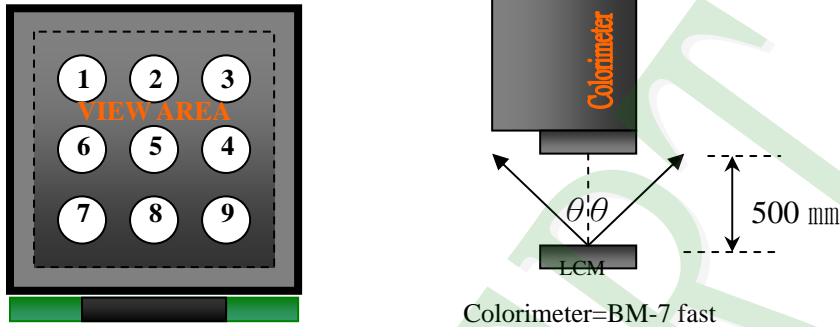

To be measured at the center area of panel with a viewing cone of  $1^\circ$  by Topcon luminance meter BM-7, after 10 minutes operation (module)

Note2: Definition of response time:

The output signals of photo detector are measured when the input signals are changed from "black" to "white"(falling time) and from "white" to "black"(rising time), respectively. The response time is defined as the time interval between the 10% and 90% of Amplitudes.

Refer to figure as below:

Normally White



### Normally Black

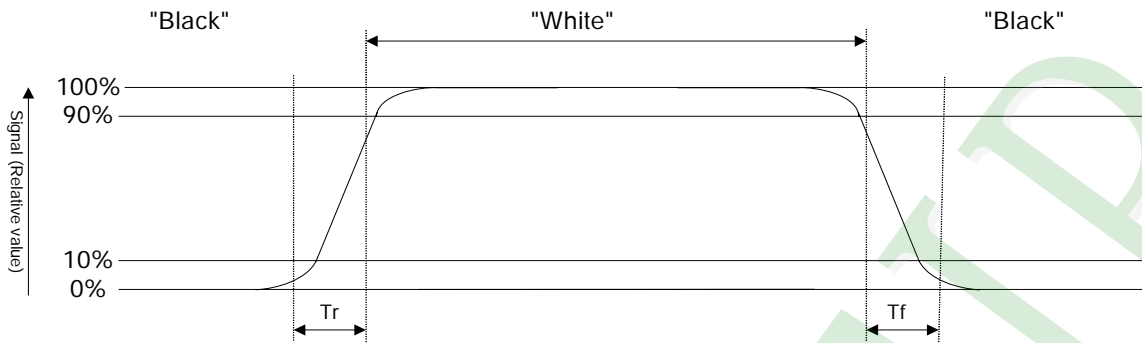

Note3: Definition of contrast ratio:

Contrast ratio is calculated with the following formula

$$\text{Contrast ratio (CR)} = \frac{\text{Photo detector output when LCD is at "White" state}}{\text{Photo detector output when LCD is at "Black" state}}$$

Note4: Definition of viewing angle:

Refer to figure as below:

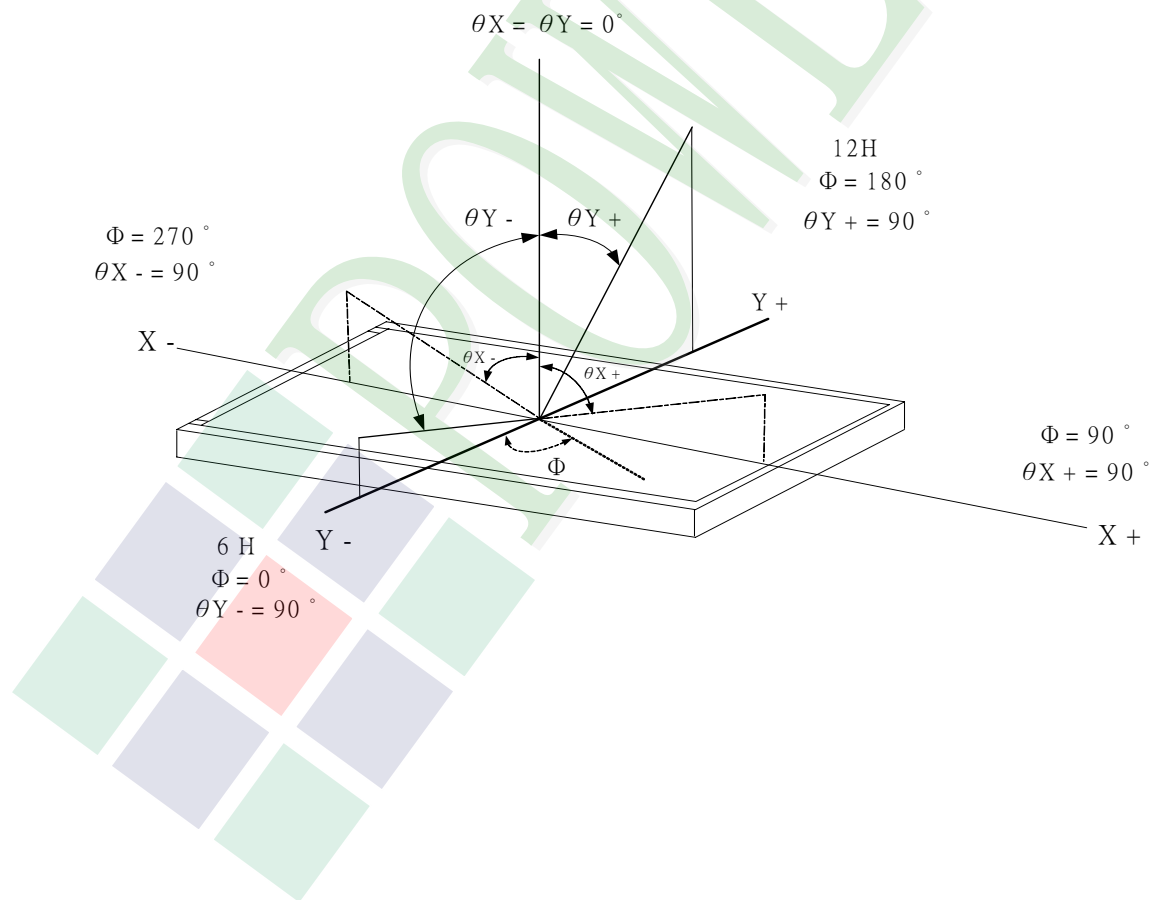



## 1.6 Backlight Characteristics

### Maximum Ratings

Item	Symbol	Conditions	Min.	Max.	Unit
LED Forward Current	IF	Ta =25°C	—	25	mA
LED Reverse Voltage	VR	Ta =25°C	—	5	V
Power Dissipation	PD	Ta =25°C	—	525	mW

### Electrical / Optical Characteristics

Item	Symbol	Conditions	Min.	Typ.	Max.	Unit
Forward Voltage	VF	IF= 20 mA	—	22.8	—	V
Average Brightness (Without LCD &T/P)	IV		3850	4250	—	cd/m <sup>2</sup>
CIE Color Coordinate (Without LCD &T/P)	X		—	0.315	—	—
	Y		—	0.312	—	
Color	White					

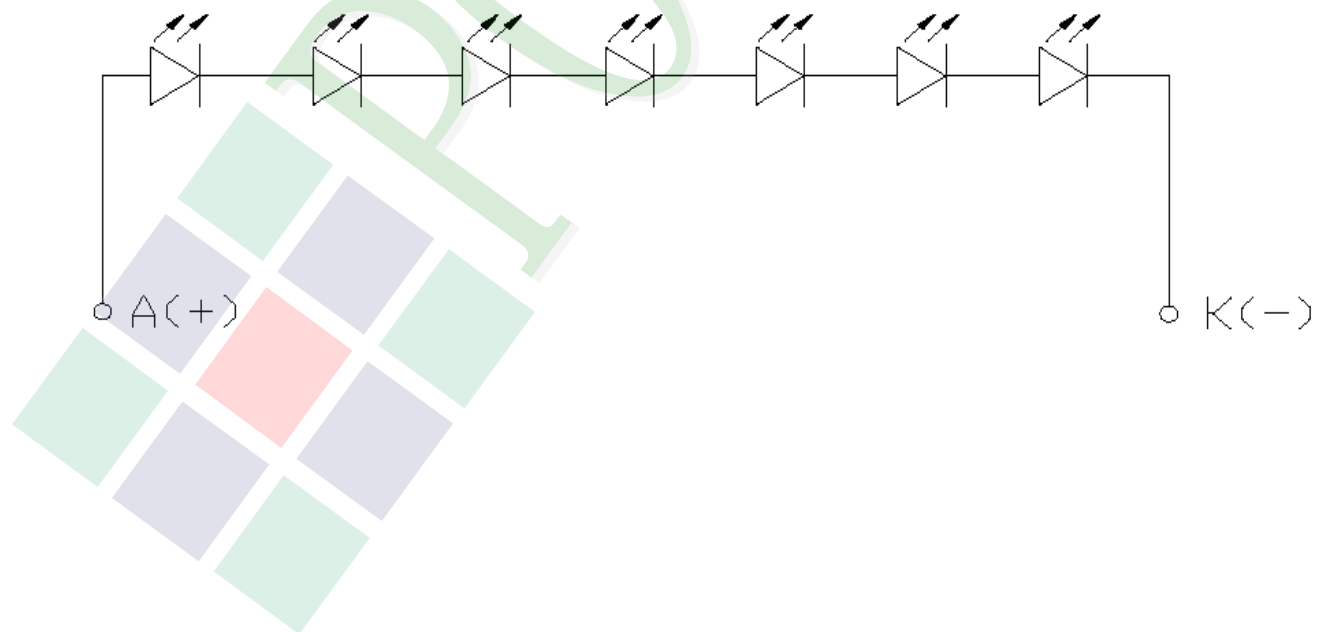

## 1.7 Touch Panel Characteristics

Item	Specification
Input Method	Finger or stylus pen.
ITO Glass	T=0.7mm , 500Ω/□ ±150 Ω
ITO Film	T=0.188mm , 450Ω/□ ±150 Ω Anti-Glare Type
Operating Temperature	-20 ~40 ,90%RH↓,41 ~75 ,60%RH↓(Except for dew gathering.)
Storage Temperature	-40 ~40 ,90%RH↓,41 ~85 ,60%RH↓(Except for dew gathering.)
Surface Hardness	2H- pressure 500gf , 45deg.
Hitting Durability	1,000,000 times min. (Tip R 8 mm & R0.8mm)
Pen Sliding Durability	100,000 times min. (Tip R0.8mm)
Insulation Impedance	DC25V 1min,20MΩ↑
Light Transparency	80%min.
Linearity	±1.5% (±1.5% After environmental and life test)
Linearity Force	130gf less input with stylus pen (R0.8mm)
Activation Force	80gf(Typical 20gf) less individual point on with stylus pen(R0.8mm).
Bouncing	<10ms
Impact Resistance	No damage when φ9mm steel ball is dropped on the surface from 30 cm height at 1 time.
Flexible Pattern Heat Seal Peeling Strength	500gf/cm ( peeling upward by 90 deg.)
Flexible Pattern Bending Resistance	Bending 3 times by bending radius R1.0 mm. The requirements in 4-2 shall be satisfied
Flexible Pattern Insert/Pull Out Resistance	1times at least. The requirements in 4-2 shall be satisfied.
Vibration Resistance	Not in operation: The requirements in 3 to 4 shall be satisfied after sweep vibration of 2G 15~55Hz(1 min.) is given for 30 min. each in the directions of X, Y, Z.
Package Drop	No damage to the product.(1corner edge, 2 ridges, 4 surfaces, drop from 50 cm height)
Static load resistance	After 4.5Kg load for 1 min is applied to the center area(1.0cm <sup>2</sup> )of the Touch panel, the requirements in 3 and 4,shall be satisfied.

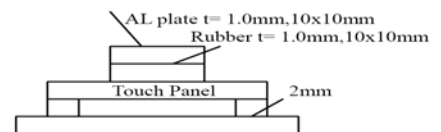

## 2. MODULE STRUCTURE

### 2.1 Counter Drawing

#### 2.1.1 LCM Mechanical Diagram

\* See Appendix

#### 2.1.2 Block Diagram

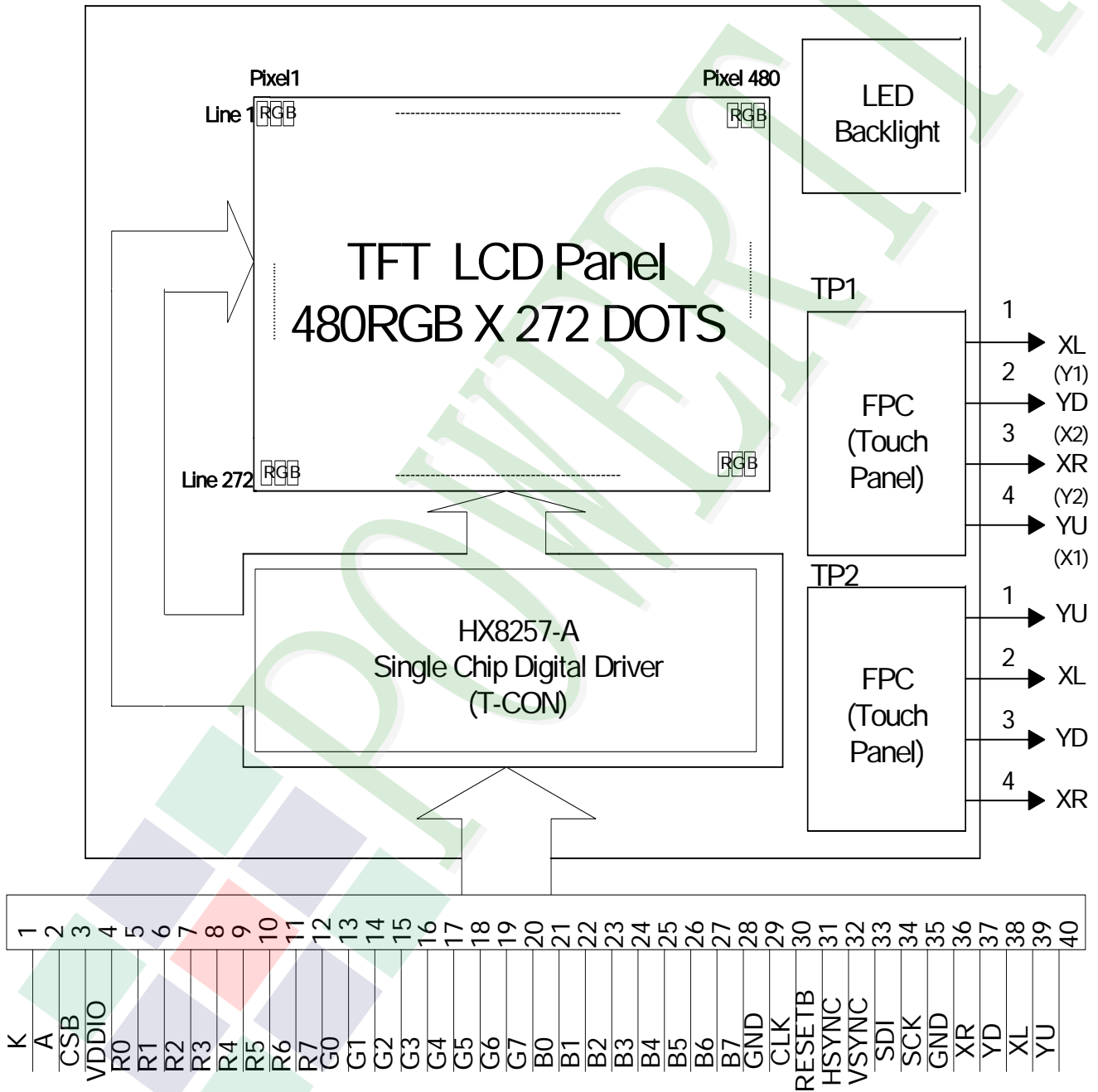

## 2.2 Interface Pin Description

Pin No.	Symbol	Function
1	K	Power supply for LED Backlight cathode input
2	A	Power supply for LED Backlight anode input
3	CSB	Chip select pin of serial interface.
4	VDDIO	Digital power
5	R0	Red data bit 0
6	R1	Red data bit 1
7	R2	Red data bit 2
8	R3	Red data bit 3
9	R4	Red data bit 4
10	R5	Red data bit 5
11	R6	Red data bit 6
12	R7	Red data bit 7
13	G0	Green data bit 0
14	G1	Green data bit 1
15	G2	Green data bit 2
16	G3	Green data bit 3
17	G4	Green data bit 4
18	G5	Green data bit 5
19	G6	Green data bit 6
20	G7	Green data bit 7

Pin No.	Symbol	Function
21	B0	Blue data bit 0
22	B1	Blue data bit 1
23	B2	Blue data bit 2
24	B3	Blue data bit 3
25	B4	Blue data bit 4
26	B5	Blue data bit 5
27	B6	Blue data bit 6
28	B7	Blue data bit 7
29	GND	Ground
30	CLK	Dot data clock
31	RESETB	Active low global reset signal input.
32	HSYNC	Horizontal sync input
33	VSYNC	Vertical sync input
34	SDI	Data input pin in serial interface.
35	SCL	Clock input pin in serial interface.
36	GND	Ground
37	XR	Right side of touch panel.
38	YD	Bottom side of touch panel.
39	XL	Left side of touch panel.
40	YU	Up side of touch panel.

## 2.3 Timing Characteristics

### Timing Parameters 1

(480RGBx272, T<sub>A</sub>=25°C, VDDIO=1.8V to 3.6V, GND= 0V)

Parameter	Symbol	Spec.			Unit
		Min.	Typ.	Max.	
Clock cycle	f <sub>CLK</sub> <sup>(1)</sup>	-	9	15	MHz
Hsync cycle	1/th	-	17.14	-	KHz
Vsync cycle	1/tv	-	59.94	-	Hz
Horizontal Signal					
Horizontal cycle	th	525	525	605	CLK
Horizontal display period	thd	480	480	480	CLK
Horizontal front porch	thf	2	2	82	CLK
Horizontal pulse width	thp <sup>(2)</sup>	2	41	41	CLK
Horizontal back porch	thb <sup>(2)</sup>	2	2	41	CLK
Vertical Signal					
Vertical cycle	tv	285	286	511	H <sup>(1)</sup>
Vertical display period	tvd	272	272	272	H <sup>(1)</sup>
Vertical front porch	tvf	1	2	227	H <sup>(1)</sup>
Vertical pulse width	tvp <sup>(2)</sup>	1	10	11	H <sup>(1)</sup>
Vertical back porch	tvb <sup>(2)</sup>	1	2	11	H <sup>(1)</sup>

Note: (1) Unit: CLK=1/ f<sub>CLK</sub>, H=th,

(2) It is necessary to keep tvp+tvb=12 and thp+thb=43 in sync mode. DE mode is unnecessary to keep it.

## Timing Chart 1

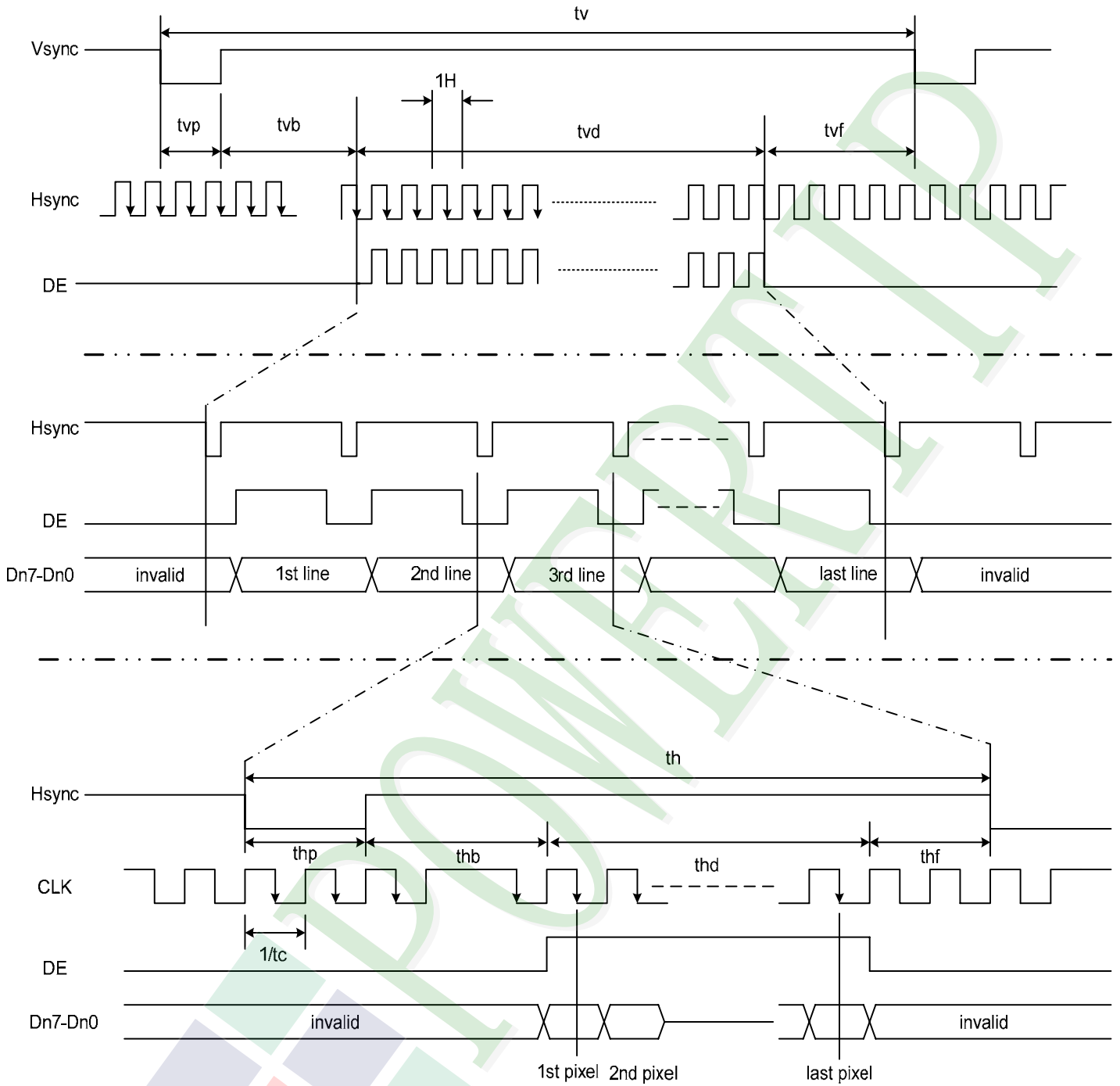

## Timing Parameters 2

( $T_A=25^\circ\text{C}$ ,  $V_{DDIO}=1.8\text{V to }3.6\text{V}$ ,  $t_r^{(1)}=t_f^{(1)}=2\text{ns}$ )

Parameter	Symbol	Spec.			Unit
		Min.	Typ.	Max.	
DISP setup time	$t_{diss}$	10	-	-	ns
DISP hold time	$t_{dish}$	10	-	-	ns
Clock period	$PW_{CLK}^{(2)}$	66.7	-	-	ns
Clock pulse high period	$PWH^{(2)}$	26.7	-	-	ns
Clock pulse low period	$PWL^{(2)}$	26.7	-	-	ns
Hsync setup time	$t_{hs}$	10	-	-	ns
Hsync hold time	$t_{hh}$	10	-	-	ns
Data setup time	$t_{ds}$	10	-	-	ns
Data hold time	$t_{dh}$	10	-	-	ns
DE setup time	$t_{des}$	10	-	-	ns
DE hold time	$t_{deh}$	10	-	-	ns
Vsync setup time	$t_{vhs}$	10	-	-	ns
Vsync hold time	$t_{vhh}$	10	-	-	ns

Note: (1)  $t_r$ ,  $t_f$  is defined 10% to 90% of signal amplitude.

(2) For parallel interface, maximum clock frequency is 15MHz.

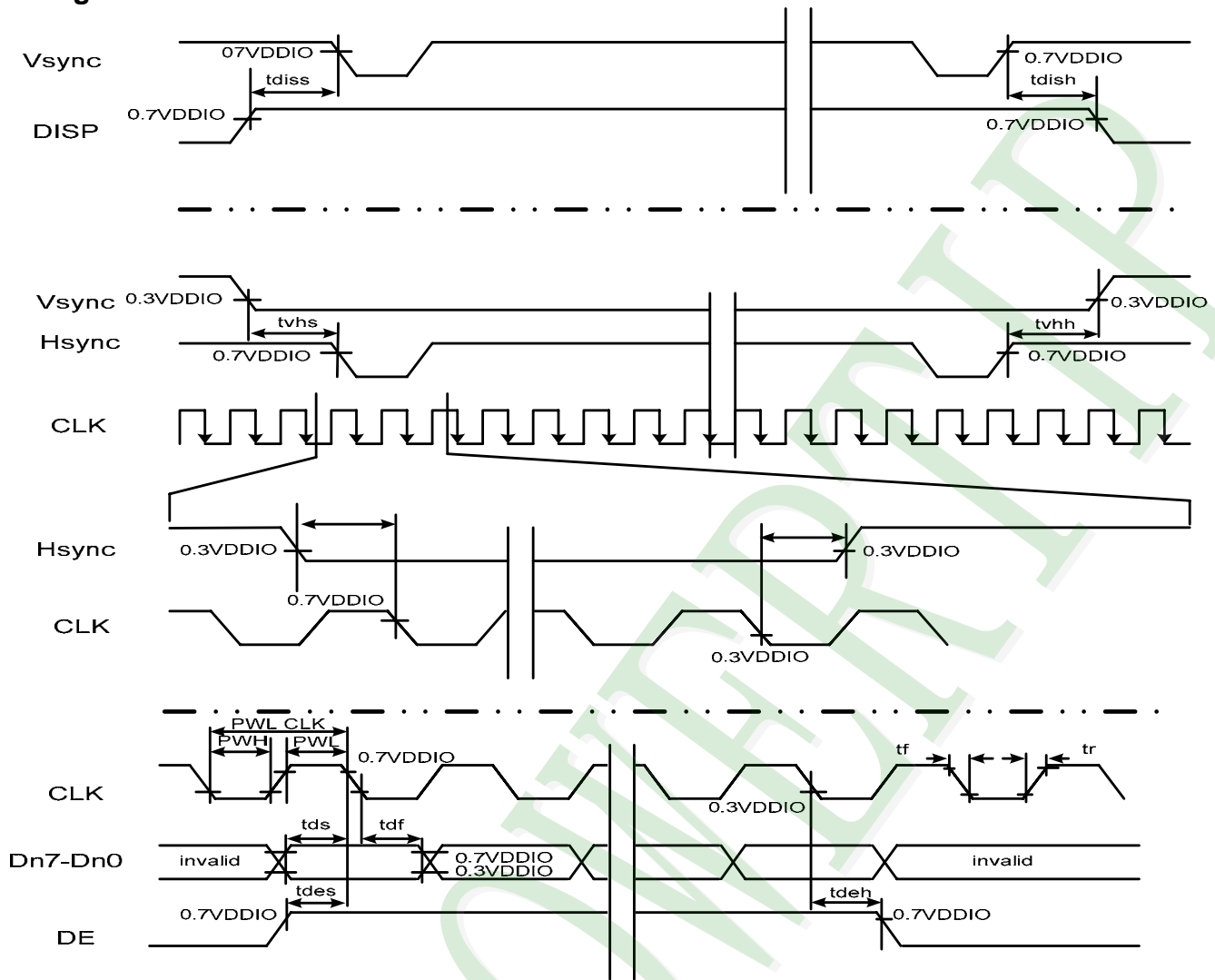

**Timing Chart 2**

### 2.3.1 SPI Write

First Transmission (Register)

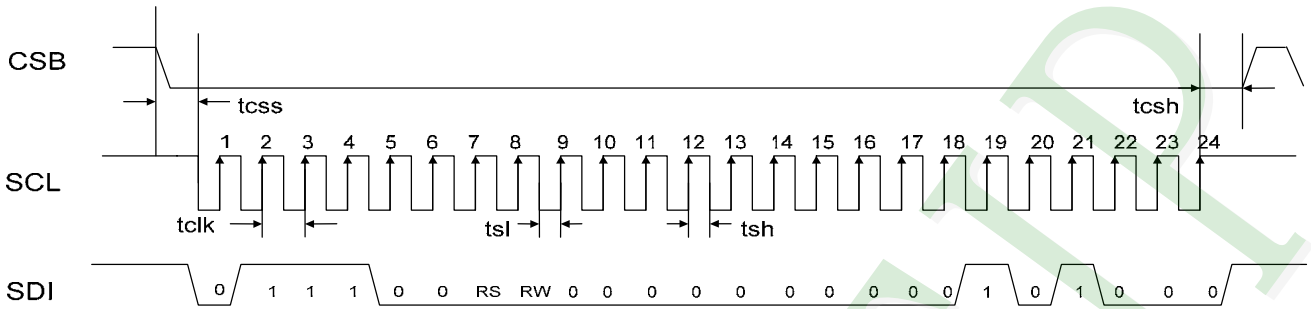

Second Transmission (Data)

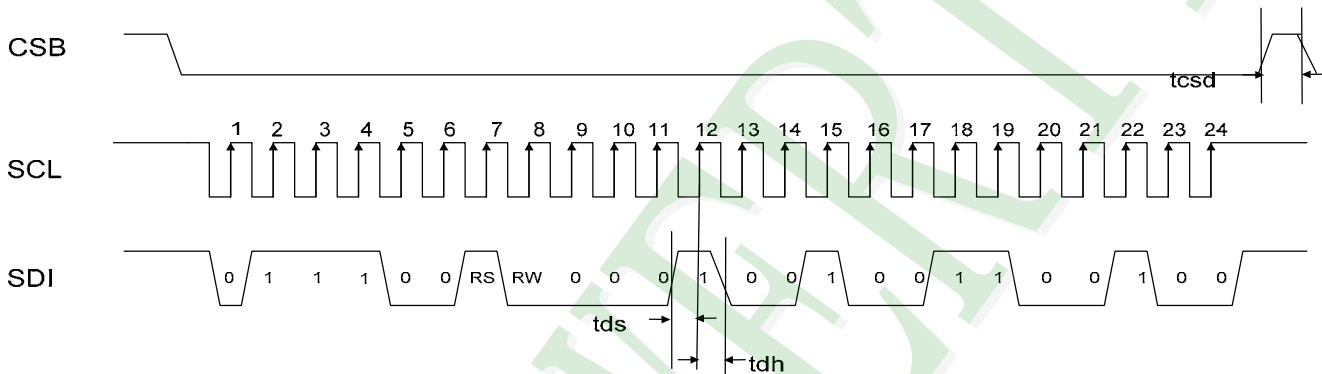

**Note:** The example writes “0x1264h” to register R28h.

### 2.3.2 SPI Timing Table

Parameter	Symbol	Spec.			Unit
		Min.	Typ.	Max.	
Serial Clock Frequency	fclk	-	-	20	MHz
Serial Clock Cycle Time	tclk	50	-	-	ns
Clock Low Width	tsl	25	-	-	ns
Clock High Width	tsh	25	-	-	ns
Chip Select Setup Time	tcss	0	-	-	ns
Chip Select Hold Time	tcsd	10	-	-	ns
Chip Select High Delay Time	tcsd	20	-	-	ns
Data Setup Time	tds	5	-	-	ns
Data Hold Time	tdh	10	-	-	ns

## 2.4 Color Data Assignment

COLOR	INPUT DATA	R DATA								G DATA								B DATA							
		R7	R6	R5	R4	R3	R2	R1	R0	G7	G6	G5	G4	G3	G2	G1	G0	B7	B6	B5	B4	B3	B2	B1	B0
		MSB				LSB				MSB				LSB				MSB				LSB			
BASIC COLOR	BLACK	0	0	0	0	0	0	0	0	0	0	0	0	0	0	0	0	0	0	0	0	0	0	0	0
	RED(255)	1	1	1	1	1	1	1	1	0	0	0	0	0	0	0	0	0	0	0	0	0	0	0	0
	GREEN(255)	0	0	0	0	0	0	0	0	1	1	1	1	1	1	1	1	0	0	0	0	0	0	0	0
	BLUE(255)	0	0	0	0	0	0	0	0	0	0	0	0	0	0	0	0	1	1	1	1	1	1	1	1
	CYAN	0	0	0	0	0	0	0	0	1	1	1	1	1	1	1	1	1	1	1	1	1	1	1	1
	MAGENTA	1	1	1	1	1	1	1	1	0	0	0	0	0	0	0	0	1	1	1	1	1	1	1	1
	YELLOW	1	1	1	1	1	1	1	1	1	1	1	1	1	1	1	1	0	0	0	0	0	0	0	0
	WHITE	1	1	1	1	1	1	1	1	1	1	1	1	1	1	1	1	1	1	1	1	1	1	1	1
RED	RED(0)	0	0	0	0	0	0	0	0	0	0	0	0	0	0	0	0	0	0	0	0	0	0	0	0
	RED(1)	0	0	0	0	0	0	0	1	0	0	0	0	0	0	0	0	0	0	0	0	0	0	0	0
	RED(2)	0	0	0	0	0	0	1	0	0	0	0	0	0	0	0	0	0	0	0	0	0	0	0	0
	RED(254)	1	1	1	1	1	1	1	0	0	0	0	0	0	0	0	0	0	0	0	0	0	0	0	0
	RED(255)	1	1	1	1	1	1	1	1	0	0	0	0	0	0	0	0	0	0	0	0	0	0	0	0
GREEN	GREEN(0)	0	0	0	0	0	0	0	0	0	0	0	0	0	0	0	0	0	0	0	0	0	0	0	0
	GREEN(1)	0	0	0	0	0	0	0	0	0	0	0	0	0	0	0	1	0	0	0	0	0	0	0	0
	GREEN(2)	0	0	0	0	0	0	0	0	0	0	0	0	0	0	1	0	0	0	0	0	0	0	0	0
	GREEN(254)	0	0	0	0	0	0	0	0	1	1	1	1	1	1	1	0	0	0	0	0	0	0	0	0
	GREEN(255)	0	0	0	0	0	0	0	0	1	1	1	1	1	1	1	1	0	0	0	0	0	0	0	0
BLUE	BLUE(0)	0	0	0	0	0	0	0	0	0	0	0	0	0	0	0	0	0	0	0	0	0	0	0	0
	BLUE(1)	0	0	0	0	0	0	0	0	0	0	0	0	0	0	0	0	0	0	0	0	0	0	0	1
	BLUE(2)	0	0	0	0	0	0	0	0	0	0	0	0	0	0	0	0	0	0	0	0	0	0	1	0
	BLUE(254)	0	0	0	0	0	0	0	0	0	0	0	0	0	0	0	0	1	1	1	1	1	1	1	0
	BLUE(255)	0	0	0	0	0	0	0	0	0	0	0	0	0	0	0	0	1	1	1	1	1	1	1	1

[Note]

- (1) Definition of gray scale  
Color (n) : n means level of gray scale  
Larger n means brighter level
- (2) Data: 1-High, 0-Low



## 2.5 Reference Initial code

Register(0x0006);  
Data(0x2020);



### 3. QUALITY ASSURANCE SYSTEM

#### 3.1 Quality Assurance Flow Chart

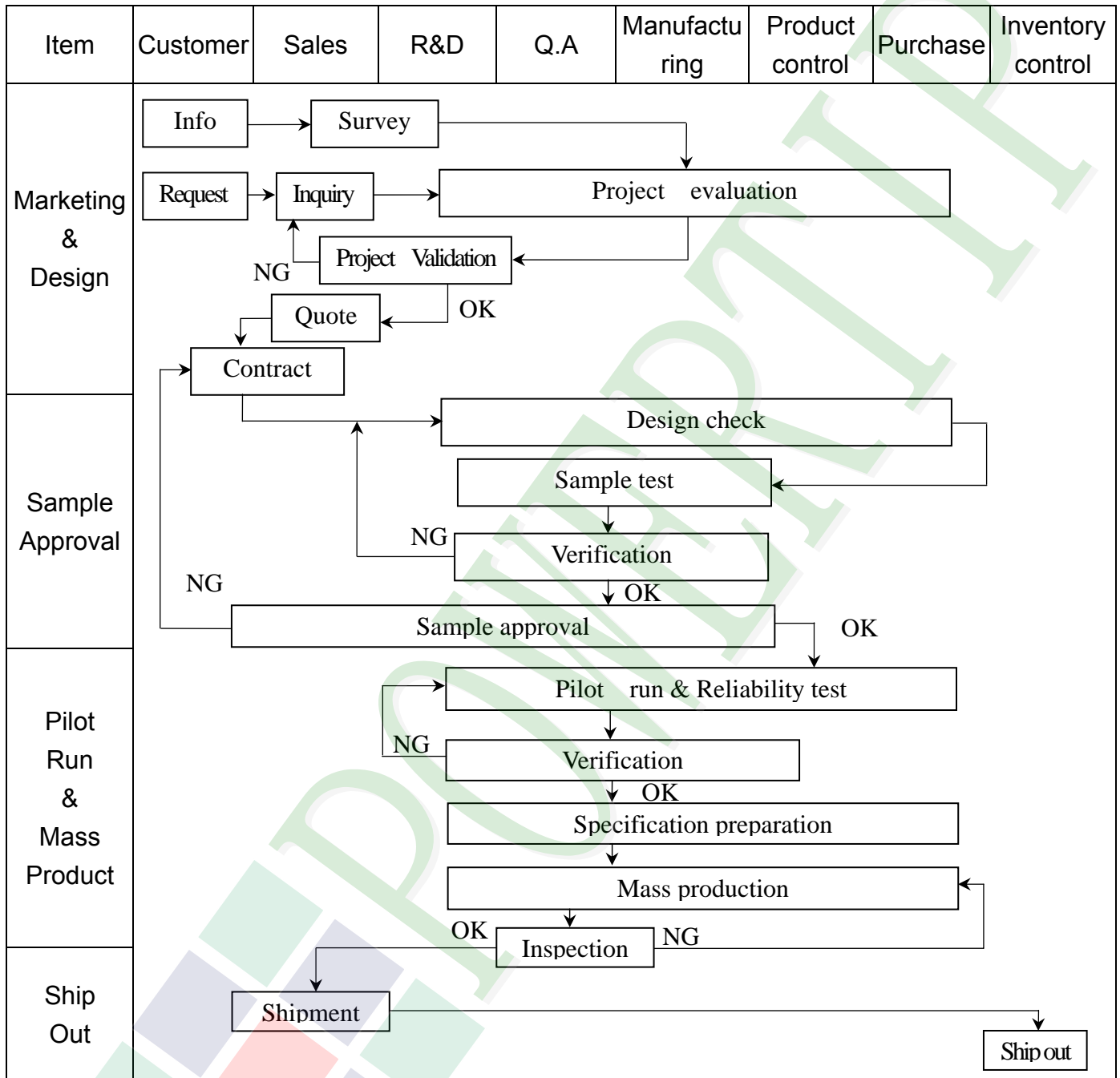

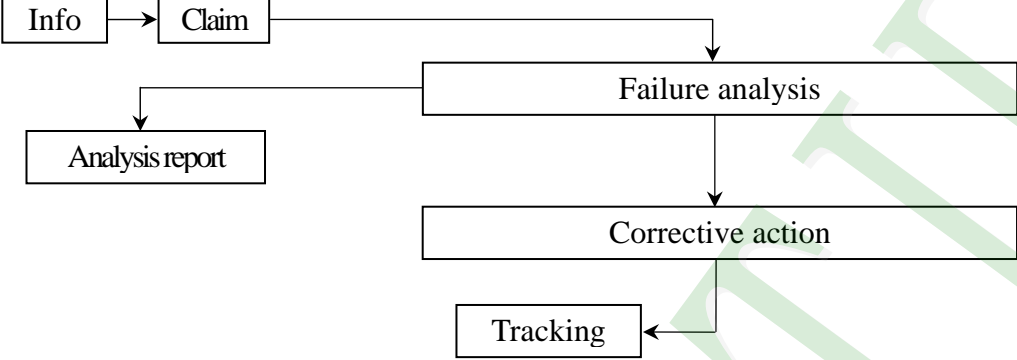
Item	Customer	Sales	R&D	Q.A	Manufacturing	Product control	Purchase	Inventory control
Sales Service	 <pre> graph TD     Info[Info] --&gt; Claim[Claim]     Claim --&gt; Failure[Failure analysis]     Failure --&gt; Report[Analysis report]     Failure --&gt; Action[Corrective action]     Action --&gt; Tracking[Tracking]           </pre>							
Q.A Activity	1. ISO 9001 Maintenance Activities 3. Equipment calibration 5. Standardization Management				2. Process improvement proposal 4. Education And Training Activities			

### 3.2 Inspection Specification

- ◆Scope : The document shall be applied to TFT-LCD Module for 3.5" ~10" (Ver. 03).
- ◆Inspection Standard : MIL-STD-105E Table Normal Inspection Single Sampling Level II.
- ◆Equipment : Gauge 、MIL-STD 、Powertip Tester 、Sample
- ◆Defect Level : Major Defect AQL : 0.4 ; Minor Defect AQL : 1.5
- ◆OUT Going Defect Level : Sampling.
- ◆Standard of the product appearance test :

a. Manner of appearance test :

- (1). The test best be under 20W×2 fluorescent light , and distance of view must be at 30 cm.
- (2). The test direction is base on about around 45° of vertical line.

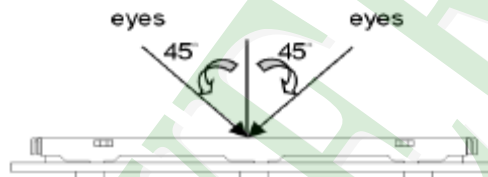

(3). Definition of area.

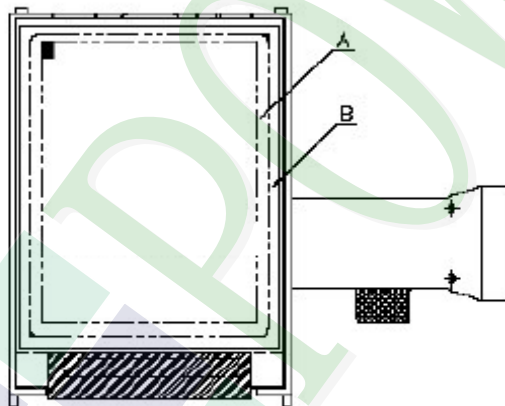

*A* area : viewing area

*B* area : Outside of viewing area

(4). Standard of inspection : (Unit : mm)

**◆ Specification For TFT-LCD Module 3.5" -10" :**
**(Ver. 03)**

NO	Item	Criterion	Level												
01	Product condition	1. 1 The part number is inconsistent with work order of production.	Major												
		1. 2 Mixed product types.	Major												
		1. 3 Assembled in inverse direction.	Major												
02	Quantity	2. 1 The quantity is inconsistent with work order of production.	Major												
03	Outline dimension	3. 1 Product dimension and structure must conform to structure diagram.	Major												
04	Electrical Testing	4. 1 Missing line character and icon.	Major												
		4. 2 No function or no display.	Major												
		4. 3 Display malfunction.	Major												
		4. 4 LCD viewing angle defect.	Major												
		4. 5 Current consumption exceeds product specifications.	Major												
05	Dot defect (Bright dot - Dark dot)  On -display	<table border="1" data-bbox="563 1319 1240 1621"> <thead> <tr> <th colspan="2">Item</th> <th>Acceptance (Q'ty)</th> </tr> </thead> <tbody> <tr> <td rowspan="4">Dot Defect</td> <td>Bright Dot</td> <td><math>\leq 4</math></td> </tr> <tr> <td>Dark Dot</td> <td><math>\leq 5</math></td> </tr> <tr> <td>Joint Dot</td> <td><math>\leq 3</math></td> </tr> <tr> <td>Total</td> <td><math>\leq 7</math></td> </tr> </tbody> </table> <p>5. 1 Inspection pattern : full white , full black , Red , Green and blue screens.</p> <p>5. 2 It is defined as dot defect if defect area <math>&gt; 1/2</math> dot.</p> <p>5. 3 The distance between two dot defect <math>\geq 5</math> mm.</p>	Item		Acceptance (Q'ty)	Dot Defect	Bright Dot	$\leq 4$	Dark Dot	$\leq 5$	Joint Dot	$\leq 3$	Total	$\leq 7$	Minor
Item		Acceptance (Q'ty)													
Dot Defect	Bright Dot	$\leq 4$													
	Dark Dot	$\leq 5$													
	Joint Dot	$\leq 3$													
	Total	$\leq 7$													

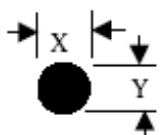
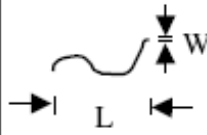

NO	Item	Criterion	Level																																						
06	<p>Black or white dot、scratch、contamination</p> <p>Round type</p>  <p><math>\Phi = (x + y) / 2</math></p> <p>Line type</p> 	<p><b>6.1 Round type ( Non-display or display ) :</b></p> <table border="1"> <thead> <tr> <th rowspan="2">Dimension (diameter : <math>\Phi</math>)</th> <th colspan="2">Acceptance (Q'ty)</th> </tr> <tr> <th>A area</th> <th>B area</th> </tr> </thead> <tbody> <tr> <td><math>\Phi \leq 0.25</math></td> <td>Ignore</td> <td rowspan="4">Ignore</td> </tr> <tr> <td><math>0.25 &lt; \Phi \leq 0.50</math></td> <td>5</td> </tr> <tr> <td><math>\Phi &gt; 0.50</math></td> <td>0</td> </tr> <tr> <td>Total</td> <td>5</td> </tr> </tbody> </table> <p><b>6.2 Line type( Non-display or display ) :</b></p> <table border="1"> <thead> <tr> <th colspan="2">Dimension</th> <th colspan="2">Acceptance (Q'ty)</th> </tr> <tr> <th>Length (L)</th> <th>Width (W)</th> <th>A area</th> <th>B area</th> </tr> </thead> <tbody> <tr> <td>---</td> <td><math>W \leq 0.03</math></td> <td>Ignore</td> <td rowspan="5">Ignore</td> </tr> <tr> <td><math>L \leq 10.0</math></td> <td><math>0.03 &lt; W \leq 0.05</math></td> <td>4</td> </tr> <tr> <td><math>L \leq 5.0</math></td> <td><math>0.05 &lt; W \leq 0.10</math></td> <td>2</td> </tr> <tr> <td>---</td> <td><math>W &gt; 0.10</math></td> <td>As round type</td> </tr> <tr> <td colspan="2">Total</td> <td>5</td> </tr> </tbody> </table>	Dimension (diameter : $\Phi$ )	Acceptance (Q'ty)		A area	B area	$\Phi \leq 0.25$	Ignore	Ignore	$0.25 < \Phi \leq 0.50$	5	$\Phi > 0.50$	0	Total	5	Dimension		Acceptance (Q'ty)		Length (L)	Width (W)	A area	B area	---	$W \leq 0.03$	Ignore	Ignore	$L \leq 10.0$	$0.03 < W \leq 0.05$	4	$L \leq 5.0$	$0.05 < W \leq 0.10$	2	---	$W > 0.10$	As round type	Total		5	Minor
Dimension (diameter : $\Phi$ )	Acceptance (Q'ty)																																								
	A area	B area																																							
$\Phi \leq 0.25$	Ignore	Ignore																																							
$0.25 < \Phi \leq 0.50$	5																																								
$\Phi > 0.50$	0																																								
Total	5																																								
Dimension		Acceptance (Q'ty)																																							
Length (L)	Width (W)	A area	B area																																						
---	$W \leq 0.03$	Ignore	Ignore																																						
$L \leq 10.0$	$0.03 < W \leq 0.05$	4																																							
$L \leq 5.0$	$0.05 < W \leq 0.10$	2																																							
---	$W > 0.10$	As round type																																							
Total		5																																							
07	Polarizer Bubble	<table border="1"> <thead> <tr> <th rowspan="2">Dimension (diameter : <math>\Phi</math>)</th> <th colspan="2">Acceptance (Q'ty)</th> </tr> <tr> <th>A area</th> <th>B area</th> </tr> </thead> <tbody> <tr> <td><math>\Phi \leq 0.25</math></td> <td>Ignore</td> <td rowspan="5">Ignore</td> </tr> <tr> <td><math>0.25 &lt; \Phi \leq 0.50</math></td> <td>4</td> </tr> <tr> <td><math>0.50 &lt; \Phi \leq 0.80</math></td> <td>1</td> </tr> <tr> <td><math>\Phi &gt; 0.80</math></td> <td>0</td> </tr> <tr> <td>Total</td> <td>5</td> </tr> </tbody> </table>	Dimension (diameter : $\Phi$ )	Acceptance (Q'ty)		A area	B area	$\Phi \leq 0.25$	Ignore	Ignore	$0.25 < \Phi \leq 0.50$	4	$0.50 < \Phi \leq 0.80$	1	$\Phi > 0.80$	0	Total	5	Minor																						
Dimension (diameter : $\Phi$ )	Acceptance (Q'ty)																																								
	A area	B area																																							
$\Phi \leq 0.25$	Ignore	Ignore																																							
$0.25 < \Phi \leq 0.50$	4																																								
$0.50 < \Phi \leq 0.80$	1																																								
$\Phi > 0.80$	0																																								
Total	5																																								



◆ Specification For TFT-LCD Module 3.5" ~10" :

(Ver. 03)

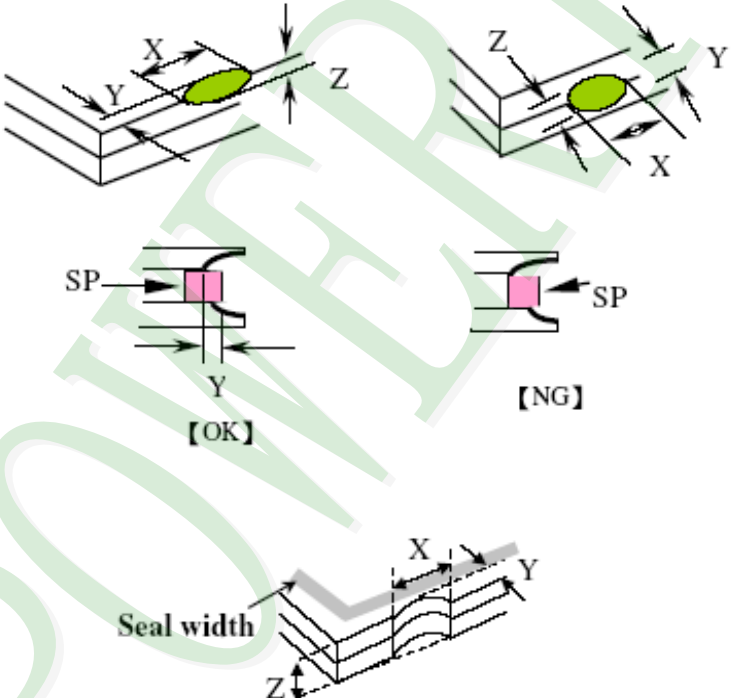
NO	Item	Criterion	Level						
08	The crack of glass	<p>Symbols :</p> <p>X : The length of crack            Z : The thickness of crack            t : The thickness of glass</p> <p>Y : The width of crack.            W : terminal length            a : LCD side length</p>	Minor						
		<p>8.1 General glass chip :</p> <p>8.1.1 Chip on panel surface and crack between panels:</p>  <table border="1" data-bbox="545 1568 1327 1854"> <thead> <tr> <th>X</th> <th>Y</th> <th>Z</th> </tr> </thead> <tbody> <tr> <td><math>\leq a</math></td> <td>Crack can't enter viewing area</td> <td><math>\leq 1/2 t</math></td> </tr> <tr> <td><math>\leq a</math></td> <td>Crack can't exceed the half of SP width.</td> <td><math>1/2 t &lt; Z \leq 2 t</math></td> </tr> </tbody> </table>		X	Y	Z	$\leq a$	Crack can't enter viewing area	$\leq 1/2 t$
X	Y	Z							
$\leq a$	Crack can't enter viewing area	$\leq 1/2 t$							
$\leq a$	Crack can't exceed the half of SP width.	$1/2 t < Z \leq 2 t$							

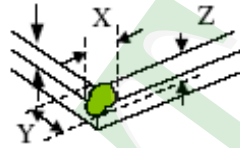
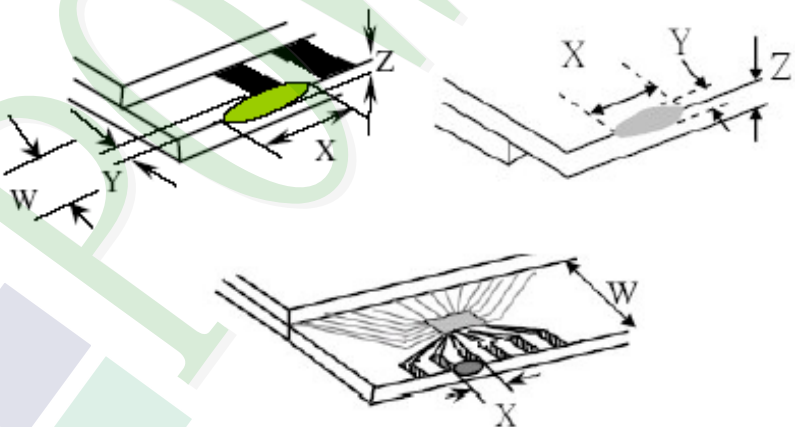
NO	Item	Criterion	Level										
08	The crack of glass	<p><b>Symbols :</b></p> <p>X : The length of crack            Z : The thickness of crack            t : The thickness of glass</p> <p>Y : The width of crack.            W : terminal length            a : LCD side length</p> <hr/> <p>8.1.2 Corner crack :</p>  <table border="1" data-bbox="518 779 1289 1064"> <thead> <tr> <th>X</th> <th>Y</th> <th>Z</th> </tr> </thead> <tbody> <tr> <td><math>\leq 1/5 a</math></td> <td>Crack can't enter viewing area</td> <td><math>Z \leq 1/2 t</math></td> </tr> <tr> <td><math>\leq 1/5 a</math></td> <td>Crack can't exceed the half of SP width.</td> <td><math>1/2 t &lt; Z \leq 2 t</math></td> </tr> </tbody> </table>	X	Y	Z	$\leq 1/5 a$	Crack can't enter viewing area	$Z \leq 1/2 t$	$\leq 1/5 a$	Crack can't exceed the half of SP width.	$1/2 t < Z \leq 2 t$	Minor	
		X	Y	Z									
$\leq 1/5 a$	Crack can't enter viewing area	$Z \leq 1/2 t$											
$\leq 1/5 a$	Crack can't exceed the half of SP width.	$1/2 t < Z \leq 2 t$											
<p>8.2 Protrusion over terminal :</p> <p>8.2.1 Chip on electrode pad :</p>  <table border="1" data-bbox="555 1680 1300 1848"> <thead> <tr> <th></th> <th>X</th> <th>Y</th> <th>Z</th> </tr> </thead> <tbody> <tr> <td>Front</td> <td><math>\leq a</math></td> <td><math>\leq 1/2 W</math></td> <td><math>\leq t</math></td> </tr> <tr> <td>Back</td> <td><math>\leq a</math></td> <td><math>\leq W</math></td> <td><math>\leq 1/2 t</math></td> </tr> </tbody> </table>		X	Y	Z	Front	$\leq a$	$\leq 1/2 W$	$\leq t$	Back	$\leq a$	$\leq W$	$\leq 1/2 t$	
	X	Y	Z										
Front	$\leq a$	$\leq 1/2 W$	$\leq t$										
Back	$\leq a$	$\leq W$	$\leq 1/2 t$										

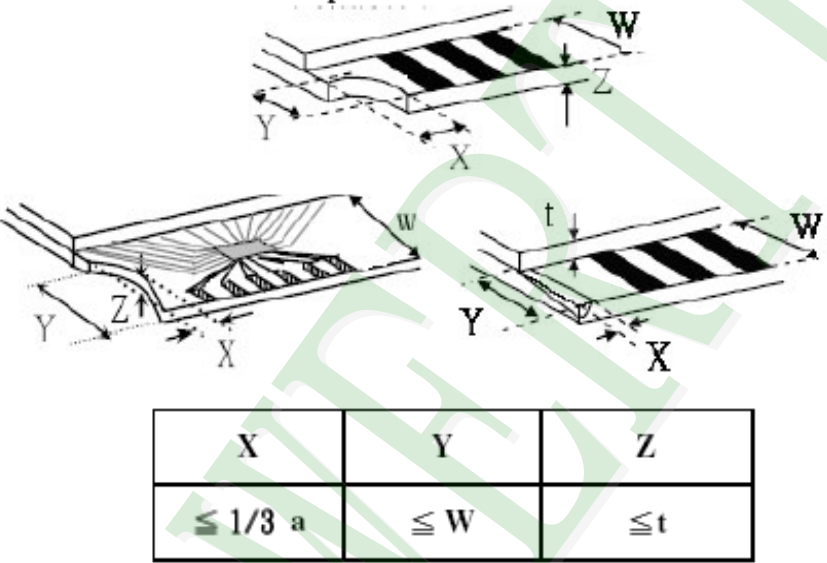
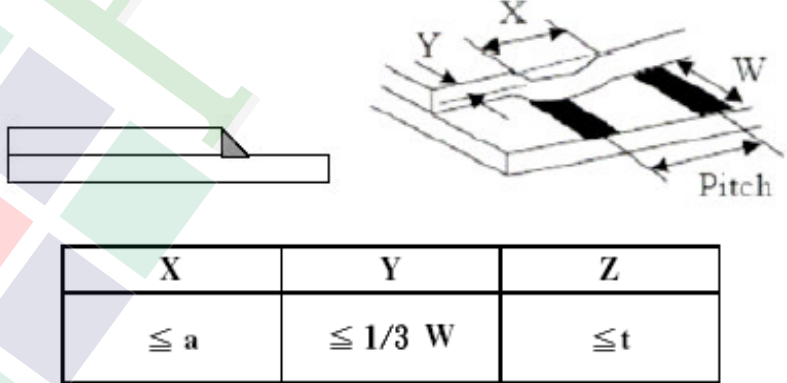
NO	Item	Criterion	Level
08	The crack of glass	<p><b>Symbols :</b></p> <p><b>X :</b> The length of crack  <b>Z :</b> The thickness of crack  <b>t :</b> The thickness of glass</p> <p><b>Y :</b> The width of crack.  <b>W :</b> terminal length  <b>a :</b> LCD side length</p>	Minor
		<p><b>8.2.2 Non-conductive portion :</b></p>  <p>⊙ If the chipped area touches the ITO terminal, over 2/3 of the ITO must remain and be inspected according to electrode terminal specifications.</p> <p><b>8.2.3 Glass remain :</b></p> 	



## ◆Specification For TFT-LCD Module 3.5" ~10" :

(Ver. 03)

NO	Item	Criterion	Level
09	Backlight elements	9. 1 Backlight can't work normally.	Major
		9. 2 Backlight doesn't light or color is wrong.	Major
		9. 3 Illumination source flickers when lit.	Major
10	General appearance	10. 1 Pin type · quantity · dimension must match type in structure diagram.	Major
		10. 2 No short circuits in components on PCB or FPC .	Major
		10. 3 Parts on PCB or FPC must be the same as on the production characteristic chart .There should be no wrong parts , missing parts or excess parts.	Major
		10. 4 Product packaging must the same as specified on packaging specification sheet.	Minor
		10. 5 The folding and peeled off in polarizer are not acceptable.	Minor
		10. 6 The PCB or FPC between B/L assembled distance(PCB or FPC ) is $\leq 1.5$ mm.	Minor

## 4. RELIABILITY TEST

### 4.1 Reliability Test Condition

Ver.03

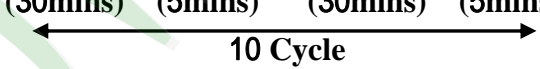
NO.	TEST ITEM	TEST CONDITION											
1	High Temperature Storage Test	Keep in <b>+80 ±2°C</b> 96 hrs Surrounding temperature, then storage at normal condition 4hrs.											
2	Low Temperature Storage Test	Keep in <b>-30 ±2°C</b> 96 hrs Surrounding temperature, then storage at normal condition 4hrs.											
3	High Temperature / High Humidity Storage Test	Keep in <b>+60°C / 90% R.H</b> duration for 96 hrs Surrounding temperature, then storage at normal condition 4hrs. (Excluding the polarizer)											
4	ESD Test	Air Discharge: Apply <b>2 KV</b> with 5 times Discharge for each polarity +/-	Contact Discharge: Apply <b>250 V</b> with 5 times discharge for each polarity +/-										
		1. Temperature ambience : <b>15°C ~ 35°C</b> 2. Humidity relative : <b>30% ~ 60%</b> 3. Energy Storage Capacitance(Cs+Cd) : <b>150pF±10%</b> 4. Discharge Resistance(Rd) : <b>330Ω±10%</b> 5. Discharge, mode of operation : Single Discharge (time between successive discharges at least 1 sec) (Tolerance if the output voltage indication : <b>±5%</b> )											
5	Temperature Cycling Storage Test	-20°C → +25°C → +70°C → +25°C (30mins) (5mins) (30mins) (5mins)  Surrounding temperature, then storage at normal condition 4hrs.											
6	Vibration Test (Packaged)	1. Sine wave <b>10 55</b> Hz frequency (1 min) 2. The amplitude of vibration : <b>1.5 mm</b> 3. Each direction (X、Y、Z) duration for <b>2 Hrs</b>											
7	Drop Test (Packaged)	<table border="1"> <thead> <tr> <th>Packing Weight (Kg)</th> <th>Drop Height (cm)</th> </tr> </thead> <tbody> <tr> <td>0 ~ 45.4</td> <td>122</td> </tr> <tr> <td>45.4 ~ 90.8</td> <td>76</td> </tr> <tr> <td>90.8 ~ 454</td> <td>61</td> </tr> <tr> <td>Over 454</td> <td>46</td> </tr> </tbody> </table> <p>Drop direction : ※1 corner / 3 edges / 6 sides each 1times</p>		Packing Weight (Kg)	Drop Height (cm)	0 ~ 45.4	122	45.4 ~ 90.8	76	90.8 ~ 454	61	Over 454	46
Packing Weight (Kg)	Drop Height (cm)												
0 ~ 45.4	122												
45.4 ~ 90.8	76												
90.8 ~ 454	61												
Over 454	46												

## 5. PRECAUTION RELATING PRODUCT HANDLING

### 5.1 SAFETY

- 5.1.1 If the LCD panel breaks , be careful not to get the liquid crystal to touch your skin.
- 5.1.2 If the liquid crystal touches your skin or clothes , please wash it off immediately by using soap and water.

### 5.2 HANDLING

- 5.2.1 Avoid any strong mechanical shock which can break the glass.
- 5.2.2 Avoid static electricity which can damage the CMOS LSI—When working with the module , be sure to ground your body and any electrical equipment you may be using.
- 5.2.3 Do not remove the panel or frame from the module.
- 5.2.4 The polarizing plate of the display is very fragile. So , please handle it very carefully ,do not touch , push or rub the exposed polarizing with anything harder than an HB pencil lead (glass , tweezers , etc.)
- 5.2.5 Do not wipe the polarizing plate with a dry cloth , as it may easily scratch the surface of plate.
- 5.2.6 Do not touch the display area with bare hands , this will stain the display area.
- 5.2.7 Do not use ketonics solvent & aromatic solvent. Use with a soft cloth soaked with a cleaning naphtha solvent.
- 5.2.8 To control temperature and time of soldering is  $320\pm 10^{\circ}\text{C}$  and 3-5 sec.
- 5.2.9 To avoid liquid (include organic solvent) stained on LCM .

### 5.3 STORAGE

- 5.3.1 Store the panel or module in a dark place where the temperature is  $25^{\circ}\text{C} \pm 5^{\circ}\text{C}$  and the humidity is below 65% RH.
- 5.3.2 Do not place the module near organics solvents or corrosive gases.
- 5.3.3 Do not crush , shake , or jolt the module.

### 5.4 TERMS OF WARRANTY

- 5.4.1 Applicable warrant period  
The period is within thirteen months since the date of shipping out under normal using and storage conditions.
- 5.4.2 Unaccepted responsibility  
This product has been manufactured to your company's specification as a part for use in your company's general electronic products. It is guaranteed to perform according to delivery specifications. For any other use apart from general electronic equipment , we cannot take responsibility if the product is used in nuclear power control equipment , aerospace equipment , fire and security systems or any other applications in which there is a direct risk to human life and where extremely high levels of reliability are required.

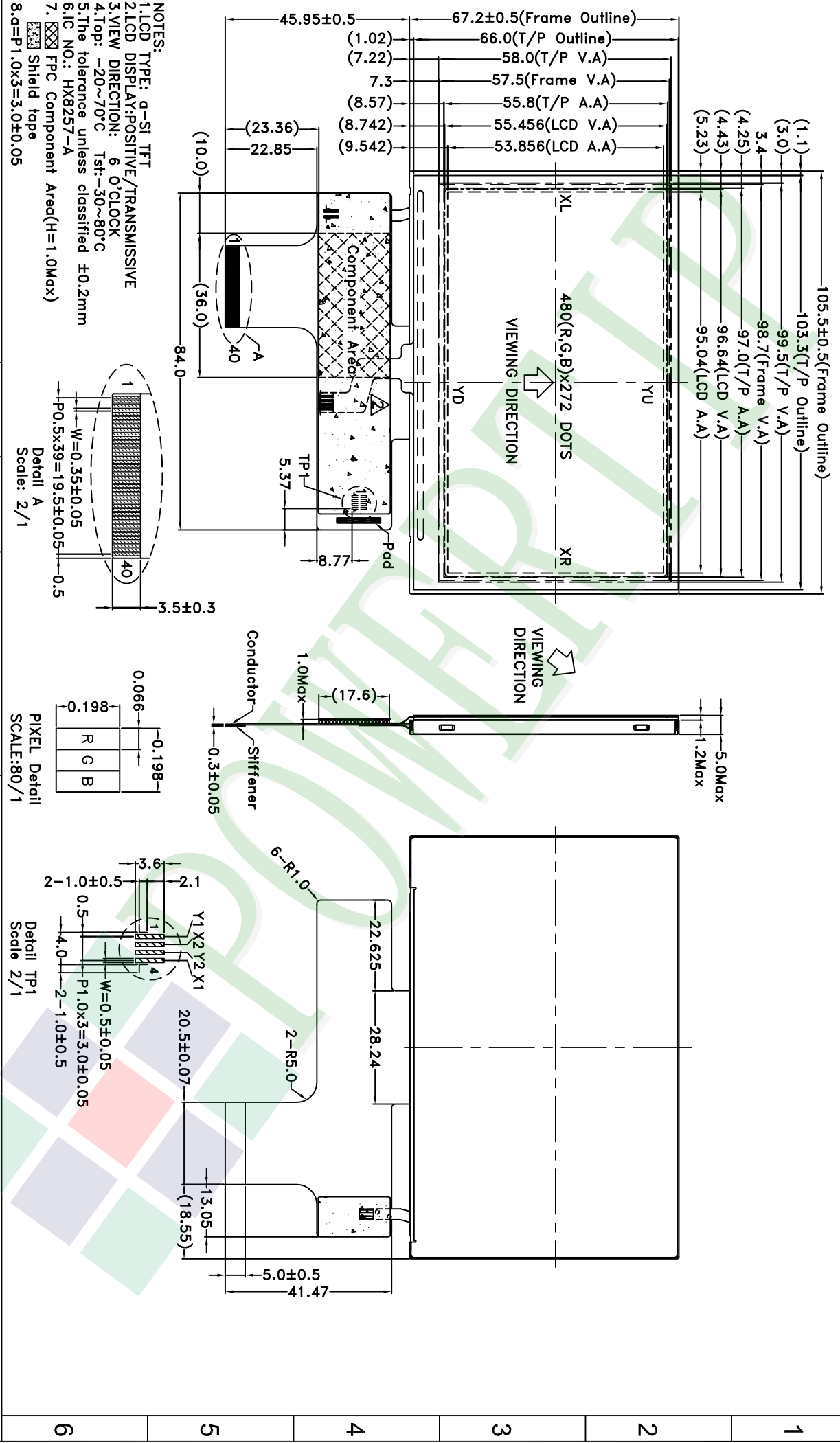

- NOTES:
1. LCD TYPE: q-Si TFT
  2. LCD DISPLAY: POSITIVE / TRANSMISSIVE
  3. VIEW DIRECTION: 6 O'CLOCK
  4. TOP: -20~-70°C Tst: -50~80°C
  5. The tolerance unless classified ±0.2mm
  6. IC NO.: HX8257-A
  7. FPC Component Area (H=1.0Max)
  8. Shield tape

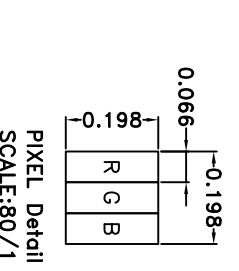
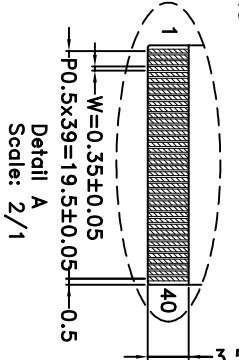

007																			
006																			
005																			
004																			
003																			
002	Modify FPC of TP		Mag		2009/04/24														
001	NEW DRAWING		Mag		2009/03/31														
REV		REV BY	REVISER	DATE															
		PART NO.:		PH480272T-005-111Q		DRAWING NAME:		LMD-PH480272T-005-111Q		TITLE:		LCD Module Drawing		Design		Mag		久正光电股份有限公司	
		DRAWING NAME:		LMD-PH480272T-005-111Q		TITLE:		LCD Module Drawing		Check		Stone		POWER TIP TECHNOLOGY CORPORATION		Unit		MM	
		DATE		2009/03/31		SCALE:		80/1		Approve		Linda		Surface		Thickness		1:1.3	
		DATE		2009/03/31		SCALE:		80/1		Approve		Linda		Material		Quantity		1/1	
		DATE		2009/03/31		SCALE:		80/1		Approve		Linda		Precision Level		Precision Level		250 ~ 1000	



# LCM包裝規格書

## LCM Packaging Specifications

(For Tray)

Approve	Check	Contact
Linda	Stone	Mag

Documents NO. PKG-PH480272T-005-I11Q

## 1. 包裝材料規格表 (Packaging Material) : (per carton)

No.	Item	Model	Dimensions (mm)	1Pcs Weight	Quantity	Total Weight
1	成品 (LCM)	PH480272T-005-I11Q	105.5 X 67.2	0.069	144	9.936
2	多層薄膜(1)POF	OTFILM0BA03ABA	19"X350X0.015	—	6	—
3	TRAY 盤 (2)Tray	TYPH48027201BA	352 X 260 X 12.8	0.1	42	4.2
4	內盒(3)Product Box	BX36627063ABBA	393 X 274 X 68	0.2692	6	1.6152
5	保利龍板(4)Polylon board	OTPLB00PL08ABA	550 X 393 X 20	0.0284	2	0.0568
6	外紙箱(5)Carton	BX57041027CCBA	570 X 410 X 265	1.4208	1	1.4208
7						
8						
9						

2. 一整箱總重量 (Total LCD Weight in carton) : 17.23 Kg±10%

3. 單箱數量規格表 (Packaging Specifications and Quantity) :

(1) LCM quantity per box : no per tray	4	x no of tray	6	=	24
(2) Total LCM quantity in carton : quantity per box	24	x no of boxes	6	=	144

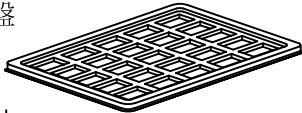
Use empty tray  
空盤

+

Put products into the tray

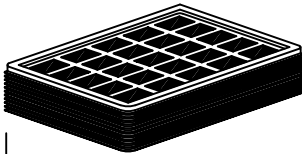

↓

Tray stacking

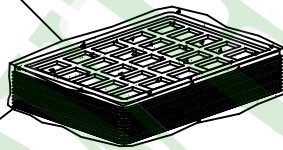
(1) 多層薄膜  
POF(2) TRAY 盤  
Tray

↓

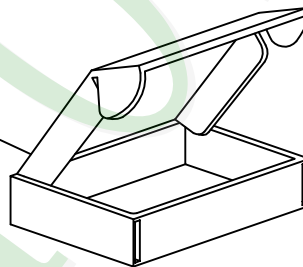
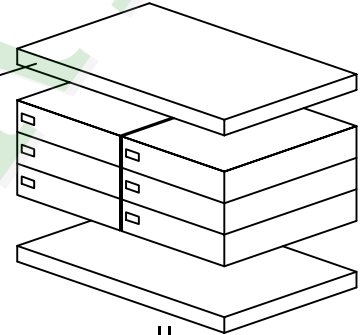
(3) 內盒  
Product Box(4) 保利龍板  
Polylon board

↓

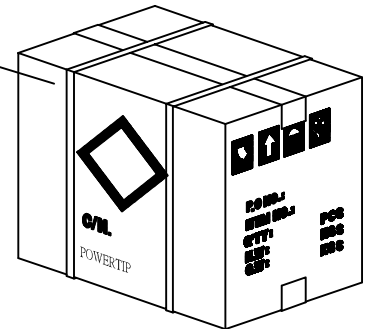
(5) 外紙箱  
Carton

## 特 記 事 項 (REMARK)

## 1. Label Specifications :

MODEL:  
LOT NO:  
QUANTITY:  
CHECK:

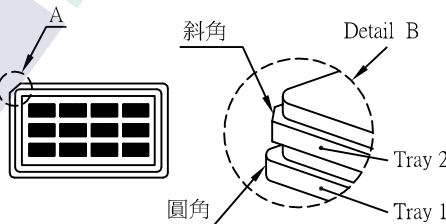

2. TRAY盤相疊時, 需旋轉180度, 請詳見B視圖  
Rotate tray 180 degrees and place on top of stack.  
Check the tray stack using Fig. B.

3. 可適用於單品包裝  
It's also suitable to Panel

4. Tray料號:  
Tray Number: PH480272T-001