

## Ultra Small, Low-Input Voltage, Low $R_{ON}$ Load Switch

### Features

- Integrated Load Switch
- Input Voltage: 0.75-V to 3.6-V
- Ultra-Low ON Resistance:
  - Max  $R_{ON}$  over temperature =  $9.8m\Omega$  at  $V_{IN} = 3.6V$
- Ultra Small CSP-8 package
  - 0.95 mm x 1.95 mm, 0.5-mm Pitch
- 4-A Maximum Continuous Switch Current
- Shutdown Current 5.5- $\mu A$  max
- Low Threshold Control Input
- Controlled Slew Rate to Avoid Inrush Currents
- Quick Output Discharge Transistor
- ESD Performance Tested Per JESD 22
  - 4000-V Human-Body Model (A114-B, Class II)
  - 1000-V Charged-Device Model (C101)

### Applications

- Notebook / Netbook Computer
- Tablet PC
- PDAs / Smartphones
- GPS Navigation Devices
- MP3 Players

### Description

The PI3PD22919 is a small, ultra-low  $r_{ON}$  load switch with controlled turn on. The device contains a N-channel MOSFET that can operate over an input voltage range of 0.75 V to 3.6 V and switch currents up to 4-A. An integrated charge pump biases the NMOS switch in order to achieve a minimum switch ON resistance ( $r_{ON}$ ). The switch is controlled by an on/off input ( $\overline{ON}$ ), via an active low enable pin.

The PI3PD22919 has a 1250 $\Omega$  on-chip load resistor for quick output discharge when the switch is turned off.

The PI3D22919 has an internally controlled rise time in order to reduce inrush current. The PI3D22919 features a rise time of 880 $\mu S$  at 3.6V.

The PI3D22919 is available in an ultra-small, space-saving 8-pin CSP package and is characterized for operation over the free-air temperature range of  $-40^{\circ}C$  to  $85^{\circ}C$ .

### Pin Configuration (Bottom View)

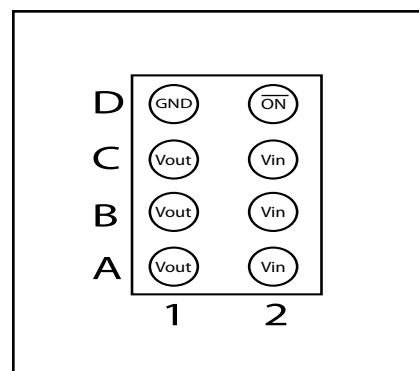

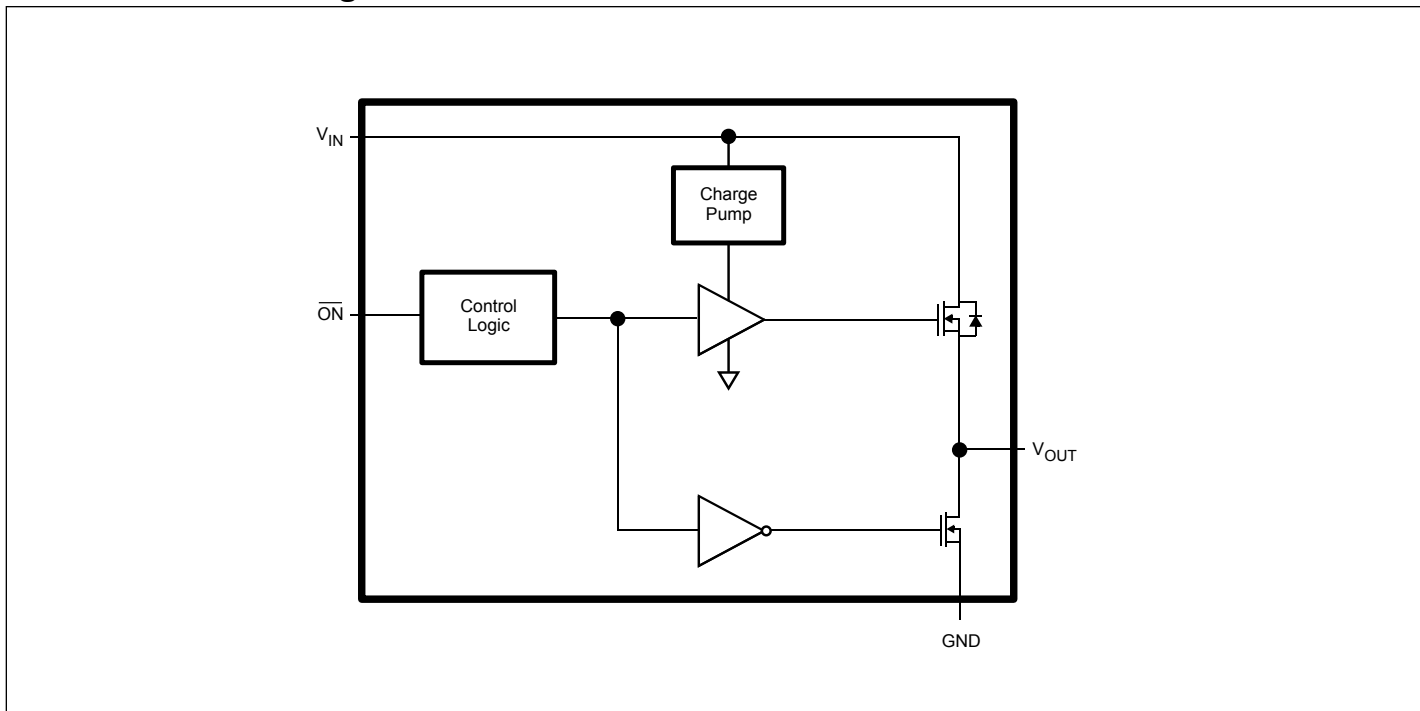
**Functional Block Diagram**

**Function Table**

$\overline{ON}$ (Control Input)	$V_{IN}$ to $V_{OUT}$	$V_{OUT}$ to GND
L	ON	OFF
H	OFF	ON

**Pin Description**

Terminal		Description
Ball No.	Name	
D1	GND	Ground
D2	$\overline{ON}$	Switch Control Input. Active low, do not leave floating.
A1, B1, C1	$V_{OUT}$	Switch Output
A2, B2, C2	$V_{IN}$	Switch Input. Bypass this input with a ceramic capacitor to ground.

**Absolute Maximum Ratings**

V <sub>IN</sub> , Input voltage range.....	-0.3V to 4V
V <sub>OUT</sub> , Output voltage range.....	V <sub>IN</sub> +0.3V
V <sub>ON</sub> , Input voltage range.....	-0.3V to 4V
I <sub>MAX</sub> , Maximum continuous switch current.....	4A
I <sub>PLS</sub> , Maximum pulsed current (100-μs pulse, 2% duty cycle).....	6A
T <sub>A</sub> , Operating free-air temperature range.....	-40 °C to 85 °C
T <sub>J</sub> , Maximum junction temperature.....	125 °C
T <sub>STG</sub> , Storage temperature range.....	-65 °C to 150 °C
T <sub>LEAD</sub> , Maximum lead temperature(10-s soldering time).....	300 °C
ESD, Electrostatic discharge protection , Charged Device Model(CDM).....	1000V
Human-Body Model(HBM).....	4000V

**Note:**

Stresses beyond those listed under absolute maximum ratings may cause permanent damage to the device. These are stress ratings only, and functional operation of the device at these or any other conditions beyond those indicated under Recommended Operating Conditions is not implied. Exposure to absolute-maximum-rated conditions for extended periods may affect device reliability.

**Recommended Operating Conditions**

Symbol	Parameter	Min.	Max.	Unit	
V <sub>IN</sub>	Input voltage range	0.75	3.6	V	
V <sub>OUT</sub>	Output voltage range		V <sub>IN</sub>	V	
V <sub>IH</sub>	High-level input voltage range, ON	V <sub>IN</sub> = 2.5 V to 3.6 V	1.2	3.6	V
		V <sub>IN</sub> = 0.75 V to 2.5 V	0.9	3.6	V
V <sub>IL</sub>	Low-level input voltage range, ON	V <sub>IN</sub> = 2.5 V to 3.6 V		0.6	V
		V <sub>IN</sub> = 0.75 V to 2.49 V		0.4	V
C <sub>IN</sub>	Input capacitor	1 <sup>(1)</sup>		μF	

**DC Electrical Characteristics** Unless otherwise specified, V<sub>IN</sub> = 0.75V to 3.6V

Parameter	Conditions	T <sub>A</sub> <sup>1</sup>	Min.	Typ.	Max.	Unit	
<b>Power Switch</b>							
I <sub>IN</sub>	Quiescent current	I <sub>OUT</sub> = 0, V <sub>ON</sub> = GND	V <sub>IN</sub> = 3.6V	Full	68	160	μA
			V <sub>IN</sub> = 2.5V		40	70	
			V <sub>IN</sub> = 1.8V		25	350	
			V <sub>IN</sub> = 1.2V		103	200	
			V <sub>IN</sub> = 1.0V		78	110	
			V <sub>IN</sub> = 0.75V		37	70	
I <sub>IN(LEAKAGE)</sub>	OFF-state supply current	V <sub>IN</sub> = V <sub>ON</sub> = 3.6V, V <sub>OUT</sub> = 0	Full		5.5	μA	
R <sub>ON</sub>	ON-state resistance	I <sub>OUT</sub> = -200 mA	V <sub>IN</sub> = 3.6V	25°C	7.1	8.8	mΩ
				Full		9.8	
			V <sub>IN</sub> = 2.5V	25°C	7.2	8.9	
				Full		9.9	
			V <sub>IN</sub> = 1.8V	25°C	7.3	9.1	
				Full		10.1	
			V <sub>IN</sub> = 1.2V	25°C	6.9	9.1	
				Full		10.4	
			V <sub>IN</sub> = 1.05V	25°C	7	9.2	
				Full		10.6	
			V <sub>IN</sub> = 0.75V	25°C	7.6	10.2	
				Full		11.6	
r <sub>PD</sub>	Output pulldown resistance	V <sub>IN</sub> = V <sub>ON</sub> = 3.3V, I <sub>OUT</sub> = 3mA	Full	1250	1500	Ω	
I <sub>ON</sub>	ON input leakage current	V <sub>ON</sub> = 0.9V to 3.6 V or GND	Full		0.1	μA	

**Note:**

1. Typical values are at V<sub>IN</sub> = 3.3 V and T<sub>A</sub> = 25°C.
2. See Output Pulldown in Application Information.

**Switching Characteristics**

Symbol	Parameter	Conditions			Min.	Typ.	Max.	Units
<b>V<sub>IN</sub> = 3.6V, T<sub>A</sub> = 25°C (Unless otherwise specified)</b>								
t <sub>ON</sub>	Turn-ON time	R <sub>L</sub> = 10Ω	C <sub>L</sub> = 0.1μF	V <sub>IN</sub> = 3.6V		970		μs
t <sub>OFF</sub>	Turn-OFF time					3		μs
t <sub>r</sub>	V <sub>OUT</sub> rise time					880		μs
t <sub>f</sub>	V <sub>OUT</sub> fall time					2		μs
<b>V<sub>IN</sub> = 0.9V, T<sub>A</sub> = 25°C (Unless otherwise specified)</b>								
t <sub>ON</sub>	Turn-ON time	R <sub>L</sub> = 10Ω	C <sub>L</sub> = 0.1μF	V <sub>IN</sub> = 0.9V		840		μs
t <sub>OFF</sub>	Turn-OFF time					16		μs
t <sub>r</sub>	V <sub>OUT</sub> rise time					470		μs
t <sub>f</sub>	V <sub>OUT</sub> fall time					5		μs

**Parameter Measurement Information**

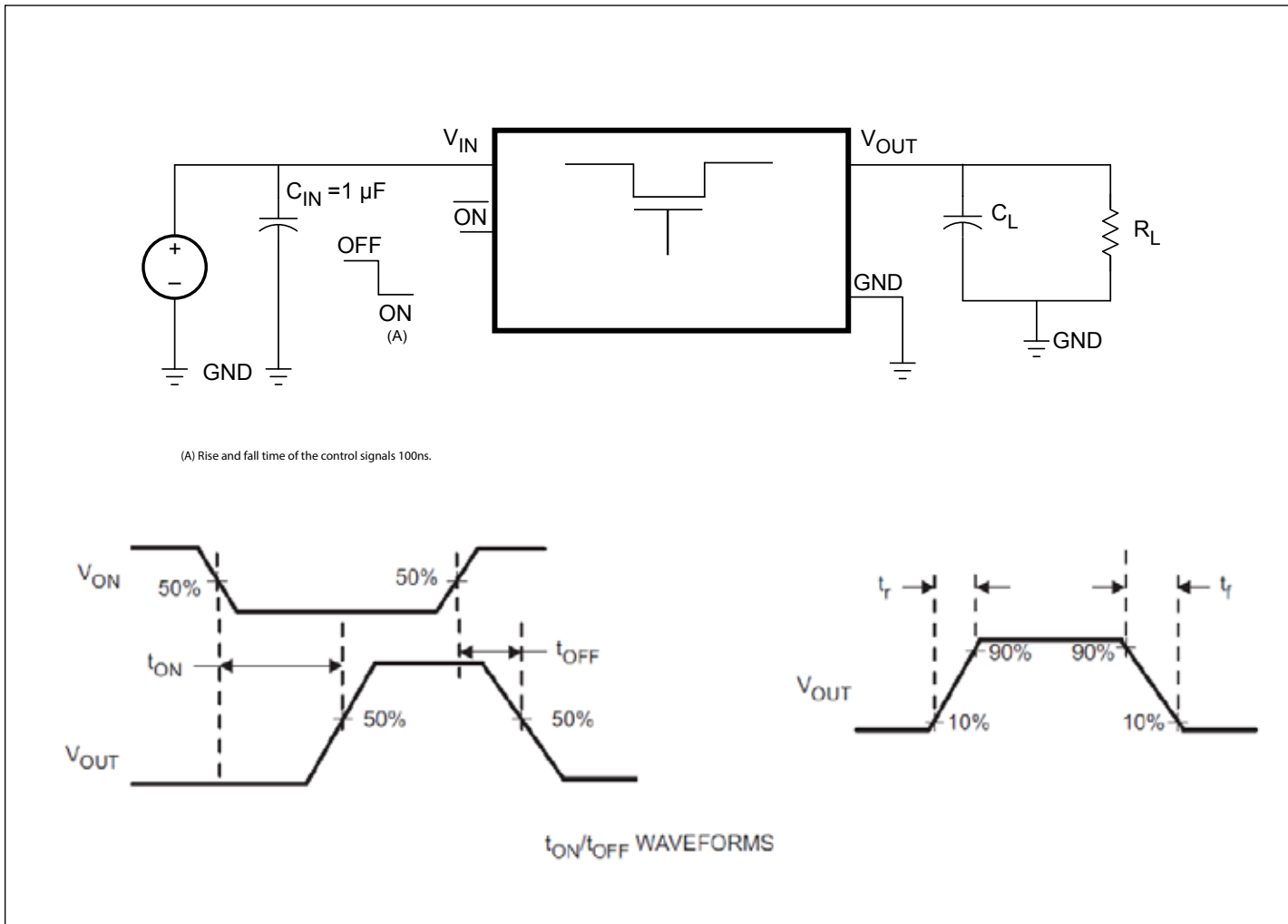

**Typical Characteristics**

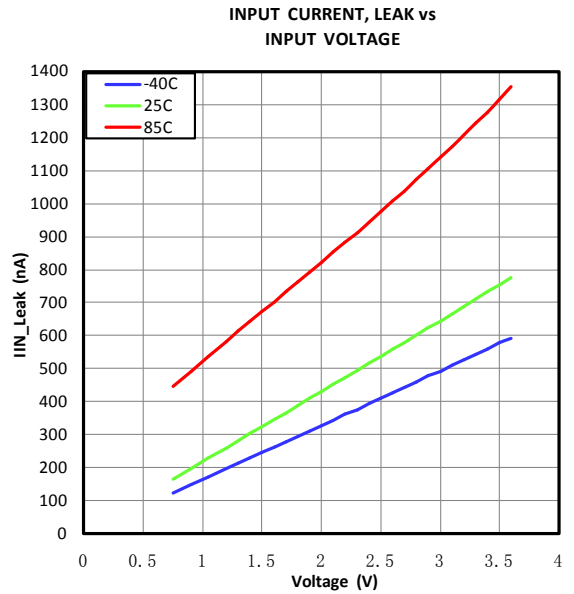
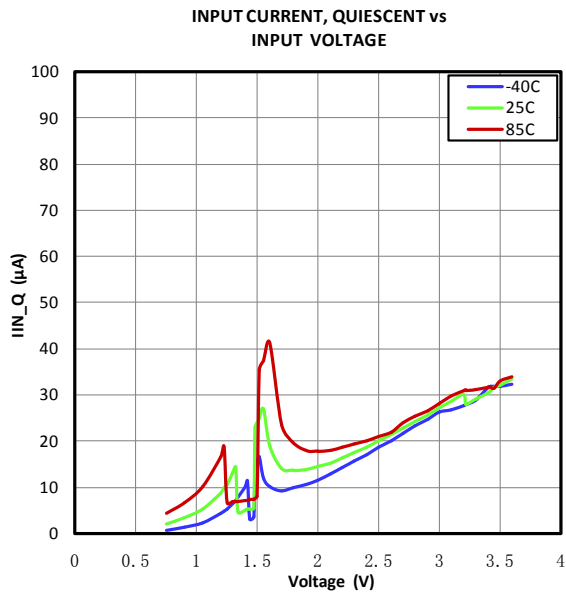
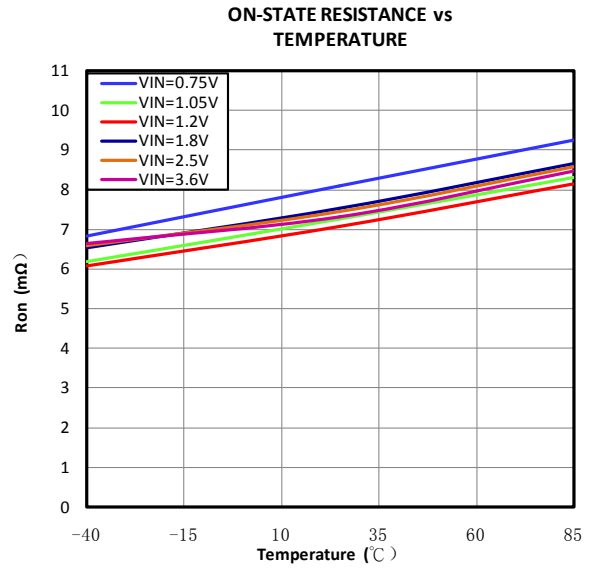
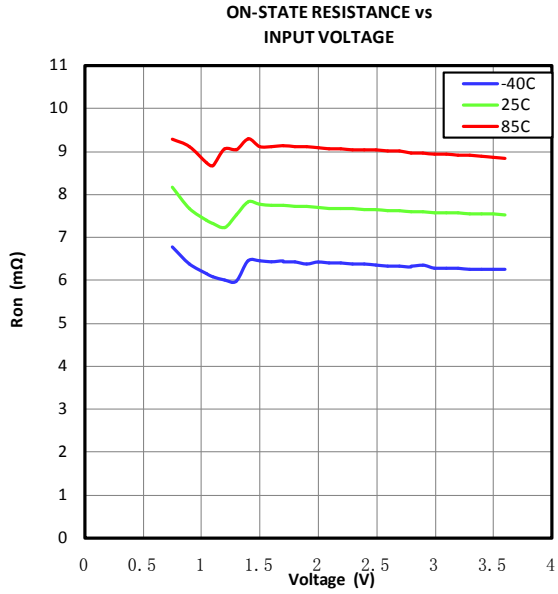

**ON INPUT THRESHOLD**

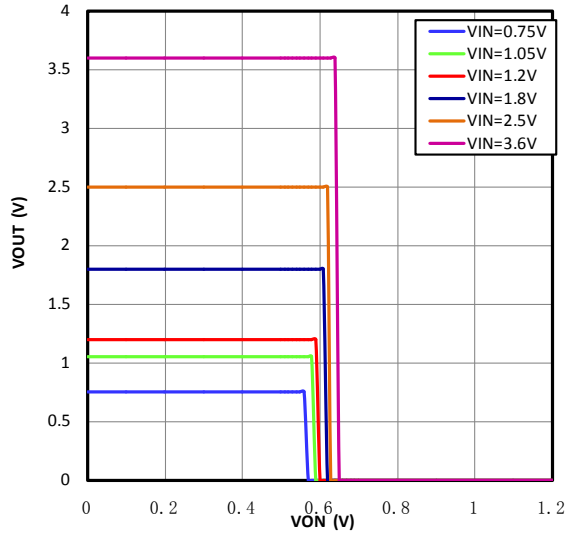

**TURN-ON TIME vs TEMPERATURE**

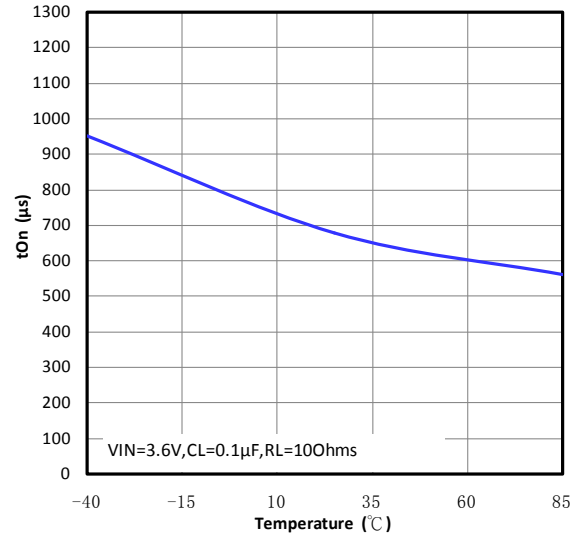

**TURN-OFF TIME vs TEMPERATURE**

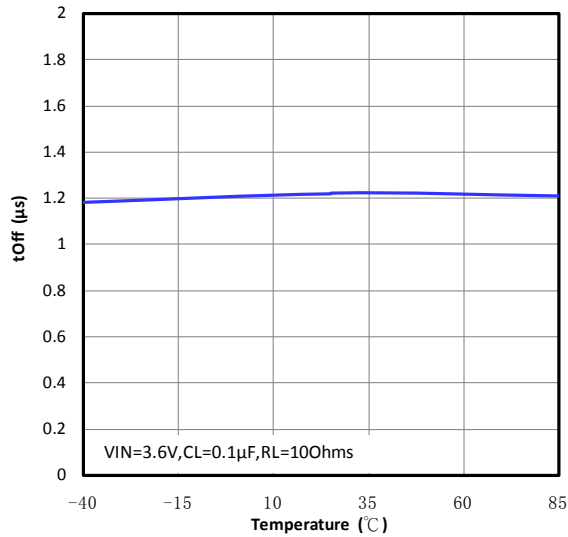

**RISE TIME vs TEMPERATURE**

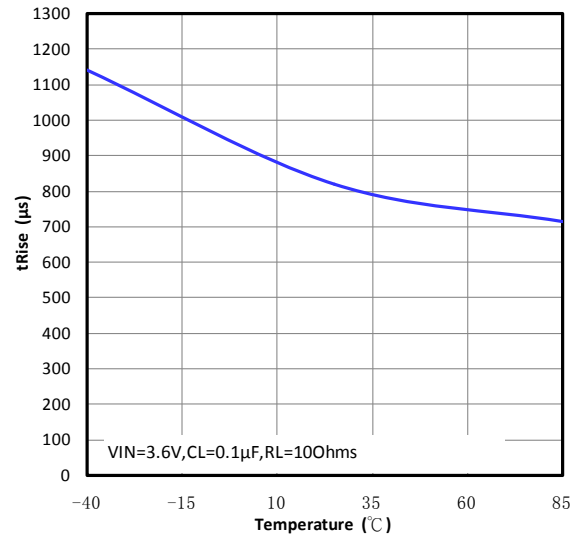

**FALL TIME vs TEMPERATURE**

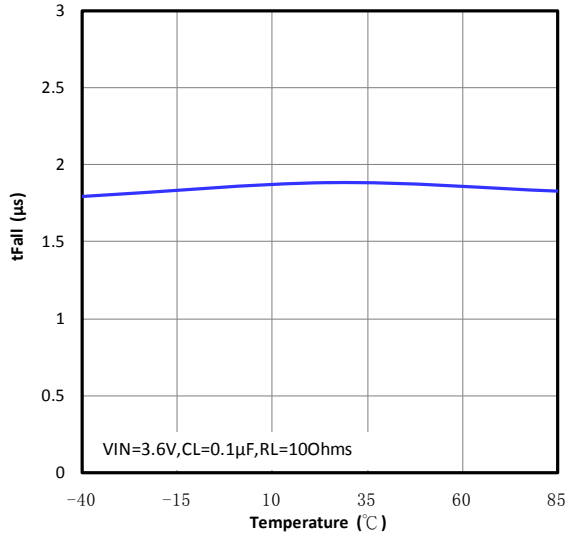

**TURN-ON TIME vs TEMPERATURE**

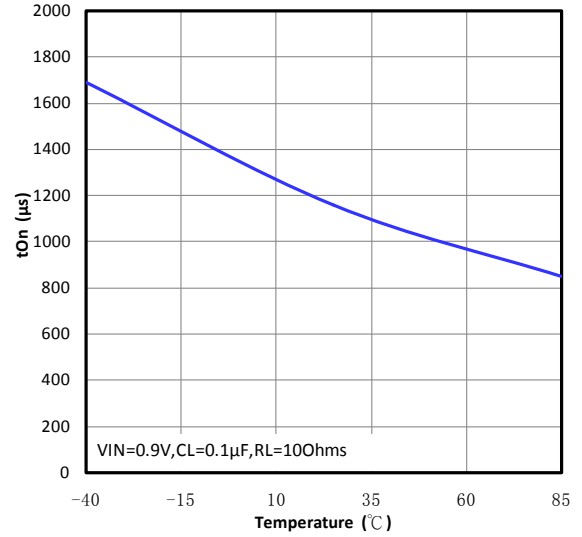

**TURN-OFF TIME vs TEMPERATURE**

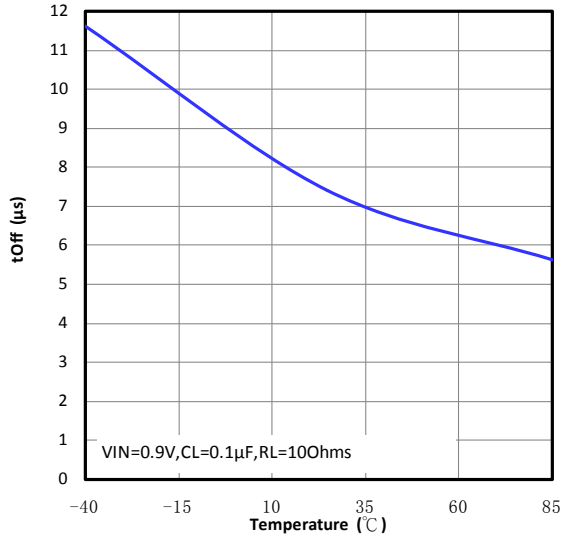

**RISE TIME vs TEMPERATURE**

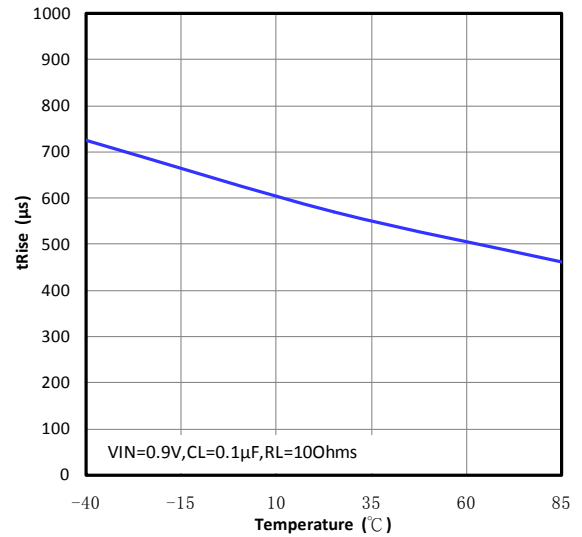



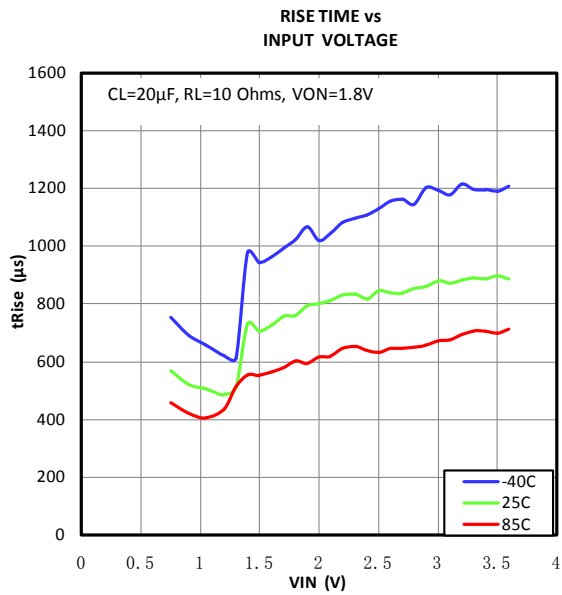
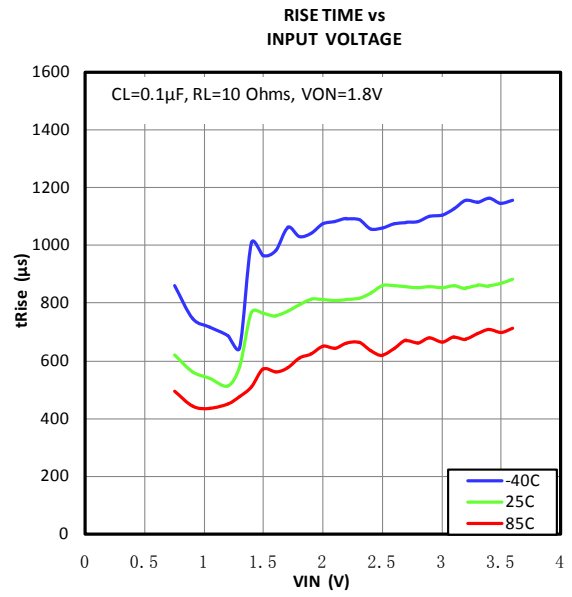
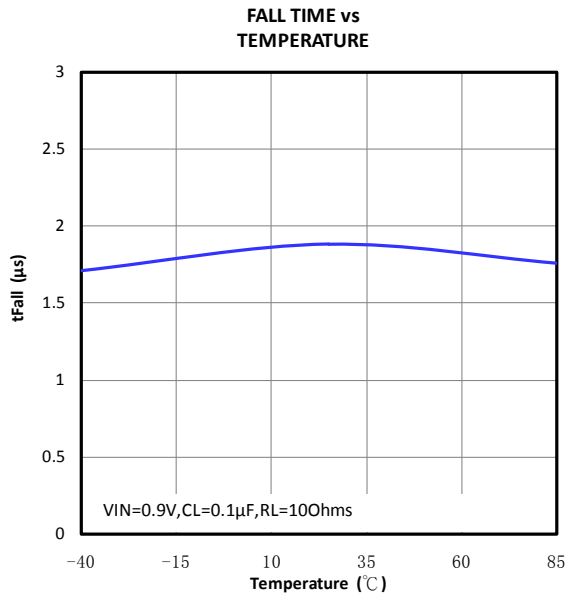

**TURN-ON RESPONSE**  
 $V_{in}=0.9V$ ,  $T_A=25C$ ,  $C_{IN}=1\mu F$ ,  $C_L=0.1\mu F$ ,  $R_L=10\Omega$

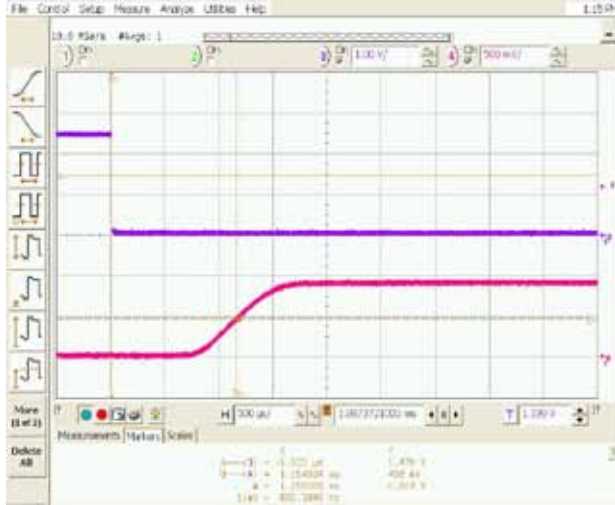

**TURN-OFF RESPONSE**  
 $V_{in}=0.9V$ ,  $T_A=25C$ ,  $C_{IN}=1\mu F$ ,  $C_L=0.1\mu F$ ,  $R_L=10\Omega$

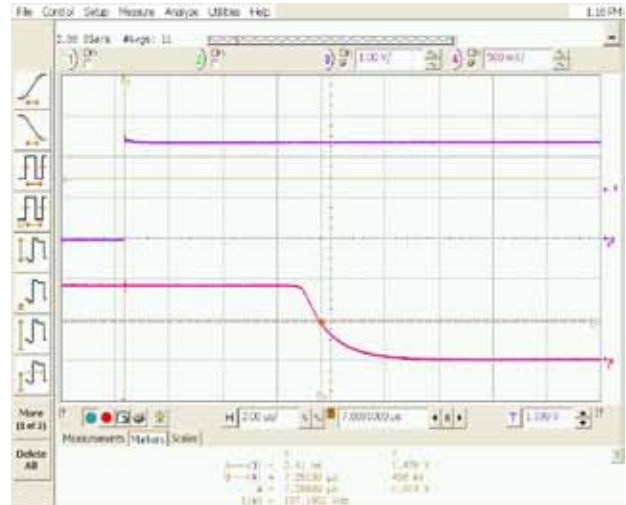

**TURN-ON RESPONSE**  
 $V_{in}=0.9V$ ,  $T_A=25C$ ,  $C_{IN}=47\mu F$ ,  $C_L=20\mu F$ ,  $R_L=10\Omega$

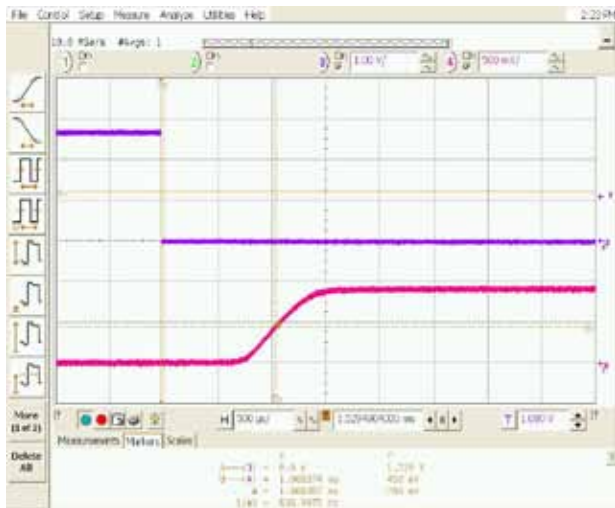

**TURN-OFF RESPONSE**  
 $V_{in}=0.9V$ ,  $T_A=25C$ ,  $C_{IN}=47\mu F$ ,  $C_L=20\mu F$ ,  $R_L=10\Omega$

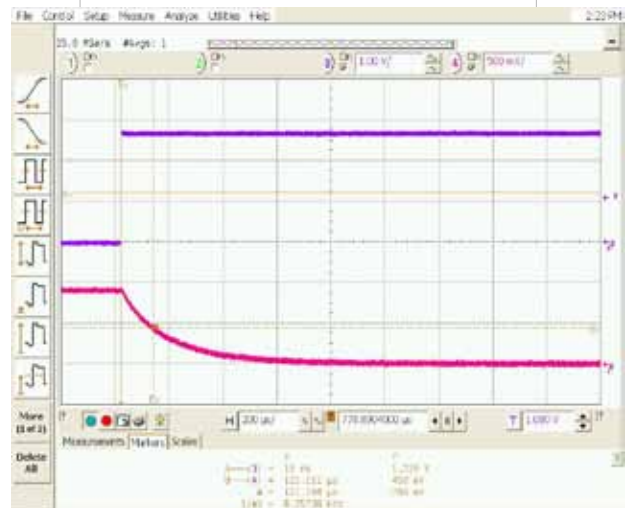

**TURN-ON RESPONSE**

$V_{in}=3.6V, T_A=25C, C_{IN}=1\mu F, C_L=0.1\mu F, R_L=10\Omega$

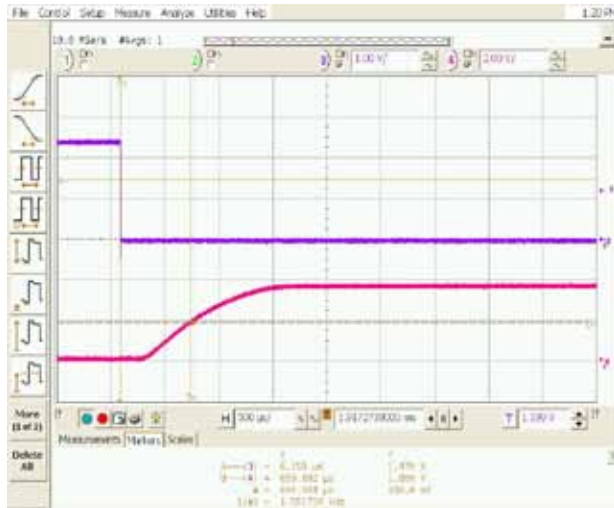

**TURN-OFF RESPONSE**

$V_{in}=3.6V, T_A=25C, C_{IN}=1\mu F, C_L=0.1\mu F, R_L=10\Omega$



**TURN-ON RESPONSE**

$V_{in}=3.6V, T_A=25C, C_{IN}=47\mu F, C_L=20\mu F, R_L=10\Omega$

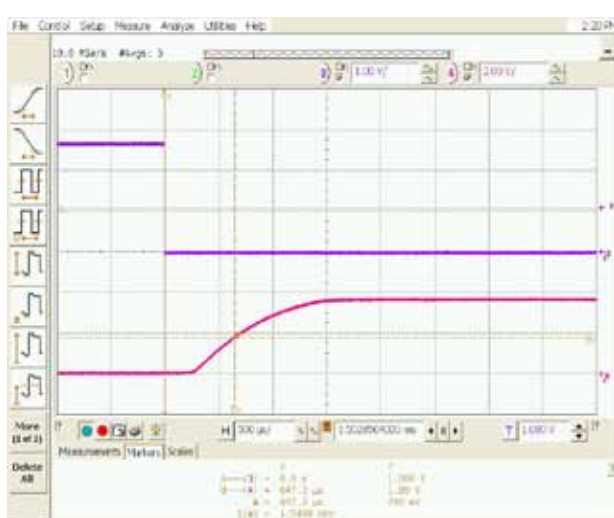

**TURN-OFF RESPONSE**

$V_{in}=3.6V, T_A=25C, C_{IN}=47\mu F, C_L=20\mu F, R_L=10\Omega$

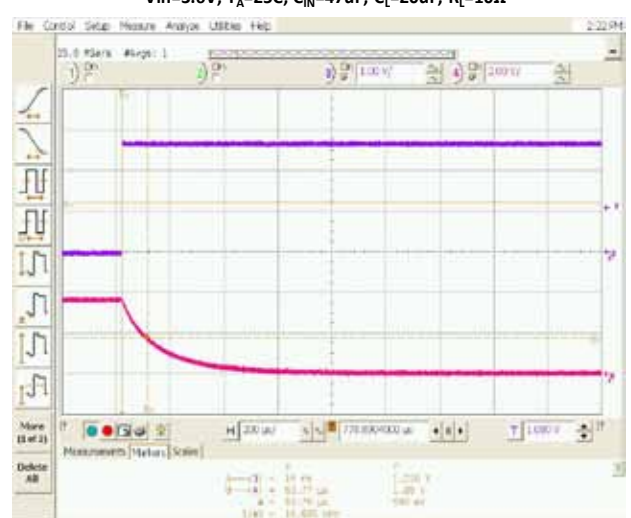

**Packaging Mechanicals: 8-contact CSP (GB)**

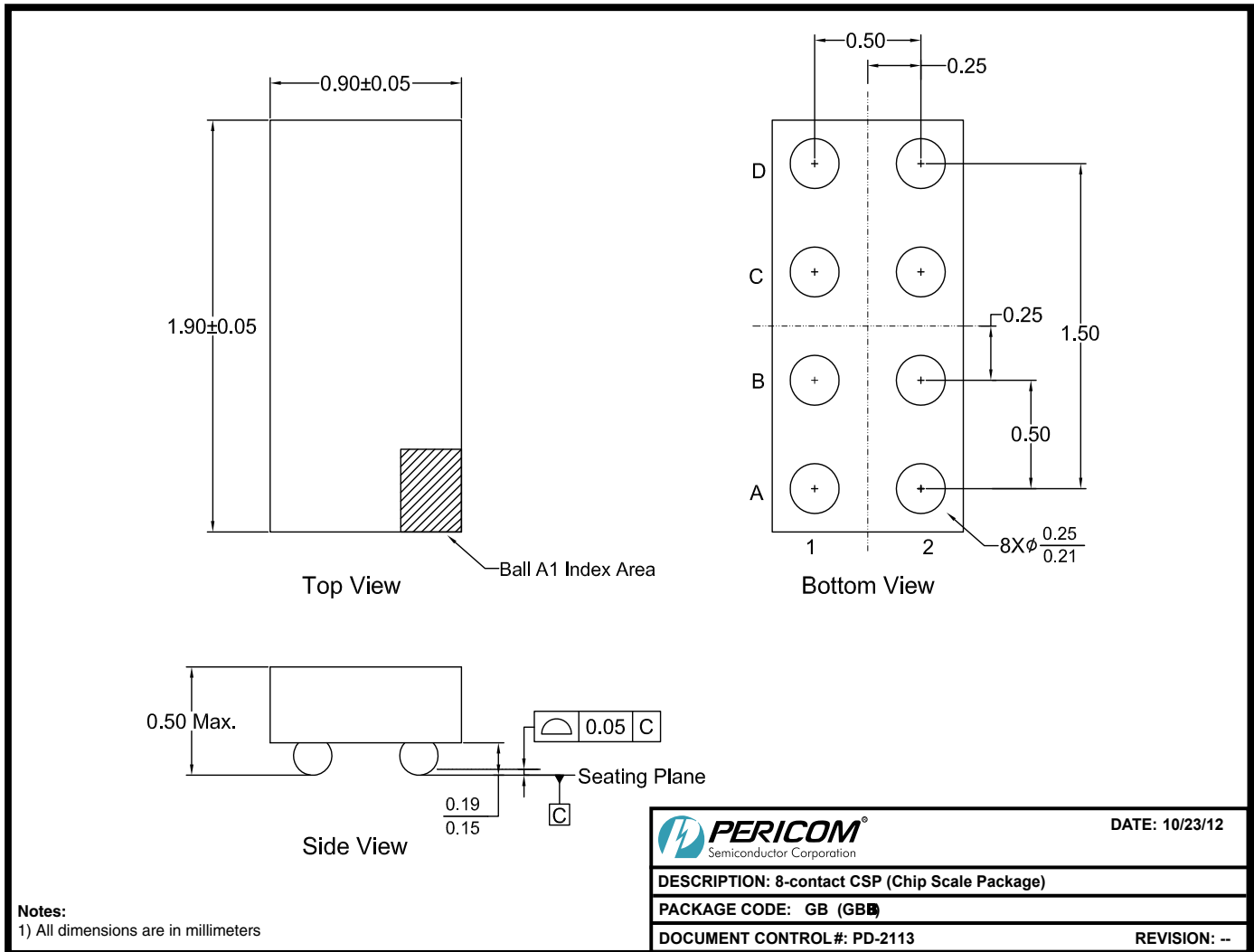

**Ordering Information<sup>(1-3)</sup>**

Ordering Code	Package Code	Package Description
PI3PD22919GBE	GB	8-contact Chip Scale Package (CSP), Pb-free & Green

**Notes:**

1. Thermal characteristics can be found on the company web site at [www.pericom.com/packaging/](http://www.pericom.com/packaging/)
2. E = Pb-free and Green
3. Adding an X suffix = Tape/Reel