

3-Terminal Fixed Voltage Positive Regulators

These voltage regulators are monolithic integrated circuits designed as fixed-voltage regulators for a wide variety of applications including local, on-card regulation. These regulators employ internal current limiting, thermal shutdown, and safe-area compensation.

FEATURES

- Output Current up to 1 Ampere
- No External Components Required
- Internal Thermal Overload Protection
- Internal Short-Circuit Current Limiting
- Output Transistor Safe-Area Compensation
- Output Voltage Offered in 4% Tolerance

CIRCUIT SCHEMATIC

Representative Schematic Diagram

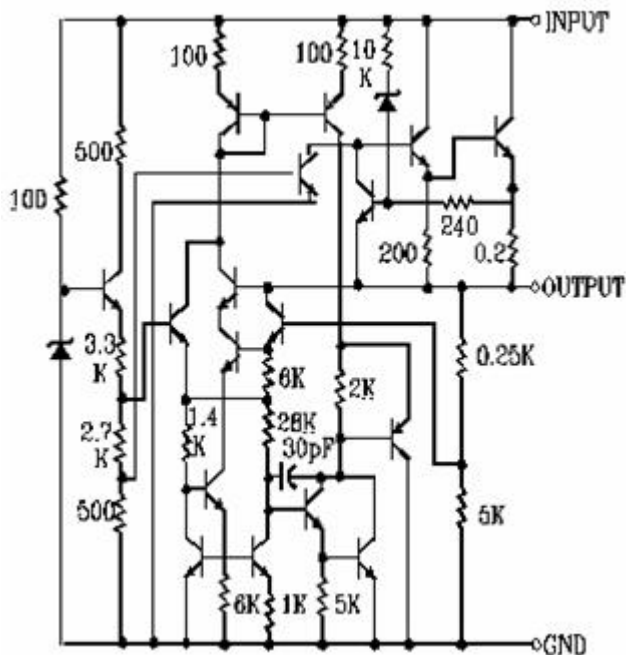

PIN ARRANGEMENT

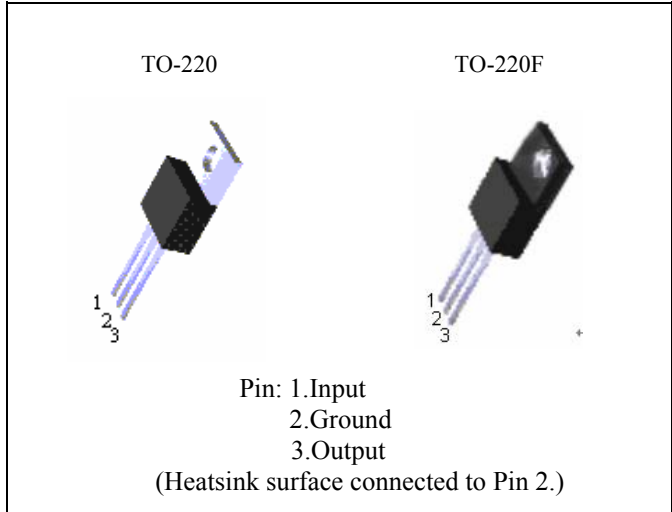

ORDERING INFORMATION

Device	Operating Temperature	Package
PJ78xxCZ	0°C ~ +70°C	TO-220
PJ78xxCI		TO-220F

Standard Application

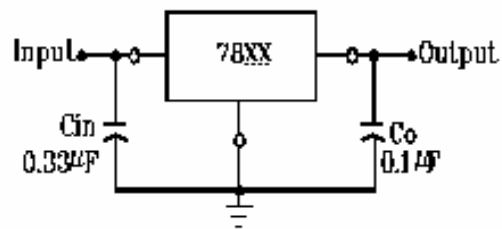

A common ground is required between the input and the output voltages. The input voltage must remain typically 2.0V above the output voltage even during the low point on the Input ripple voltage.

XX = these two digits of the type number indicate voltage.

* = Cin is required if regulator is located an appreciable distance from power supply filter.

** = Co is not needed for stability; however, it does improve transient response.

3-Terminal Fixed Voltage Positive Regulators

• ABSOLUTE MAXIMUM RATINGS (Ta=25°C)

RATING	SYMBOL	PJ7800B Series	UNIT
Input Voltage	Vin *	35	V
Input Voltage	Vin **	40	V
Power Dissipation TO-220	Without heatsink	2	°C / W
TO-220	Pt ***	15	
TO-220F	With heatsink	10	
Operating Ambient Temperature	Topr	0 to +70	°C
Operating Junction Temperature	Tj	0 to +150	°C
Storage Temperature	Tstg	-25 to +150	°C

Note: * PJ7805B to PJ7818B
 ** PJ7824B
 *** Follow the derating curve

• PJ7805B ELECTRICAL CHARACTERISTICS

(Vin=10V, Iout=500mA, 0°C ≤ Tj ≤ 125°C, Cin=0.33 μF, Cout=0.1 μF; unless otherwise specified.)

CHARACTERISTICS	SYMBOL	TEST CONDITIONS	MIN.	TYP.	MAX.	UNIT	
Output Voltage	Vout	Tj=25°C	4.80	5	5.20	V	
		7V ≤ Vin ≤ 20V, 5mA ≤ Iout ≤ 1A, PD ≤ 15W	4.75	5	5.25		
Line Regulation	REGline	Tj=25°C	7.5V ≤ Vin ≤ 25V	--	3	100	mV
			8V ≤ Vin ≤ 12V	--	1	50	mV
Load Regulation	REGload	Tj=25°C	5mA ≤ Iout ≤ 1A	--	15	100	mV
			250mA ≤ Iout ≤ 750mA	--	5	50	mV
Quiescent Current	Iq	Iout=0, Tj=25°C	--	4.2	8	mA	
Quiescent Current Change	ΔIq	7V ≤ Vin ≤ 25V	--	--	1.3	mA	
		5mA ≤ Iout ≤ 1A	--	--	0.5	mA	
Output Noise Voltage	Vn	10Hz ≤ f ≤ 100KHz, Tj=25°C	--	40	--	μV	
Ripple Rejection Ratio	RR	f=120Hz, 8V ≤ Vin ≤ 18V	62	78	--	dB	
Voltage Drop	Vdrop	Iout=1.0A, Tj=25°C	--	2	--	V	
Output Resistance	Rout	f=1KHz	--	17	--	mΩ	
Output Short Circuit Current	Ios	Tj=25°C	--	750	--	mA	
Peak Output Current	Io peak	Tj=25°C	--	2.2	--	A	
Temperature Coefficient of Output Voltage	ΔVout/ΔTj	Iout=5mA, 0°C ≤ Tj ≤ 125°C	--	-0.6	--	mV/°C	

* Pulse testing techniques are used to maintain the junction temperature as close to the ambient temperature as possible, and thermal effects must be taken into account separately.

** This specification applies only for DC power dissipation permitted by absolute maximum ratings.

3-Terminal Fixed Voltage Positive Regulators

• PJ7806B ELECTRICAL CHARACTERISTICS

($V_{in}=11V$, $I_{out}=500mA$, $0^{\circ}C \leq T_j \leq 125^{\circ}C$, $C_{in}=0.33 \mu F$, $C_{out}=0.1 \mu F$; unless otherwise specified.)

CHARACTERISTICS	SYMBOL	TEST CONDITIONS	MIN.	TYP.	MAX.	UNIT	
Output Voltage	Vout	Tj=25°C	5.75	6	6.25	V	
		8V ≤ Vin ≤ 21V, 5mA ≤ Iout ≤ 1A, PD ≤ 15W	6.3	6	6.3		
Line Regulation	REGline	Tj=25°C	8V ≤ Vin ≤ 25V	--	5	120	mV
			9V ≤ Vin ≤ 13V	--	1.5	60	mV
Load Regulation	REGload	Tj=25°C	5mA ≤ Iout ≤ 1A	--	14	120	mV
			250mA ≤ Iout ≤ 750mA	--	4	60	mV
Quiescent Current	Iq	Iout=0, Tj=25°C	--	4.3	8	mA	
Quiescent Current Change	Δ Iq	8V ≤ Vin ≤ 25V 5mA ≤ Iout ≤ 1A	--	--	1.3	mA	
			--	--	0.5	mA	
Output Noise Voltage	Vn	10Hz ≤ f ≤ 100KHz, Tj=25°C	--	45	--	μV	
Ripple Rejection Ratio	RR	f=120Hz, 9V ≤ Vin ≤ 19V	59	75	--	dB	
Voltage Drop	Vdrop	Iout=1.0A, Tj=25°C	--	2	--	V	
Output Resistance	Rout	f=1KHz	--	19	--	mΩ	
Output Short Circuit Current	Ios	Tj=25°C	--	550	--	mA	
Peak Output Current	Io peak	Tj=25°C	--	2.2	--	A	
Temperature Coefficient of Output Voltage	Δ Vout/ Δ Tj	Iout=5mA, 0°C ≤ Tj ≤ 125°C	--	-0.7	--	mV/°C	

• PJ7808B ELECTRICAL CHARACTERISTICS

($V_{in}=14V$, $I_{out}=500mA$, $0^{\circ}C \leq T_j \leq 125^{\circ}C$, $C_{in}=0.33 \mu F$, $C_{out}=0.1 \mu F$; unless otherwise specified.)

CHARACTERISTICS	SYMBOL	TEST CONDITIONS	MIN.	TYP.	MAX.	UNIT	
Output Voltage	Vout	Tj=25°C	7.69	8	8.32	V	
		10.5V ≤ Vin ≤ 23V, 5mA ≤ Iout ≤ 1A, PD ≤ 15W	7.61	8	8.40		
Line Regulation	REGline	Tj=25°C	10.5V ≤ Vin ≤ 25V	--	6	160	mV
			11V ≤ Vin ≤ 17V	--	2	80	mV
Load Regulation	REGload	Tj=25°C	10mA ≤ Iout ≤ 1A	--	12	160	mV
			250mA ≤ Iout ≤ 750mA	--	4	80	mV
Quiescent Current	Iq	Iout=0, Tj=25°C	--	4.3	8	mA	
Quiescent Current Change	Δ Iq	10.5V ≤ Vin ≤ 25V 5mA ≤ Iout ≤ 1A	--	--	1	mA	
			--	--	0.5	mA	
Output Noise Voltage	Vn	10Hz ≤ f ≤ 100KHz, Tj=25°C	--	52	--	μV	
Ripple Rejection Ratio	RR	f=120Hz, 11V ≤ Vin ≤ 21V	56	72	--	dB	
Voltage Drop	Vdrop	Iout=1.0A, Tj=25°C	--	2	--	V	
Output Resistance	Rout	f=1KHz	--	16	--	mΩ	
Output Short Circuit Current	Ios	Tj=25°C	--	450	--	mA	
Peak Output Current	Io peak	Tj=25°C	--	2.2	--	A	
Temperature Coefficient of Output Voltage	Δ Vout/ Δ Tj	Iout=5mA, 0°C ≤ Tj ≤ 125°C	--	-0.8	--	mV/°C	

* Pulse testing techniques are used to maintain the junction temperature as close to the ambient temperature as possible, and thermal effects must be taken into account separately.

** This specification applies only for DC power dissipation permitted by absolute maximum ratings.

3-Terminal Fixed Voltage Positive Regulators

• PJ7809B ELECTRICAL CHARACTERISTICS

($V_{in}=15V$, $I_{out}=500mA$, $0^{\circ}C \leq T_j \leq 125^{\circ}C$, $C_{in}=0.33 \mu F$, $C_{out}=0.1 \mu F$; unless otherwise specified.)

CHARACTERISTICS	SYMBOL	TEST CONDITIONS	MIN.	TYP.	MAX.	UNIT	
Output Voltage	Vout	Tj=25°C	8.65	9	9.36	V	
		10.5V ≤ Vin ≤ 23V, 5mA ≤ Iout ≤ 1A, PD ≤ 15W	8.57	9	9.45		
Line Regulation	REGline	Tj=25°C	11.5V ≤ Vin ≤ 26V	--	6	180	mV
			11.5V ≤ Vin ≤ 17V	--	2	90	mV
Load Regulation	REGload	Tj=25°C	5mA ≤ Iout ≤ 1A	--	12	180	mV
			250mA ≤ Iout ≤ 750mA	--	4	90	mV
Quiescent Current	Iq	Iout=0, Tj=25°C	--	4.3	8	mA	
Quiescent Current Change	ΔIq	11.5V ≤ Vin ≤ 26V	--	--	1	mA	
		5mA ≤ Iout ≤ 1A	--	--	0.5	mA	
Output Noise Voltage	Vn	10Hz ≤ f ≤ 100KHz, Tj=25°C	--	52	--	μV	
Ripple Rejection Ratio	RR	f=120Hz, 11.5V ≤ Vin ≤ 21.5V	55	72	--	dB	
Voltage Drop	Vdrop	Iout=1.0A, Tj=25°C	--	2	--	V	
Output Resistance	Rout	f=1KHz	--	16	--	mΩ	
Output Short Circuit Current	Ios	Tj=25°C	--	450	--	mA	
Peak Output Current	Io peak	Tj=25°C	--	2.2	--	A	
Temperature Coefficient of Output Voltage	ΔVout/ΔTj	Iout=5mA, 0°C ≤ Tj ≤ 125°C	--	-1	--	mV/°C	

• PJ7810B ELECTRICAL CHARACTERISTICS

($V_{in}=16V$, $I_{out}=500mA$, $0^{\circ}C \leq T_j \leq 125^{\circ}C$, $C_{in}=0.33 \mu F$, $C_{out}=0.1 \mu F$; unless otherwise specified.)

CHARACTERISTICS	SYMBOL	TEST CONDITIONS	MIN.	TYP.	MAX.	UNIT	
Output Voltage	Vout	Tj=25°C	9.6	10	10.4	V	
		12.5V ≤ Vin ≤ 25V, 5mA ≤ Iout ≤ 1A, PD ≤ 15W	9.5	10	10.5		
Line Regulation	REGline	Tj=25°C	12.5V ≤ Vin ≤ 28V	--	7	200	mV
			13V ≤ Vin ≤ 17V	--	2	100	mV
Load Regulation	REGload	Tj=25°C	10mA ≤ Iout ≤ 1A	--	12	200	mV
			250mA ≤ Iout ≤ 750mA	--	4	100	mV
Quiescent Current	Iq	Iout=0, Tj=25°C	--	4.3	8	mA	
Quiescent Current Change	ΔIq	12.5V ≤ Vin ≤ 28V	--	--	1	mA	
		5mA ≤ Iout ≤ 1A	--	--	0.5	mA	
Output Noise Voltage	Vn	10Hz ≤ f ≤ 100KHz, Tj=25°C	--	70	--	μV	
Ripple Rejection Ratio	RR	f=120Hz, 13V ≤ Vin ≤ 23V	55	71	--	dB	
Voltage Drop	Vdrop	Iout=1.0A, Tj=25°C	--	2	--	V	
Output Resistance	Rout	f=1KHz	--	18	--	mΩ	
Output Short Circuit Current	Ios	Tj=25°C	--	400	--	mA	
Peak Output Current	Io peak	Tj=25°C	--	2.2	--	A	
Temperature Coefficient of Output Voltage	ΔVout/ΔTj	Iout=5mA, 0°C ≤ Tj ≤ 125°C	--	-1	--	mV/°C	

* Pulse testing techniques are used to maintain the junction temperature as close to the ambient temperature as possible, and thermal effects must be taken into account separately.

** This specification applies only for DC power dissipation permitted by absolute maximum ratings.

3-Terminal Fixed Voltage Positive Regulators

• PJ7812B ELECTRICAL CHARACTERISTICS

V_{in}=19V, I_{out}=500mA, 0°C≤T_j≤125°C, C_{in}=0.33 μF, C_{out}=0.1 μF; unless otherwise specified.)

CHARACTERISTICS	SYMBOL	TEST CONDITIONS	MIN.	TYP.	MAX.	UNIT	
Output Voltage	V _{out}	T _j =25°C	11.53	12	12.48	V	
		14.5V≤V _{in} ≤27V, 5mA≤I _{out} ≤1A, PD ≤15W	11.42	12	12.60		
Line Regulation	REG _{line}	T _j =25°C	14V≤V _{in} ≤30V	--	10	240	mV
			15V≤V _{in} ≤19V	--	3	120	mV
Load Regulation	REG _{load}	T _j =25°C	10mA≤I _{out} ≤1A	--	12	240	mV
			250mA≤I _{out} ≤750mA	--	4	120	mV
Quiescent Current	I _q	T _j =25°C, I _{out} =0	--	4.3	8	mA	
Quiescent Current Change	ΔI _q	14.5V≤V _{in} ≤30V	--	--	1	mA	
		5mA≤I _{out} ≤1A	--	--	0.5	mA	
Output Noise Voltage	V _n	10Hz≤f≤100KHz, T _j =25°C	--	75	--	μV	
Ripple Rejection Ratio	RR	f=120Hz, 15V≤V _{in} ≤25V	55	71	--	dB	
Voltage Drop	V _{drop}	I _{out} =1.0A, T _j =25°C	--	2	--	V	
Output Resistance	R _{out}	f=1KHz	--	18	--	mΩ	
Output Short Circuit Current	I _{os}	T _j =25°C	--	350	--	mA	
Peak Output Current	I _{o peak}	T _j =25°C	--	2.2	--	A	
Temperature Coefficient of Output Voltage	ΔV _{out} /ΔT _j	I _{out} =5mA, 0°C≤T _j ≤125°C	--	-1	--	mV/°C	

• PJ7815B ELECTRICAL CHARACTERISTICS

(V_{in}=23V, I_{out}=500mA, 0°C≤T_j≤125°C, C_{in}=0.33 μF, C_{out}=0.1 μF; unless otherwise specified.)

CHARACTERISTICS	SYMBOL	TEST CONDITIONS	MIN.	TYP.	MAX.	UNIT	
Output Voltage	V _{out}	T _j =25°C	14.42	15	15.60	V	
		17.5V≤V _{in} ≤30V, 5mA≤I _{out} ≤1A, PD ≤15W	14.28	15	15.75		
Line Regulation	REG _{line}	T _j =25°C	17.5V≤V _{in} ≤30V	--	12	300	mV
			18V≤V _{in} ≤22V	--	3	150	mV
Load Regulation	REG _{load}	T _j =25°C	10mA≤I _{out} ≤1A	--	12	300	mV
			250mA≤I _{out} ≤750mA	--	4	150	mV
Quiescent Current	I _q	T _j =25°C, I _{out} =0	--	4.3	8	mA	
Quiescent Current Change	ΔI _q	17.5V≤V _{in} ≤30V	--	--	1	mA	
		5mA≤I _{out} ≤1A	--	--	0.5	mA	
Output Noise Voltage	V _n	10Hz≤f≤100KHz, T _j =25°C	--	90	--	μV	
Ripple Rejection Ratio	RR	f=120Hz, 18V≤V _{in} ≤28V	54	70	--	dB	
Voltage Drop	V _{drop}	I _{out} =1.0A, T _j =25°C	--	2	--	V	
Output Resistance	R _{out}	f=1KHz	--	19	--	mΩ	
Output Short Circuit Current	I _{os}	T _j =25°C	--	230	--	mA	
Peak Output Current	I _{o peak}	T _j =25°C	--	2.2	--	A	
Temperature Coefficient of Output Voltage	ΔV _{out} /ΔT _j	I _{out} =5mA, 0°C≤T _j ≤125°C	--	-1	--	mV/°C	

* Pulse testing techniques are used to maintain the junction temperature as close to the ambient temperature as possible, and thermal effects must be taken into account separately.

** This specification applies only for DC power dissipation permitted by absolute maximum ratings.

3-Terminal Fixed Voltage Positive Regulators

• PJ7818B ELECTRICAL CHARACTERISTICS

($V_{in}=27V$, $I_{out}=500mA$, $0^{\circ}C \leq T_j \leq 125^{\circ}C$, $C_{in}=0.33 \mu F$, $C_{out}=0.1 \mu F$; unless otherwise specified.)

CHARACTERISTICS	SYMBOL	TEST CONDITIONS	MIN.	TYP.	MAX.	UNIT	
Output Voltage	V_{out}	$T_j=25^{\circ}C$	17.30	18	18.72	V	
		$21V \leq V_{in} \leq 33V$, $5mA \leq I_{out} \leq 1A$, $PD \leq 15W$	17.14	18	18.90		
Line Regulation	REG _{line}	$T_j=25^{\circ}C$	$21V \leq V_{in} \leq 33V$	--	15	360	mV
			$22V \leq V_{in} \leq 26V$	--	5	180	mV
Load Regulation	REG _{load}	$T_j=25^{\circ}C$	$10mA \leq I_{out} \leq 1A$	--	12	360	mV
			$250mA \leq I_{out} \leq 750mA$	--	4	180	mV
Quiescent Current	I_q	$T_j=25^{\circ}C$, $I_{out}=0$	--	4.5	8	mA	
Quiescent Current Change	ΔI_q	$21V \leq V_{in} \leq 33V$	--	--	1	mA	
		$5mA \leq I_{out} \leq 1A$	--	--	0.5	mA	
Output Noise Voltage	V_n	$10Hz \leq f \leq 100KHz$, $T_j=25^{\circ}C$	--	110	--	μV	
Ripple Rejection Ratio	RR	$f=120Hz$, $21V \leq V_{in} \leq 31V$	54	70	--	dB	
Voltage Drop	V_{drop}	$I_{out}=1.0A$, $T_j=25^{\circ}C$	--	2	--	V	
Output Resistance	R_{out}	$f=1KHz$	--	22	--	$m\Omega$	
Output Short Circuit Current	I_{os}	$T_j=25^{\circ}C$	--	200	--	mA	
Peak Output Current	$I_{o peak}$	$T_j=25^{\circ}C$	--	2.2	--	A	
Temperature Coefficient of Output Voltage	$\Delta V_{out} / \Delta T_j$	$I_{out}=5mA$, $0^{\circ}C \leq T_j \leq 125^{\circ}C$	--	-1	--	$mV/^{\circ}C$	

• PJ7824B BELECTRICAL CHARACTERISTICS

($V_{in}=33V$, $I_{out}=500mA$, $0^{\circ}C \leq T_j \leq 125^{\circ}C$, $C_{in}=0.33 \mu F$, $C_{out}=0.1 \mu F$; unless otherwise specified.)

CHARACTERISTICS	SYMBOL	TEST CONDITIONS	MIN.	TYP.	MAX.	UNIT	
Output Voltage	V_{out}	$T_j=25^{\circ}C$	23.07	24	24.96	V	
		$26V \leq V_{in} \leq 38V$, $5mA \leq I_{out} \leq 1A$, $PD \leq 15W$	22.85	24	25.20		
Line Regulation	REG _{line}	$T_j=25^{\circ}C$	$26V \leq V_{in} \leq 38V$	--	18	480	mV
			$27V \leq V_{in} \leq 32V$	--	6	240	mV
Load Regulation	REG _{load}	$T_j=25^{\circ}C$	$10mA \leq I_{out} \leq 1A$	--	12	480	mV
			$250mA \leq I_{out} \leq 750mA$	--	4	240	mV
Quiescent Current	I_q	$I_{out}=0$, $T_j=25^{\circ}C$	--	4.6	8	mA	
Quiescent Current Change	ΔI_q	$26V \leq V_{in} \leq 38V$	--	--	1	mA	
		$5mA \leq I_{out} \leq 1A$	--	--	0.5	mA	
Output Noise Voltage	V_n	$10Hz \leq f \leq 100KHz$, $T_j=25^{\circ}C$	--	170	--	μV	
Ripple Rejection Ratio	RR	$f=120Hz$, $26V \leq V_{in} \leq 36V$	54	70	--	dB	
Voltage Drop	V_{drop}	$I_{out}=1.0A$, $T_j=25^{\circ}C$	--	2	--	V	
Output Resistance	R_{out}	$f=1KHz$	--	28	--	$m\Omega$	
Output Short Circuit Current	I_{os}	$T_j=25^{\circ}C$	--	150	--	mA	
Peak Output Current	$I_{o peak}$	$T_j=25^{\circ}C$	--	2.2	--	A	
Temperature Coefficient of Output Voltage	$\Delta V_{out} / \Delta T_j$	$I_{out}=5mA$, $0^{\circ}C \leq T_j \leq 125^{\circ}C$	--	-1.5	--	$mV/^{\circ}C$	

* Pulse testing techniques are used to maintain the junction temperature as close to the ambient temperature as possible, and thermal effects must be taken into account separately.

** This specification applies only for DC power dissipation permitted by absolute maximum ratings.

3-Terminal Fixed Voltage Positive Regulators

FIGURE 1 - WORST CASE POWER DISSIPATION versus AMBIENT TEMPERATURE

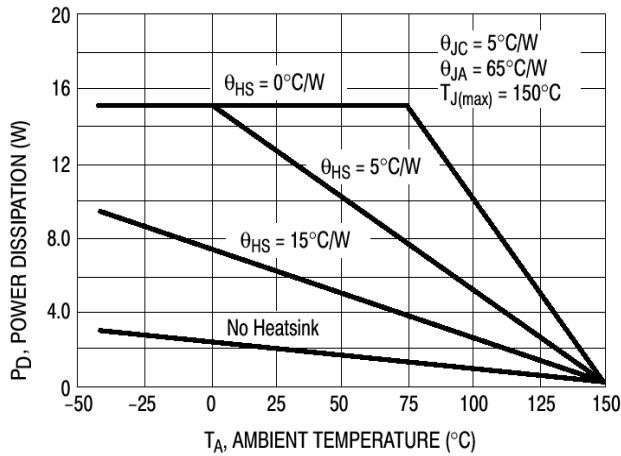

FIGURE 2 - PEAK OUTPUT CURRENT AS A FUNCTION OF INPUT-OUTPUT DIFFERENTIAL VOLTAGE

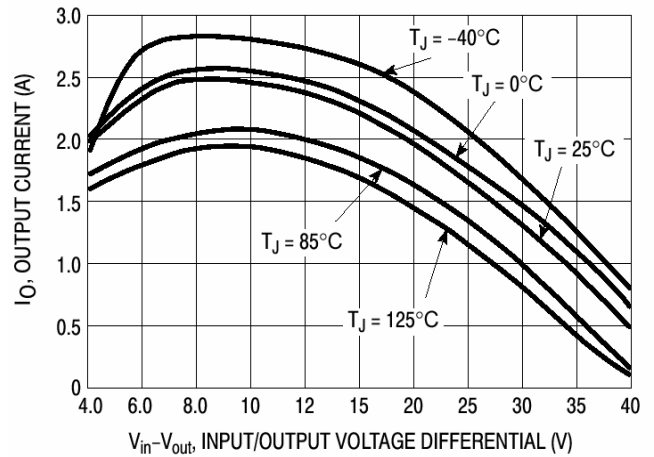

FIGURE 3 - QUIESCENT CURRENT AS A FUNCTION OF TEMPERATURE

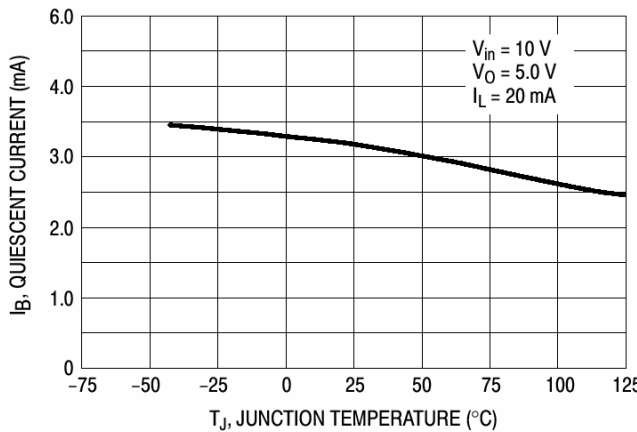

FIGURE 4 - INPUT OUTPUT DIFFERENTIAL AS A FUNCTION OF JUNCTION TEMPERATURE

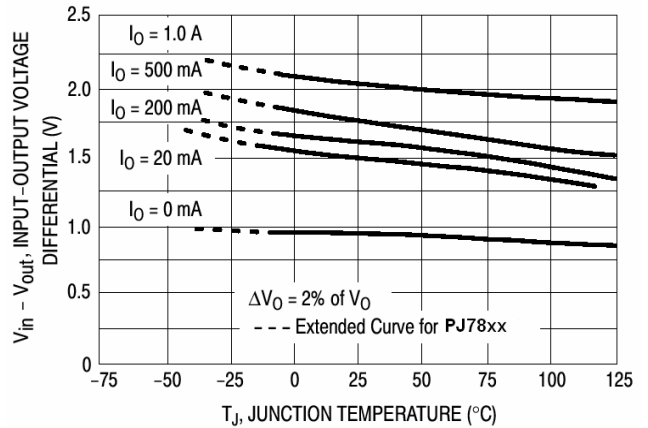

FIGURE 5 - OUTPUT VOLTAGE AS A FUNCTION OF JUNCTION TEMPERATURE

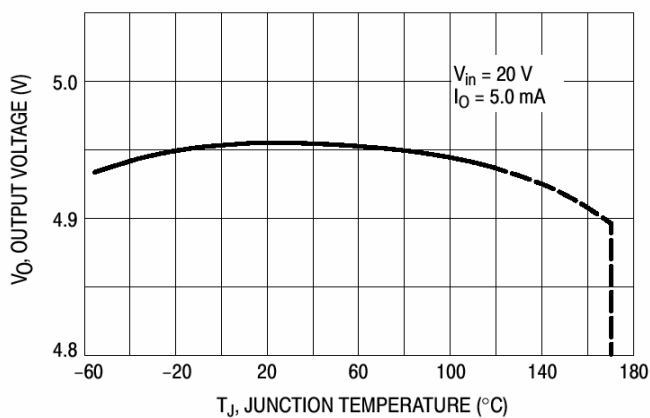
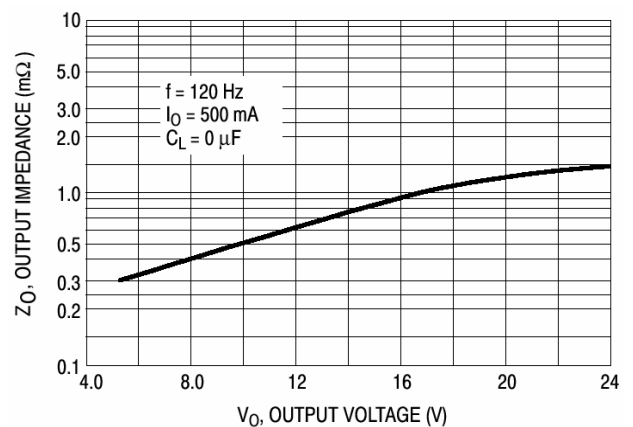

FIGURE 6 - OUTPUT IMPEDANCE AS A FUNCTION OF OUTPUT VOLTAGE



3-Terminal Fixed Voltage Positive Regulators

FIGURE 7 - RIPPLE REJECTION AS A FUNCTION OF OUTPUT VOLTAGE

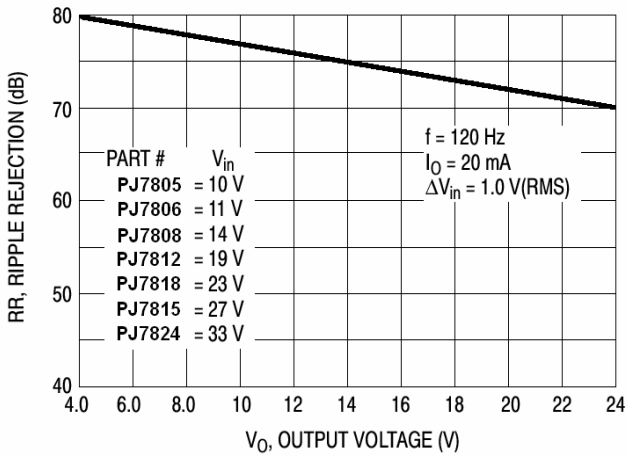
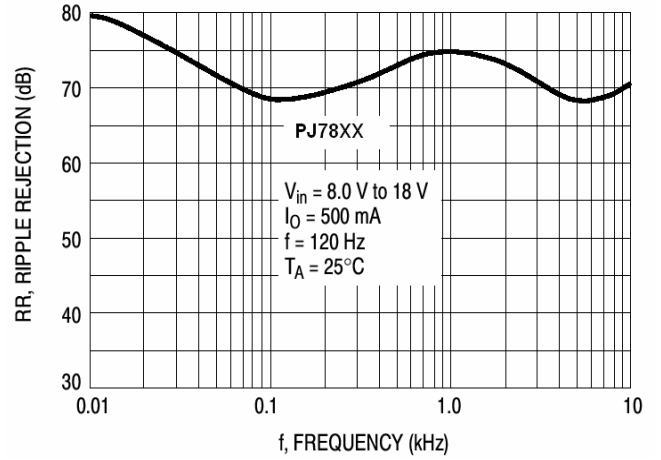
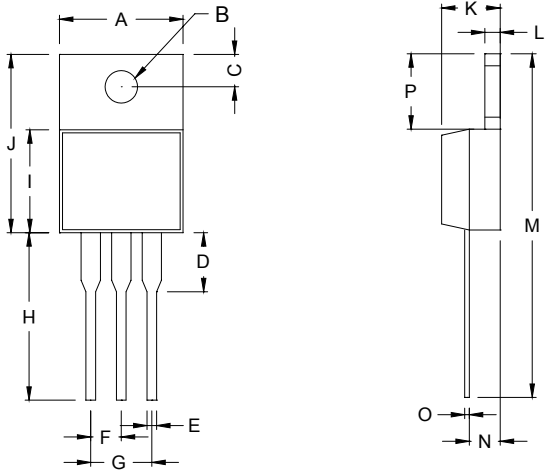

FIGURE 8 - RIPPLE REJECTION AS A FUNCTION OF FREQUENCY



3-Terminal Fixed Voltage Positive Regulators

TO-220 Unit : mm



TO-220 DIMENSION				
DIM	MILLIMETERS		INCHES	
	MIN	MAX	MIN	MAX
A	10.000	10.500	0.394	0.413
B	3.240	4.440	0.128	0.175
C	2.440	2.940	0.096	0.116
D	-	6.350	-	0.250
E	0.381	1.106	0.015	0.040
F	2.345	2.715	0.092	0.058
G	4.690	5.430	0.092	0.107
H	12.700	14.732	0.500	0.581
I	8.382	9.017	0.330	0.355
J	14.224	16.510	0.560	0.650
K	3.556	4.826	0.140	0.190
L	0.508	1.397	0.020	0.055
M	27.700	29.620	1.060	1.230
N	2.032	2.921	0.080	0.115
O	0.255	0.610	0.010	0.024
P	5.842	6.858	0.230	0.270

TO-220F Unit : mm

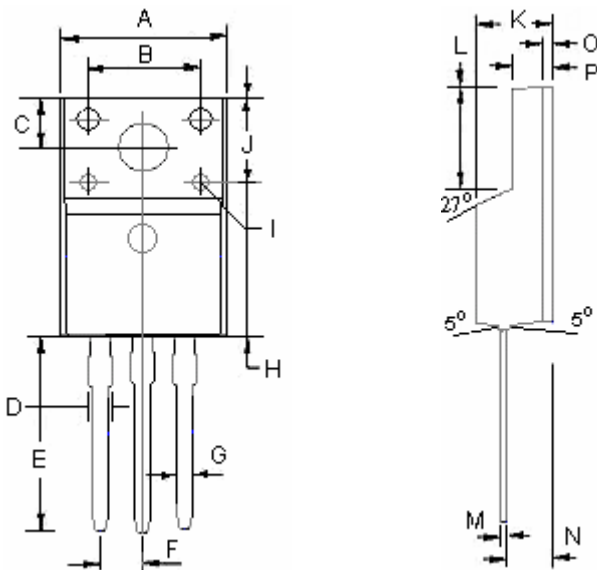

TO-220F DIMENSION				
DIM	MILLIMETERS		INCHES	
	MIN	MAX	MIN	MAX
A	9.960	10.36	0.392	0.408
B	6.800	7.200	0.268	0.283
C	3.100	3.500	0.122	0.138
D	1.470		0.059	
E	12.60	13.00	0.496	0.512
F	2.340	2.740	0.092	0.108
G	0.600	1.000	0.024	0.039
H	15.67	16.07	0.617	0.633
I	2-Ø1.0 DEEP 0.10		-	
J	5.400		0.212	
K	4.500	4.900	0.177	0.193
L	6.480	0.680	0.255	0.262
M	0.450	0.600	0.017	0.023
N	2.560	2.960	0.100	0.166
O	0.700		0.027	
P	2.340	2.740	0.092	0.107