



PJP10N65 / PJF10N65

650V N-Channel Enhancement Mode MOSFET

TO-220AB / ITO-220AB

FEATURES

- 10A , 650V, $R_{DS(ON)}=1.0\Omega@V_{GS}=10V, I_D=5.0A$
- Low ON Resistance
- Fast Switching
- Low Gate Charge
- Fully Characterized Avalanche Voltage and Current
- Specially Designed for AC Adapter, Battery Charge and SMPS
- In compliance with EU RoHs 2002/95/EC Directives

MECHANICAL DATA

- Case: TO-220AB / ITO-220AB Molded Plastic
- Terminals : Solderable per MIL-STD-750,Method 2026

ORDERING INFORMATION

TYPE	MARKING	PACKAGE	PACKING
PJP10N65	P10N65	TO-220AB	50PCS/TUBE
PJF10N65	F10N65	ITO-220AB	50PCS/TUBE

TO-220AB

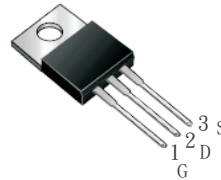

ITO-220AB

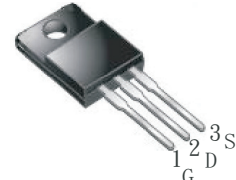

INTERNAL SCHEMATIC DIAGRAM

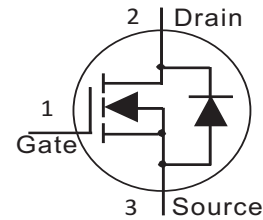

Maximum RATINGS and Thermal Characteristics ($T_A=25^\circ\text{C}$ unless otherwise noted)

PARAMETER	Symbol	PJP10N65	PJF10N65	Units
Drain-Source Voltage	V_{DS}	650		V
Gate-Source Voltage	V_{GS}	± 30		V
Continuous Drain Current	I_D	10	10	A
Pulsed Drain Current ¹⁾	I_{DM}	40	40	A
Maximum Power Dissipation Derating Factor	P_D	156 1.25	50 0.4	W
Operating Junction and Storage Temperature Range	T_J, T_{STG}	-55 to +150		$^\circ\text{C}$
Avalanche Energy with Single Pulse $I_{AS}=10A, V_{DD}=90V, L=13mH$	E_{AS}	750		mJ
Junction-to-Case Thermal Resistance	$R_{\theta JC}$	0.8	2.5	$^\circ\text{C/W}$
Junction-to Ambient Thermal Resistance	$R_{\theta JA}$	62.5	100	$^\circ\text{C/W}$

Note : 1. Maximum DC current limited by the package

PAN JIT RESERVES THE RIGHT TO IMPROVE PRODUCT DESIGN,FUNCTIONS AND RELIABILITY WITHOUT NOTICE



PJP10N65 / PJF10N65

ELECTRICAL CHARACTERISTICS (T_A=25°C unless otherwise noted)

Parameter	Symbol	Test Condition	Min.	Typ.	Max.	Units
Static						
Drain-Source Breakdown Voltage	BV _{DSS}	V _{GS} =0V, I _D =250uA	650	-	-	V
Gate Threshold Voltage	V _{GS(th)}	V _{DS} =V _{GS} , I _D =250uA	2.0	-	4.0	V
Drain-Source On-State Resistance	R _{DS(on)}	V _{GS} =10V, I _D =5.0A	-	0.85	1.0	Ω
Zero Gate Voltage Drain Current	I _{DSS}	V _{DS} =650V, V _{GS} =0V	-	-	10	uA
Gate Body Leakage	I _{GSS}	V _{GS} =±30V, V _{DS} =0V	-	-	±100	nA
Dynamic						
Total Gate Charge	Q _g	V _{DS} =520V, I _D =10A, V _{GS} =10V	-	38.6	52	nC
Gate-Source Charge	Q _{gs}		-	8.4	-	
Gate-Drain Charge	Q _{gd}		-	9.8	-	
Turn-On Delay Time	t _{d(on)}	V _{DD} =325V, I _D =10A V _{GS} =10V, R _G =25Ω	-	14.8	22	ns
Turn-On Rise Time	t _r		-	22.6	36	
Turn-Off Delay Time	t _{d(off)}		-	48.2	90	
Turn-Off Fall Time	t _f		-	26.8	42	
Input Capacitance	C _{iss}	V _{DS} =25V, V _{GS} =0V f=1.0MHz	-	1450	2020	pF
Output Capacitance	C _{oss}		-	120	165	
Reverse Transfer Capacitance	C _{rss}		-	12	16	
Source-Drain Diode						
Max. Diode Forward Current	I _S	-	-	-	10	A
Max.Pulsed Source Current	I _{SM}	-	-	-	40	A
Diode Forward Voltage	V _{SD}	I _S =10A, V _{GS} =0V	-	-	1.4	V
Reverse Recovery Time	t _{rr}	V _{GS} =0V, I _F =10A di/dt=100A/us	-	450	-	ns
Reverse Recovery Charge	Q _{rr}		-	4.2	-	uC

NOTE : Plus Test : Pluse Width ≤ 300us, Duty Cycle ≤ 2%.



PJP10N65 / PJF10N65

Typical Characteristics Curves ($T_a=25^\circ\text{C}$, unless otherwise noted)

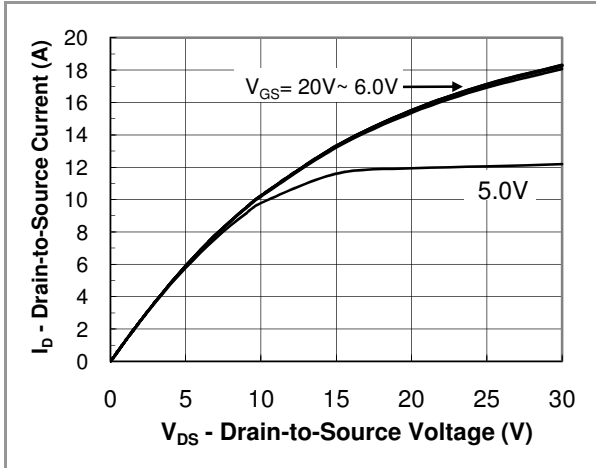

Fig.1 Output Characteristic

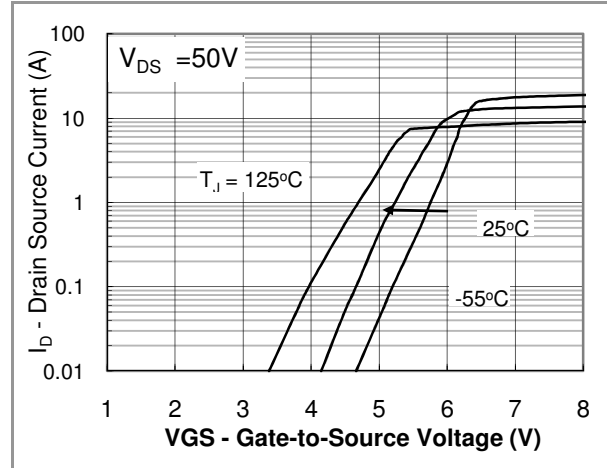

Fig.2 Transfer Characteristic

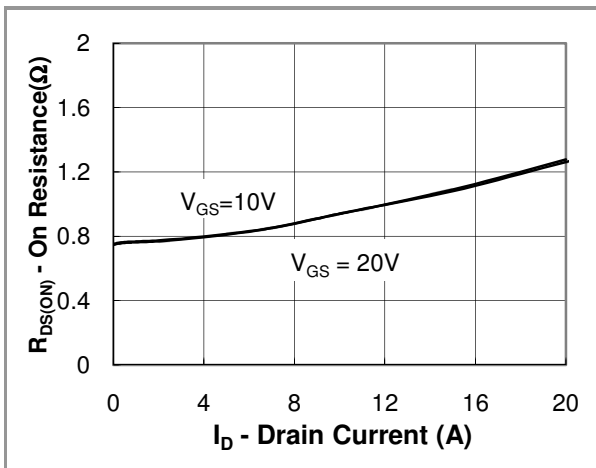

Fig.3 On Resistance vs Drain Current

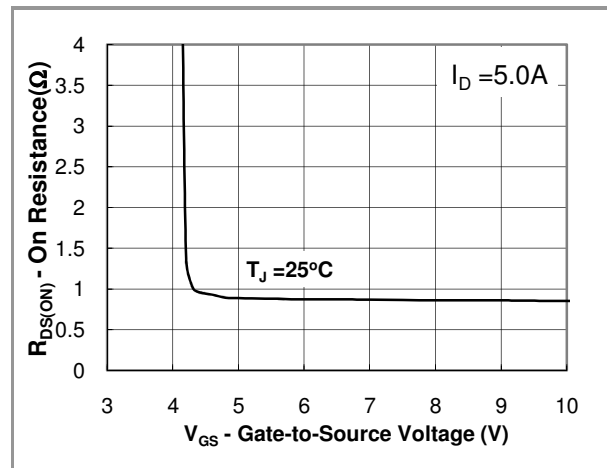

Fig.4 On Resistance vs Gate to Source Voltage

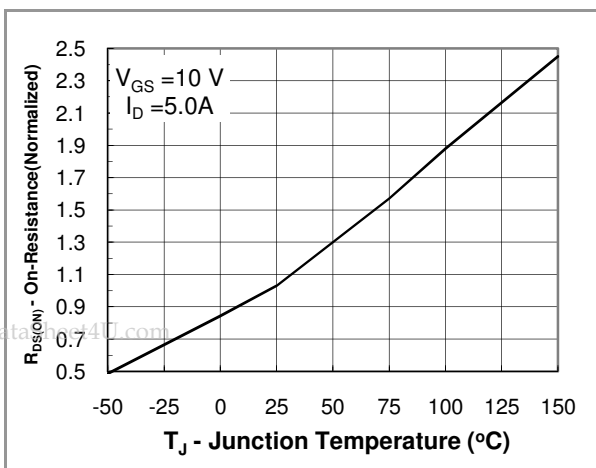

Fig.5 On Resistance vs Junction Temperature

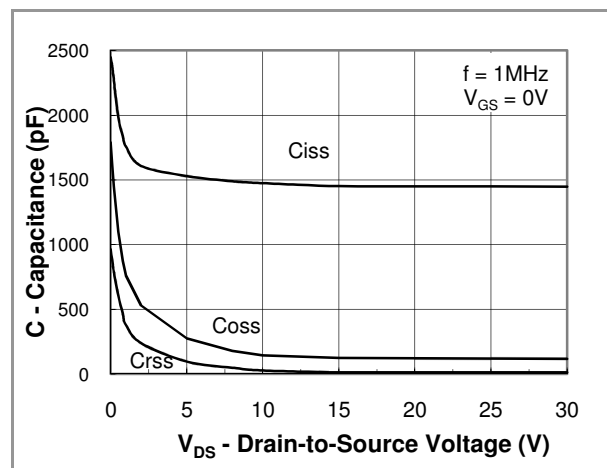

Fig.6 Capacitance



PJP10N65 / PJF10N65

Typical Characteristics Curves ($T_a=25^\circ\text{C}$, unless otherwise noted)

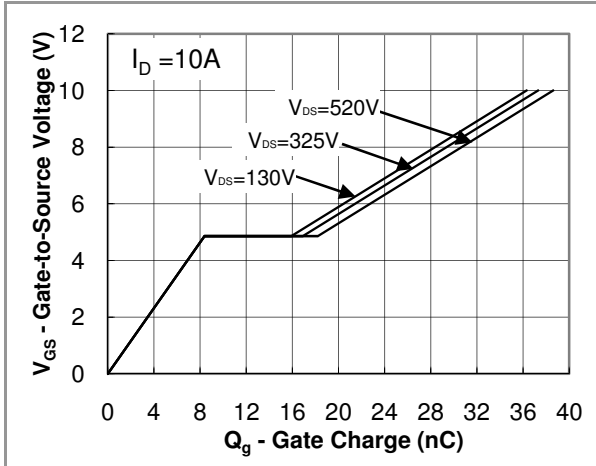

Fig. 7 Gate Charge Waveform

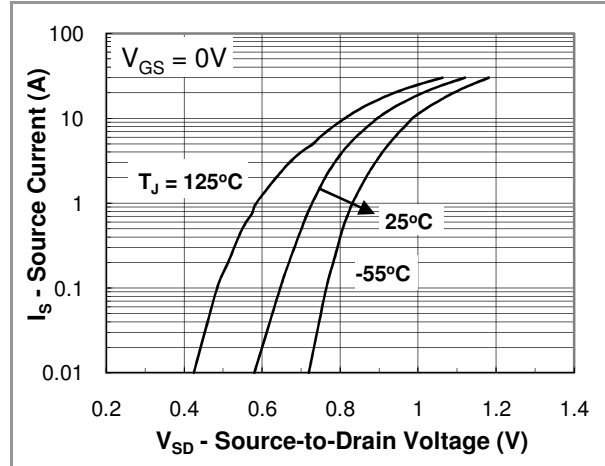

Fig.8 Source-Drain Diode Forward Voltage

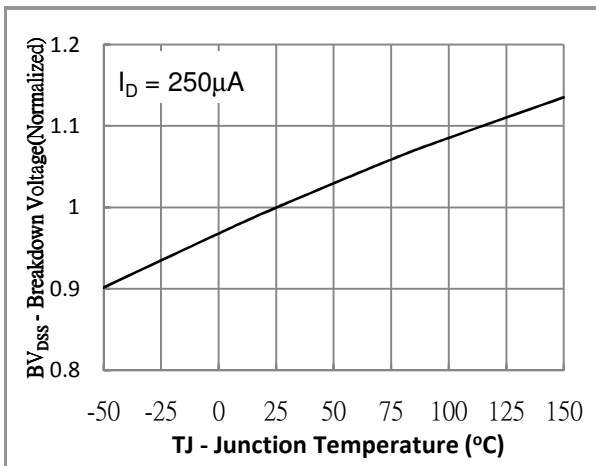

Fig.9 Breakdown Voltage vs Junction Temperature



PJP10N65 / PJF10N65

LEGALSTATEMENT

Copyright PanJit International, Inc 2010

The information presented in this document is believed to be accurate and reliable. The specifications and information herein are subject to change without notice. Pan Jit makes no warranty, representation or guarantee regarding the suitability of its products for any particular purpose. Pan Jit products are not authorized for use in life support devices or systems. Pan Jit does not convey any license under its patent rights or rights of others.

HALOGEN FREE PRODUCT DECLARATION

(Use green molding compound:ELER-8)

1. Pan Jit can produce halogen free product use molding compound for packing from Mar.2008 that contain Br<700 ppm,Cl<700ppm, Br+Cl<1000ppm,Sb₂O₃<100ppm.
2. If your company need halogen free product shall be note requirement green compound material on order for the halogen free product request.