



PJSD05CTS

BI-DIRECTIONAL ESD PROTECTION DIODE

This Penta has been designed to Protect Sensitive Equipment against ESD and to prevent Latch-Up events in CMOS circuitry operating at 5Vdc and below. This offers an integrated solution to protect up to data line where the board space is a premium.

SPECIFICATION FEATURES

- 100W Power Dissipation (8/20 μ s Waveform)
- Low Leakage Current, Maximum of 0.5 μ A@5Vdc
- Very low Clamping voltage
- IEC 61000-4-2 ESD 15kV air, 8kV Contact Compliance
- In compliance with EU RoHS 2002/95/EC directivess

APPLICATIONS

- Video I/O ports protection
- Set Top Boxes
- Portable Instrumentation
- Case : SOD-523 plastic
- Terminals : Solderable per MIL-STD-750, Method 2026
- Approx Weight : 0.0014 grams
- Marking : RS

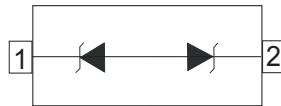
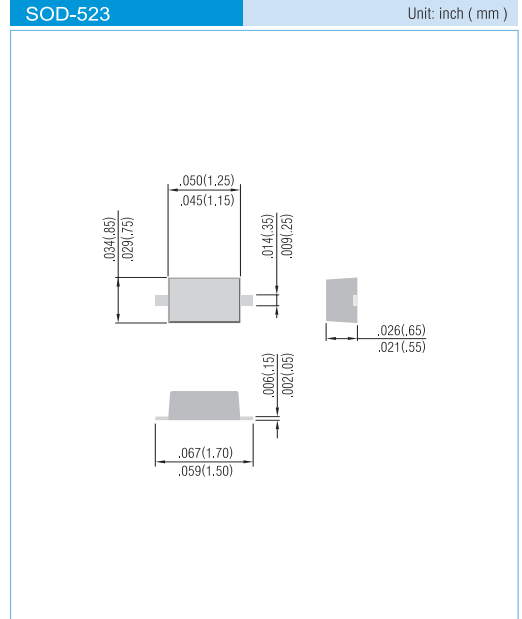

Fig.130



MAXIMUM RATINGS

Rating	Symbol	Value	Units
Peak Pulse Power (8/20 μ s Waveform)	P _{PP}	100	W
Peak Pulse Current (8/20 μ s Waveform)	I _{PP}	5.0	A
ESD Voltage (HBM)	V _{ESD}	>25	kV
Operating Junction and Storage Temperature Range	T _J , T _{STG}	-55 to 150	°C

ELECTRICAL CHARACTERISTICS (T_A=25°C)

Parameter	Symbol	Conditions	Min.	Typ.	Max.	Units
Reverse Stand-Off Voltage	V _{WRM}		-	-	5.0	V
Reverse Breakdown Voltage	V _{BR}	I _{BR} =1mA	5.78	-	7.82	V
Reverse Leakage Current	I _R	V _R =3.5V	-	-	0.5	μ A
Clamping Voltage (8/20 μ s)	V _C	I _{PP} =1A	-	-	12	V
Clamping Voltage (8/20 μ s)	V _C	I _{PP} =4A	-	-	15	V
Off State Junction Capacitance	C _J	0 Vdc Bias f=1MHz	-	-	30	pF
Off State Junction Capacitance	C _J	5 Vdc Bias f=1MHz	-	-	25	pF



PJSD05CTS

TYPICAL CHARACTERISTICS

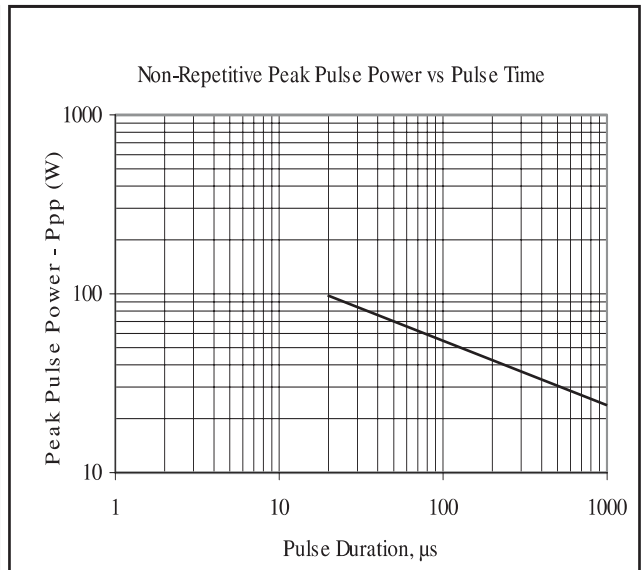
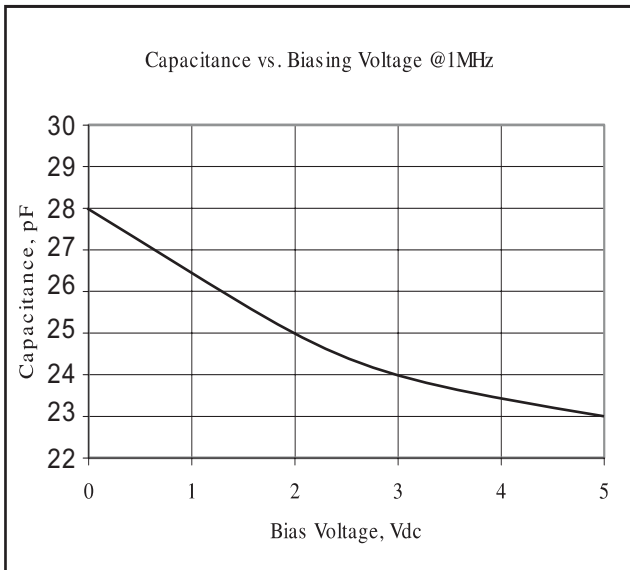
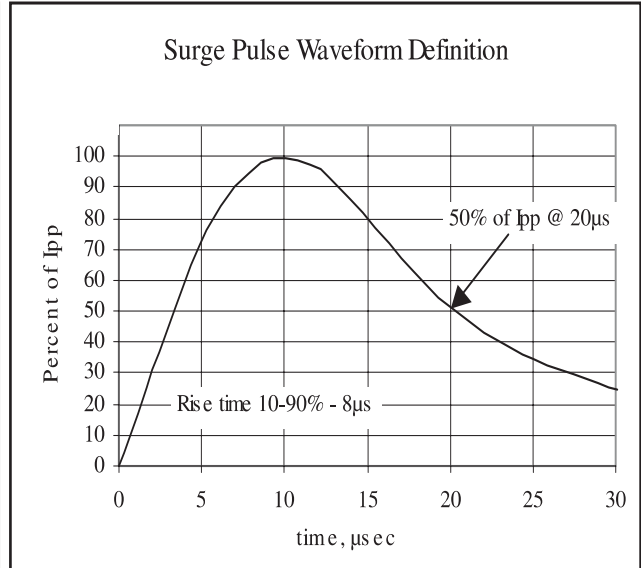
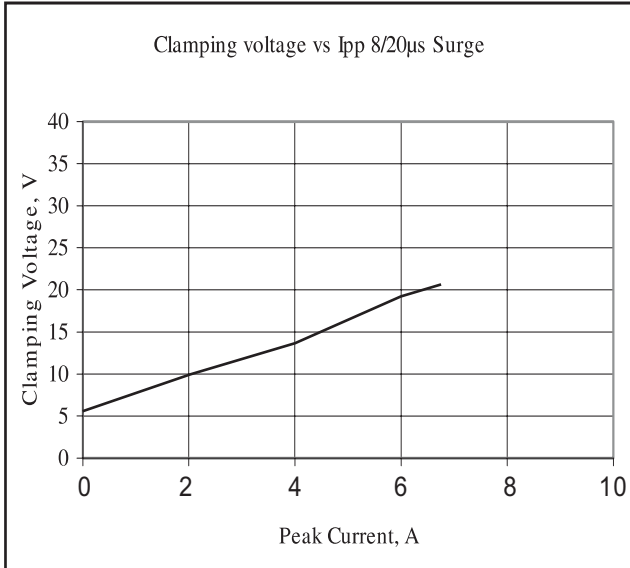



PJSD05CTS

MOUNTING PAD LAYOUT

SOD-523

Unit: inch (mm)

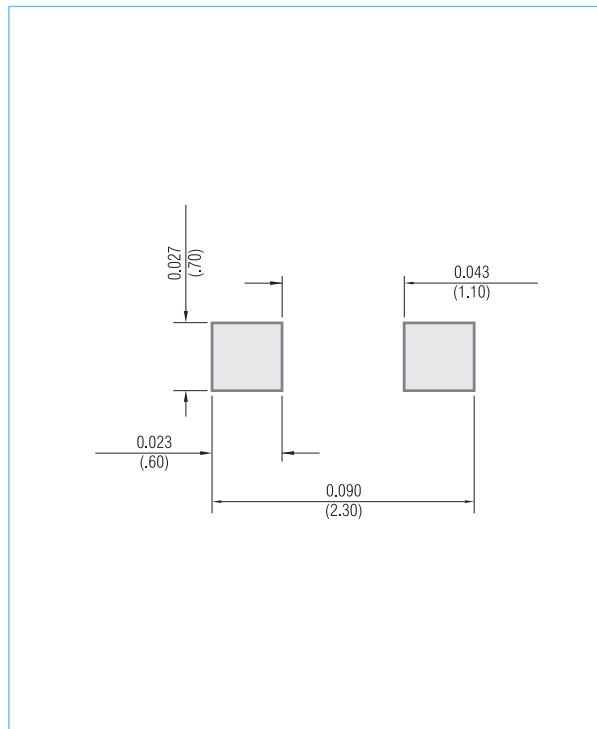

ORDER INFORMATION

- Packing information
 - T/R - 12K per 13" plastic Reel
 - T/R - 5K per 7" plastic Reel

LEGAL STATEMENT

Copyright PanJit International, Inc 2009

The information presented in this document is believed to be accurate and reliable. The specifications and information herein are subject to change without notice. Pan Jit makes no warranty, representation or guarantee regarding the suitability of its products for any particular purpose. Pan Jit products are not authorized for use in life support devices or systems. Pan Jit does not convey any license under its patent rights or rights of others.