

HEX TVS/ZENER ARRAY FOR ESD AND LATCH-UP PROTECTION

This 6 TVS/Zener Array family have been designed to Protect Sensitive Equipment against ESD and to prevent Latch-Up events in CMOS circuitry operating at 5V, 12V, 15V and 24V. This TVS array offers an integrated solution to protect up to 6 data lines where the board space is a premium.

SPECIFICATION FEATURES

- 350W Power Dissipation (8x20µsec Waveform)
- Low Leakage Current, Maximum of 5µA at rated voltage
- Very Low Clamping Voltage
- IEC61000-4-2 ESD 20kV air, 15kV Contact Compliance
- Packaged in the Industry Standard SOIC-8

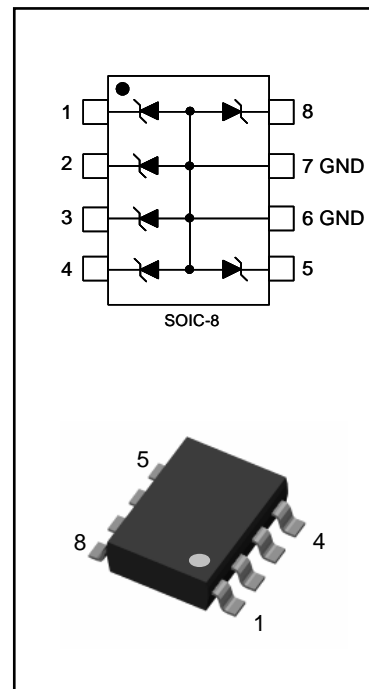

APPLICATIONS

- RS-232C or RS-422 Communication ports
- GPIB/IEEE 485 Ports
- Portable Instrumentation

MAXIMUM RATINGS (Per Device)

Rating	Symbol	Value	Units
Peak Pulse Power (8x20µsec Waveform)	P_{pp}	350	W
ESD Voltage (HBM)	V_{ESD}	>25	kV
Operating Temperature Range	T_J	-50 to +125	°C
Storage Temperature Range	T_{stg}	-50 to +150	°C

ELECTRICAL CHARACTERISTICS (Per Device) $T_J = 25^\circ\text{C}$

PJSMDA05-6

Parameter	Symbol	Conditions	Min	Typical	Max	Units
Reverse Stand-Off Voltage	V_{WRM}				5	V
Reverse Breakdown Voltage	V_{BR}	$I_{BR} = 1\text{mA}$	6			V
Reverse Leakage Current	I_R	$V_R = 5\text{V}$			5	µA
Clamping Voltage (8x20µsec)	V_{cl}	$I_{pp} = 5\text{A}$			9.8	V
Clamping Voltage (8x20µsec)	V_{cl}	$I_{pp} = 24\text{A}$			13	V
Off State Junction Capacitance	C_j	0 Vdc Bias $f = 1\text{MHz}$ Between I/O pins and pin 6, 7			225	pF
Off State Junction Capacitance	C_j	5 Vdc Bias $f = 1\text{MHz}$ Between I/O pins and pin 6, 7			125	pF



ELECTRICAL CHARACTERISTICS (Per Device) Tj = 25°C

PJSMDA12-6

Parameter	Symbol	Conditions	Min	Typical	Max	Units
Reverse Stand-Off Voltage	V_{WRM}				12	V
Reverse Breakdown Voltage	V_{BR}	$I_{BR} = 1mA$	13.3			V
Reverse Leakage Current	I_R	$V_R = 12V$			5	μA
Clamping Voltage (8x20 μ sec)	V_{cl}	$I_{pp} = 5A$			20	V
Clamping Voltage (8x20 μ sec)	V_{cl}	$I_{pp} = 15A$			25	V
Off State Junction Capacitance	C_j	0 Vdc Bias f = 1MHz Between I/O pins and pin 6, 7			100	pF

PJSMDA15-6

Parameter	Symbol	Conditions	Min	Typical	Max	Units
Reverse Stand-Off Voltage	V_{WRM}				15	V
Reverse Breakdown Voltage	V_{BR}	$I_{BR} = 1mA$	16.7			V
Reverse Leakage Current	I_R	$V_R = 15V$			5	μA
Clamping Voltage (8x20 μ sec)	V_{cl}	$I_{pp} = 5A$			24	V
Clamping Voltage (8x20 μ sec)	V_{cl}	$I_{pp} = 12A$			29	V
Off State Junction Capacitance	C_j	0 Vdc Bias f = 1MHz Between I/O pins and pin 6, 7			80	pF

PJSMDA24-6

Parameter	Symbol	Conditions	Min	Typical	Max	Units
Reverse Stand-Off Voltage	V_{WRM}				24	V
Reverse Breakdown Voltage	V_{BR}	$I_{BR} = 1mA$	26.7			V
Reverse Leakage Current	I_R	$V_R = 24V$			5	μA
Clamping Voltage (8x20 μ sec)	V_{cl}	$I_{pp} = 5A$			40	V
Clamping Voltage (8x20 μ sec)	V_{cl}	$I_{pp} = 8A$			44	V
Off State Junction Capacitance	C_j	0 Vdc Bias f = 1MHz Between I/O pins and pin 6, 7			60	pF



TYPICAL CHARACTERISTICS $T_J = 25^\circ\text{C}$ unless otherwise noted

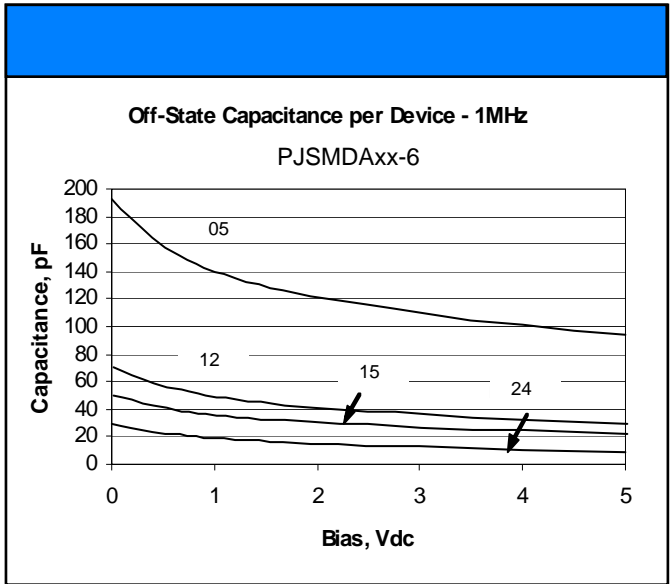
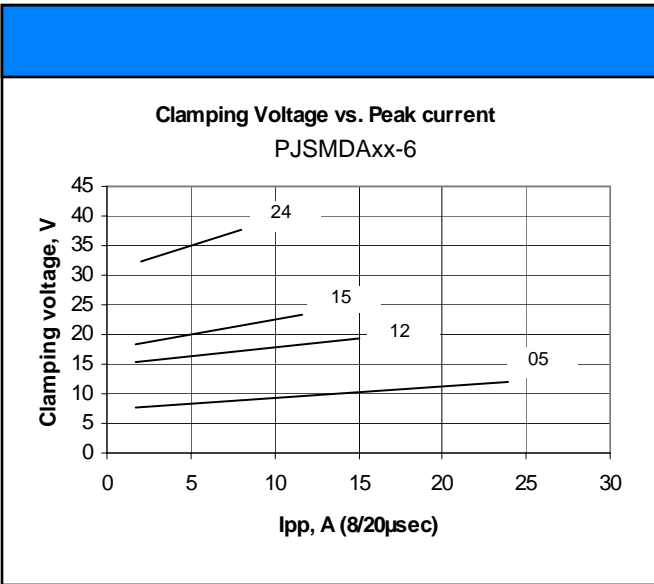
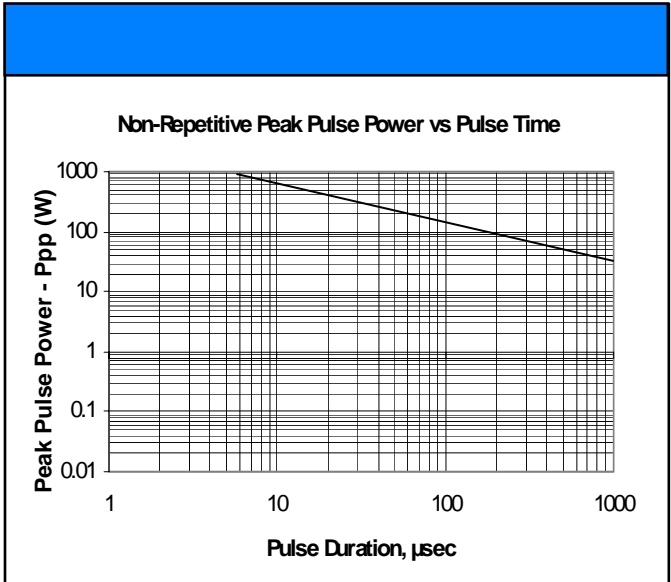
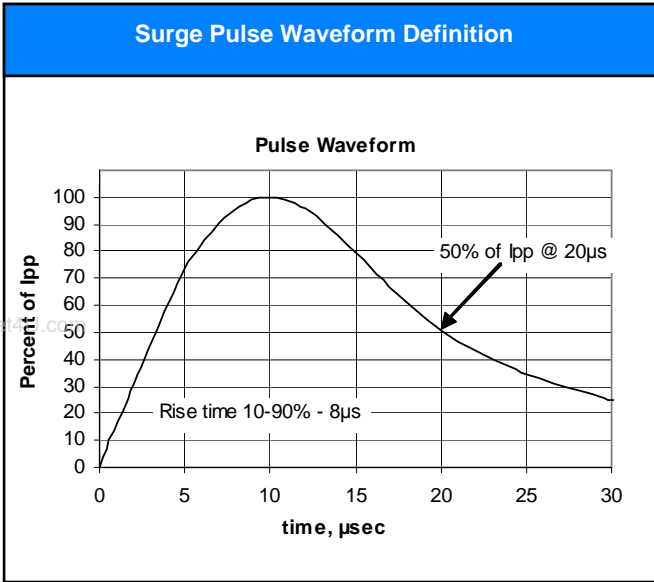

TYPICAL APPLICATION EXAMPLE AND PACKAGE DIMENSIONS

RS232 Pinout

Pin	Name	RS232	V.24	Dir	Description
1	CD	CF	109		Carrier Detect
2	RXD	BB	104		Receive Data
3	TXD	BA	103		Transmit Data
4	DTR	CD	108.2		Data Terminal Ready
5	GND	AB	102		System Ground
6	DSR	CC	107		Data Set Ready
7	RTS	CA	105		Request to Send
8	CTS	CB	106		Clear to Send
9	RI	CE	125		Ring Indicator

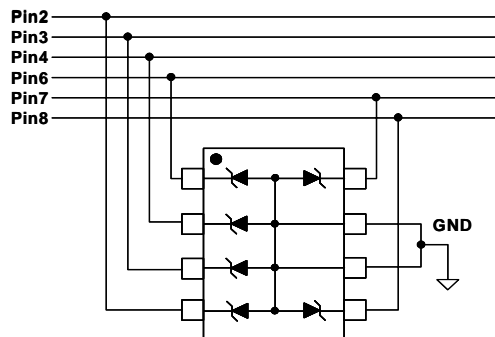

www.DataSheet4U.com

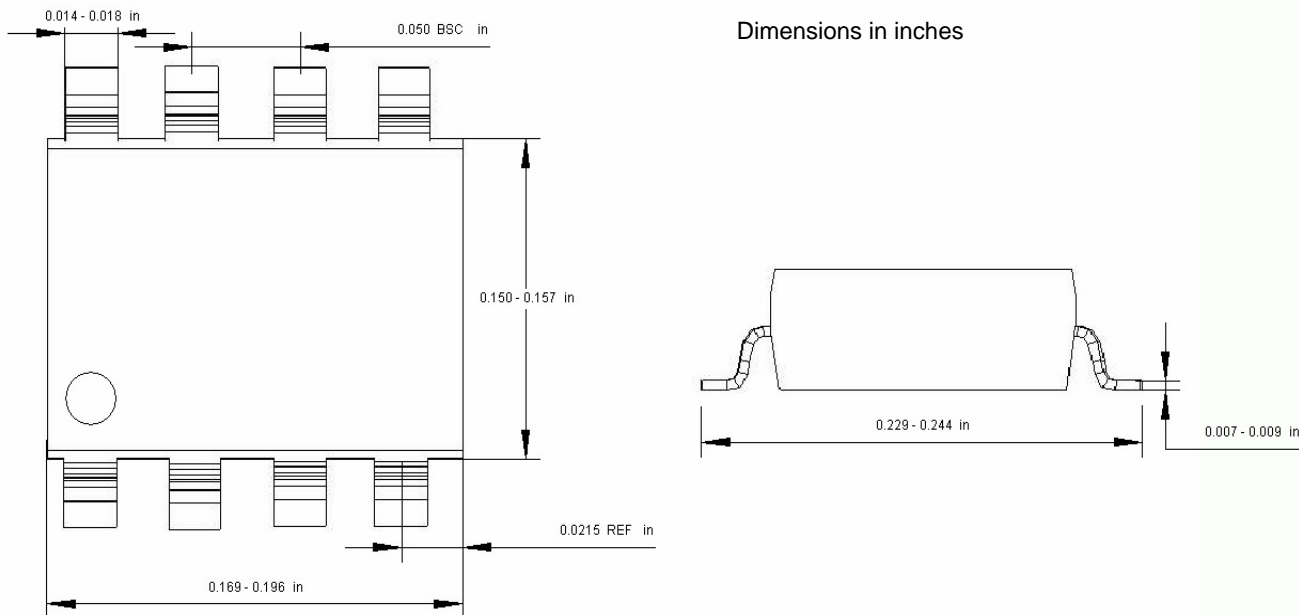

Dimensions in inches

