

50 W DC/DC power module 48 V input series

- Regulated single and dual outputs
- Efficiency >90% (3.3V) from 30% to full load
- Low profile 8.5 mm (0.335 in.)
- 1,500 Vdc isolation voltage
- MTBF >200 years at +75°C case temperature
- Full power up to +80°C ambient at 1 m/s airflow
- Complete, no extra filters or heatsinks required



The PKN 4000 I series of DC/DC power modules are intended to be used as distributed power sources in decentralized 48/60 VDC power systems. The PKN series use a ceramic substrate with thickfilm technology and a high degree of silicon integration. That together with the electrical design using synchronous rectification gives good thermal management, high reliability and high efficiency. The high efficiency, makes it possible to operate over a wide temperature range without a heatsink. At forced convection cooling >200 lfm (1 m/s), the PKN units can deliver full

power up to +80°C ambient temperature. The high reliability and the low profile of the PKN series makes them particularly suited for Information Technology and Telecom (IT&T) applications with board spacing down to 15 mm (0.6 in.).

These products are manufactured using highly automated manufacturing lines with a world-class quality commitment and a five-year warranty. Ericsson Microelectronics AB has been an ISO 9001 certified supplier since 1991. *For a complete product program please reference the back cover.*

General

Absolute Maximum Ratings

Characteristics		min	max	Unit
T _C	Case temperature @ max output power	-45	+100	°C
T _S	Storage temperature	-55	+125	°C
V _I	Input voltage	-0.5	+80	V dc
V _{ISO}	Isolation voltage (input to output test voltage)	1500		V dc
V _{LO}	Local on/off voltage pin 1	-0.5	+80	Vdc
V _{RO}	Remote on/off voltage pin 2	-0.5	+80	Vdc
V _{RC}	Remote control voltage	0	6	V
V _{adj}	Output adjust voltage pin 17	-0.5	2×V _{OI}	Vdc

Stress in excess of Absolute Maximum Ratings may cause permanent damage. Absolute Maximum Ratings, sometimes referred to as no destruction limits, are normally tested with one parameter at a time exceeding the limits of Output data or Electrical Characteristics. If exposed to stress above these limits, function and performance may degrade in an unspecified manner.

Input T_C < T_C max

Characteristics		Conditions	min	typ	max	Unit
V _I	Input voltage range ¹⁾		36		75	V
V _{Ioff}	Turn-off input voltage	(See Operating Information)		32		V
V _{Ion}	Turn-on input voltage	(See Operating Information)		34		V
r _{Irush}	Equivalent inrush current resistance			150		mΩ
C _I	Input capacitance			4		μF
P _{Ii}	Input idling power	I _O =0, V _I = 53 V		1.3		W
P _{Ist-by}	Input stand-by power	V _I =53V, LO/RO to pin 6		0.25		W

Environmental Characteristics

Characteristics	Test procedure & conditions		
Vibration (Sinusoidal)	IEC 68-2-6 F _C	Frequency Amplitude Acceleration Number of cycles	10...500 Hz 0.75 mm 10 g 10 in each axis
Shock (Half sinus)	IEC 68-2-27 E _a	Peak acceleration Shock duration	200 g 3 ms
Temperature change	IEC 68-2-14 N _a	Temperature Number of cycles	-40°C... +125°C 300
Accelerated damp heat	IEC 68-2-3 C _a with bias	Temperature Humidity Duration	85°C 85% RH 1000 hours
Solder resistability	IEC 68-2-20 T _b 1A	Temperature, solder Duration	260°C 10...13 s
Resistance to cleaning solvents	IEC 68-2-45 XA Method 1	Water Isopropyl alcohol Terpens Method	+55 ±5°C +35 ±5°C +35 ±5°C with rubbing

Safety

The PKN 4000 I Series DC/DC power modules are designed in accordance with EN 60 950 *Safety of information technology equipment including electrical business equipment*, and certified by SEMKO.

The isolation is an operational insulation in accordance with EN 60 950.

The PKN DC/DC power modules are recognized by UL and meet the applicable requirements in UL 1950 *Safety of information technology equipment*, the applicable Canadian safety requirements and UL 1012 *Standard for power supplies*.

The DC/DC power module shall be installed in an end-use equipment and is intended to be supplied by isolated secondary circuitry and shall be installed in compliance with the requirements of the ultimate application. When the supply to the DC/DC power module meets all the requirements for SELV (<60Vdc), the output is considered to remain within SELV limits (level 3). If connected to a 60 V DC power system reinforced insulation must be provided in the power supply that isolates the input from the ac mains. Single fault testing in the power supply must be performed in combination with the DC/DC power module to demonstrate that the output meets the requirement for SELV. One pole of the input and one pole of the output is to be grounded or both are to be kept floating.

The terminal pins are only intended for connection to mating connectors of internal wiring inside the end-use equipment.

These DC/DC power modules may be used in telephone equipment in accordance with paragraph 34 A.1 of UL 1459 (Standard for Telephone Equipment, second edition).

The isolation voltage is a galvanic isolation and is verified in an electric strength test. Test voltage between input and output is 1500 V dc for 60 s. In production the test duration may be decreased to 1 s.

The capacitor between input and output has a value of 4.7 nF and the leakage current is less than 1μA @ 50 Vdc.

Flammability ratings of the terminal support and internal plastic construction details meets UL 94V-0.

Note:

- 1) The input voltage range 36...75 V meets the requirements in the European Telecom Standard prETS 300 132-2 for Normal input voltage range in 48 V and 60 V DC power systems, -40.5...-57.0 V and -50.0...-72.0 V respectively.

Mechanical Data

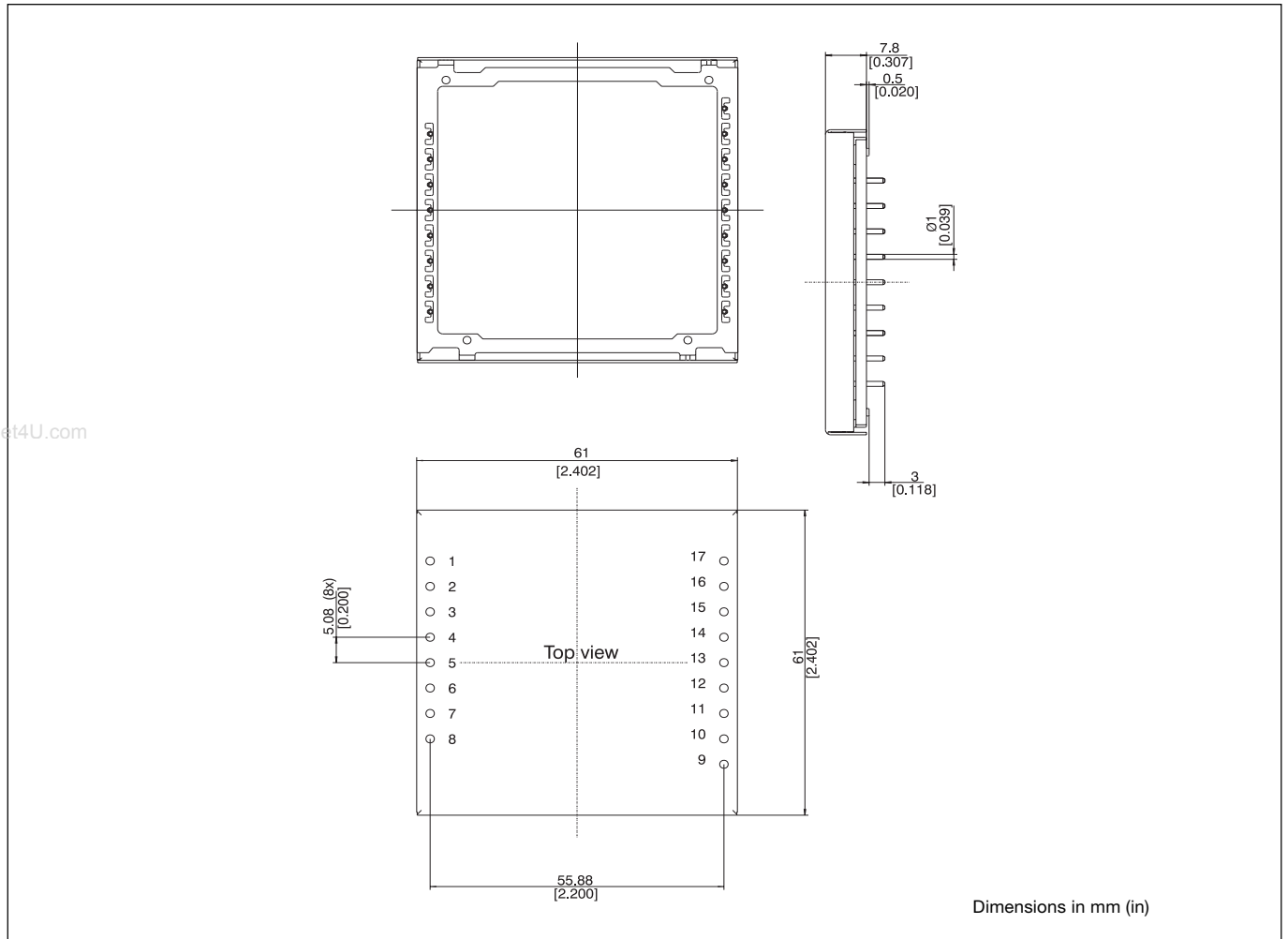

Connections Single output

Pin	Designation	Function
1	LO	Local on/off. Turns the module off immediately after LO pin is connected to positive input pin.
2	RO	Remote on/off. Turns the module off approx. 1.5 sec. after RO pin is connected to positive input pin.
3	R	Alarm reset. Resets the alarm and turns on the module when connected to the negative input pin.
4	P	Alarm. Alarm pin P goes high when active.
5	Q	Alarm battery pin. (Connected to positive input pin.)
6	-In	Negative input pin.
7	+In	Positive input pin. (Input ground.)
8	No pin	
9	- Out	Negative output pin.
10	- Out	Negative output pin.
11	- Out	Negative output pin.
12	No pin	
13	No pin	
14	+ Out	Positive output pin.
15	+ Out	Positive output pin.
16	+ Out	Positive output pin.
17	V _{adj}	Output voltage adjust.

Connections Dual output

Pin	Designation	Function
1	LO	Local on/off. Turns the module off immediately after LO pin is connected to positive input pin
2	RC	Remote Control. Turns the module off immediately after RC pin is connected to negative input pin
3	NC	Not Connected
4	NC	Not Connected
5	NC	Not Connected
6	- In	Negative input
7	+ In	Positive input
8	No pin	
9	V _{adj} Out 2	Output 2 voltage adjust
10	+Out 2	Output 2
11	+Out 2	Output 2
12	Rtn	Return
13	Rtn	Return
14	Rtn	Return
15	+ Out 1	Output 1
16	+ Out 1	Output 1
17	V _{adj} Out 1	Output 1 voltage adjust

Weight

Maximum 40 g (1.40 oz) for PKN single and maximum 45 g (1.58 oz) for PKN dual.

Case

Plastic coated aluminum casing with tin plated brass pins.

Electrical Data

Fundamental circuit diagram

Single output

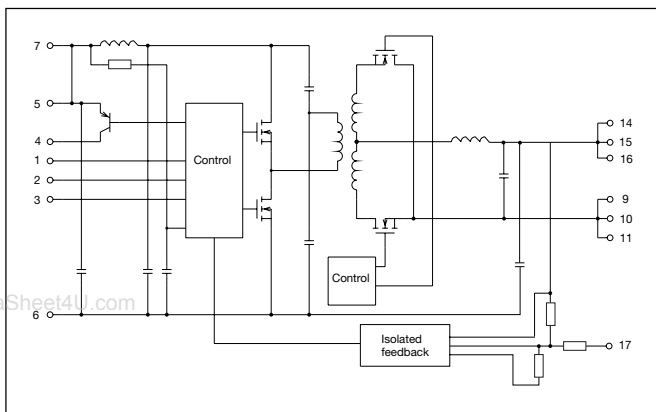

Dual output

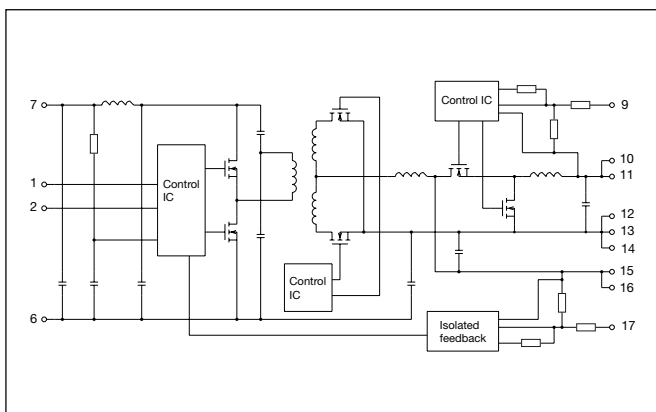

PKN 4318 PIOA

$T_C = -25...+90^\circ\text{C}$, $V_I = 36 \dots 75\text{V}$ unless otherwise specified.

Output

Characteristics		Conditions		Output 1			Unit
				min	typ	max	
V_{O_i}	Output voltage initial setting and accuracy	$T_C = +25^\circ\text{C}$, $I_O = 20\text{ A}$, $V_I = 53\text{ V}$		1.49	1.50	1.51	V
	Output adjust range ¹⁾			1.35		1.65	V
V_O	Output voltage tolerance band	Long term drift included	$I_O = 0.1 \dots 1.0 \times I_{O_{\text{max}}}$	1.47		1.53	V
	Idling voltage	$I_O = 0\text{ A}$		1.47		1.55	V
	Line regulation	$I_O = I_{O_{\text{max}}}$			1	20	mV
	Load regulation	$I_O = 0.01 \dots 1.0 \times I_{O_{\text{max}}}$, $V_I = 53\text{ V}$			15	30	mV
t_{tr}	Load transient recovery time	$I_O = 0.1 \dots 1.0 \times I_{O_{\text{max}}}$, $V_I = 53\text{ V}$ load step = $0.5 \times I_{O_{\text{max}}}$			100		μs
V_{tr}	Load transient voltage				+220		
			-220			mV	
t_r	Ramp-up time	$I_O = 0.1 \dots 1.0 \times I_{O_{\text{max}}}$ $V_I = 53\text{ V}$	$0.1 \dots 0.9 \times V_O$		10	25	ms
t_s	Start-up time		From V_I connection to $V_O = 0.9 \times V_{O_i}$		25	60	ms
I_O	Output current			0		20	A
$P_{O_{\text{max}}}$	Max output power ²⁾	Calculated value		30			W
I_{lim}	Current limiting threshold	$T_C < T_{C_{\text{max}}}$			22.5	24	A
I_{sc}	Short circuit current ³⁾	$T_C = +25^\circ\text{C}$				26	A
$V_{O_{\text{ac}}}$	Output ripple & noise	$I_O = I_{O_{\text{max}}}$	20 Hz...5 MHz		50	100	mV _{p-p}
SVR	Supply voltage rejection (ac)	$f = 100\text{ Hz}$ sine wave, 1 V_{p-p} , $V_I = 53\text{ V}$ ($\text{SVR} = 20 \log(1 \text{ V}_{p-p}/V_{O_{p-p}})$)		60			dB
OVP	Over voltage protection	$V_I = 53\text{ V}$		2.0	2.15	2.3	V
UVD	Under voltage detection	$V_I = 53\text{ V}$		0.4		1.0	V

¹⁾ See Operating information, Single output.

²⁾ See also Typical Characteristics, Power derating.

³⁾ The converter shuts down when the output voltage drops below the UVD level.

Miscellaneous

Characteristics		Conditions	min	typ	max	Unit
η	Efficiency	$I_O = I_{O_{\text{max}}}$, $V_I = 53\text{ V}$, $T_C = +25^\circ\text{C}$	86.5	87.3		%
P_d	Power dissipation	$I_O = I_{O_{\text{max}}}$, $V_I = 53\text{ V}$, $T_C = +25^\circ\text{C}$			4.7	W

PKN 4318 PI

$T_C = -25...+90^{\circ}\text{C}$, $V_I = 36 \dots 75\text{V}$ unless otherwise specified.

Output

Characteristics		Conditions		Output 1			Unit
				min	typ	max	
V_{O_i}	Output voltage initial setting and accuracy	$T_C = +25^{\circ}\text{C}$, $I_O = 20\text{ A}$, $V_I = 53\text{ V}$		1.79	1.80	1.81	V
	Output adjust range ¹⁾			1.60		2.00	V
V_O	Output voltage tolerance band	Long term drift included	$I_O = 0.1 \dots 1.0 \times I_{O_{\text{max}}}$	1.76		1.84	V
	Idling voltage	$I_O = 0\text{ A}$		1.76		1.90	V
	Line regulation	$I_O = I_{O_{\text{max}}}$			2	20	mV
	Load regulation	$I_O = 0.01 \dots 1.0 \times I_{O_{\text{max}}}$, $V_I = 53\text{ V}$			15	30	mV
t_{tr}	Load transient recovery time	$I_O = 0.1 \dots 1.0 \times I_{O_{\text{max}}}$, $V_I = 53\text{ V}$ load step = $0.5 \times I_{O_{\text{max}}}$			100		μs
V_{tr}	Load transient voltage				+250		
			-250			mV	
t_r	Ramp-up time	$I_O = 0.1 \dots 1.0 \times I_{O_{\text{max}}}$ $V_I = 53\text{ V}$	$0.1 \dots 0.9 \times V_O$		15	25	ms
t_s	Start-up time		From V_I connection to $V_O = 0.9 \times V_{O_i}$		25	60	ms
I_O	Output current			0		20	A
$P_{O_{\text{max}}}$	Max output power ²⁾	Calculated value		36			W
I_{lim}	Current limiting threshold	$T_C < T_{C_{\text{max}}}$			22.5	24	A
I_{sc}	Short circuit current ³⁾	$T_C = +25^{\circ}\text{C}$				26	A
$V_{O_{\text{ac}}}$	Output ripple & noise	$I_O = I_{O_{\text{max}}}$	20 Hz...5 MHz		50	100	mV _{p-p}
SVR	Supply voltage rejection (ac)	$f = 100\text{ Hz}$ sine wave, 1 V_{p-p} , $V_I = 53\text{ V}$ ($\text{SVR} = 20 \log(1\text{ V}_{p-p}/V_{O_{p-p}})$)		60			dB
OVP	Over voltage protection	$V_I = 53\text{ V}$		2.35	2.50	2.65	V
UVD	Under voltage detection	$V_I = 53\text{ V}$		0.4		1.2	V

¹⁾ See Operating information, Single output.

²⁾ See also Typical Characteristics, Power derating.

³⁾ The converter shuts down when the output voltage drops below the UVD level.

Miscellaneous

Characteristics		Conditions	min	typ	max	Unit
η	Efficiency	$I_O = I_{O_{\text{max}}}$, $V_I = 53\text{ V}$, $T_C = +25^{\circ}\text{C}$	87	88.5		%
P_d	Power dissipation	$I_O = I_{O_{\text{max}}}$, $V_I = 53\text{ V}$, $T_C = +25^{\circ}\text{C}$			5.4	W

PKN 4419 PI

$T_C = -25 \dots +90^\circ\text{C}$, $V_I = 36 \dots 75\text{V}$ unless otherwise specified.

Output

Characteristics		Conditions		Output 1			Unit
				min	typ	max	
V_{O_i}	Output voltage initial setting and accuracy	$T_C = +25^\circ\text{C}$, $I_O = 17\text{ A}$, $V_I = 53\text{ V}$		2.49	2.50	2.51	V
	Output adjust range ¹⁾			2.25		2.75	V
V_O	Output voltage tolerance band	Long term drift included	$I_O = 0.1 \dots 1.0 \times I_{O_{\text{max}}}$	2.45		2.55	V
	Idling voltage	$I_O = 0\text{ A}$		2.45		2.60	V
	Line regulation	$I_O = I_{O_{\text{max}}}$			2	15	mV
	Load regulation	$I_O = 0.01 \dots 1.0 \times I_{O_{\text{max}}}$, $V_I = 53\text{ V}$			13	25	mV
t_{tr}	Load transient recovery time	$I_O = 0.1 \dots 1.0 \times I_{O_{\text{max}}}$, $V_I = 53\text{ V}$ load step = $0.5 \times I_{O_{\text{max}}}$			100		μs
V_{tr}	Load transient voltage				+200		mV
			-200		mV		
t_r	Ramp-up time	$I_O = 0.1 \dots 1.0 \times I_{O_{\text{max}}}$ $V_I = 53\text{ V}$	$0.1 \dots 0.9 \times V_O$		15	25	ms
t_s	Start-up time		From V_I connection to $V_O = 0.9 \times V_{O_i}$		28	60	ms
I_O	Output current			0		17	A
$P_{O_{\text{max}}}$	Max output power ²⁾	Calculated value		42.5			W
I_{lim}	Current limiting threshold	$T_C < T_{C_{\text{max}}}$			19	20	A
I_{sc}	Short circuit current ³⁾	$T_C = +25^\circ\text{C}$				23	A
$V_{O_{ac}}$	Output ripple & noise	$I_O = I_{O_{\text{max}}}$	20 Hz ... 5 MHz		50	100	mV _{p-p}
SVR	Supply voltage rejection (ac)	$f = 100\text{ Hz}$ sine wave, 1 V_{p-p} , $V_I = 53\text{ V}$ ($\text{SVR} = 20 \log(1 \text{ V}_{p-p} / V_{O_{p-p}})$)		60			dB
OVP	Over voltage protection	$V_I = 53\text{ V}$		3.15	3.25	3.45	V
UVD	Under voltage detection	$V_I = 53\text{ V}$		1.25		1.85	V

¹⁾ See Operating information, Single output.

²⁾ See also Typical Characteristics, Power derating.

³⁾ The converter shuts down when the output voltage drops below the UVD level.

Miscellaneous

Characteristics		Conditions	min	typ	max	Unit
η	Efficiency	$I_O = I_{O_{\text{max}}}$, $V_I = 53\text{ V}$, $T_C = +25^\circ\text{C}$	88	89		%
P_d	Power dissipation	$I_O = I_{O_{\text{max}}}$, $V_I = 53\text{ V}$, $T_C = +25^\circ\text{C}$			5.8	W

PKN 4510 PI

$T_C = -25...+90^\circ\text{C}$, $V_I = 36 \dots 75\text{V}$ unless otherwise specified.

Output

Characteristics		Conditions		Output 1			Unit
				min	typ	max	
V_{oi}	Output voltage initial setting and accuracy	$T_C = +25^\circ\text{C}$, $I_O = 15\text{ A}$, $V_I = 53\text{ V}$		3.28	3.30	3.32	V
	Output adjust range ¹⁾			2.9		3.46	V
V_O	Output voltage tolerance band	Long term drift included	$I_O = 0.1 \dots 1.0 \times I_{Omax}$	3.18		3.40	V
	Idling voltage	$I_O = 0\text{ A}$		3.18		3.45	V
	Line regulation	$I_O = I_{Omax}$			2	15	mV
	Load regulation	$I_O = 0.01 \dots 1.0 \times I_{Omax}$, $V_I = 53\text{ V}$			10	25	mV
t_{tr}	Load transient recovery time	$I_O = 0.1 \dots 1.0 \times I_{Omax}$, $V_I = 53\text{ V}$ load step = $0.5 \times I_{Omax}$			100		μs
V_{tr}	Load transient voltage				+350		mV
			-350		mV		
t_r	Ramp-up time	$I_O = 0.1 \dots 1.0 \times I_{Omax}$ $V_I = 53\text{ V}$	$0.1 \dots 0.9 \times V_O$		15	25	ms
t_s	Start-up time		From V_I connection to $V_O = 0.9 \times V_{oi}$		28	60	ms
I_O	Output current			0		15	A
P_{Omax}	Max output power ²⁾	Calculated value		50			W
I_{lim}	Current limiting threshold	$T_C < T_{Cmax}$			17.5	18	A
I_{sc}	Short circuit current ³⁾	$T_C = +25^\circ\text{C}$				22	A
V_{Oac}	Output ripple & noise	$I_O = I_{Omax}$	20 Hz...5 MHz		50	100	mV _{p-p}
SVR	Supply voltage rejection (ac)	$f = 100\text{ Hz}$ sine wave, 1 V_{p-p} , $V_I = 53\text{ V}$ ($SVR = 20 \log(1\text{ V}_{p-p}/V_{O(p-p)})$)		60			dB
OVP	Over voltage protection	$V_I = 53\text{ V}$		3.80	3.90	4.05	V
UVD	Under voltage detection	$V_I = 53\text{ V}$		1.65		2.35	V

¹⁾ See Operating information, Single output.

²⁾ See also Typical Characteristics, Power derating.

³⁾ The converter shuts down when the output voltage drops below the UVD level.

Miscellaneous

Characteristics		Conditions	min	typ	max	Unit
η	Efficiency	$I_O = I_{Omax}$, $V_I = 53\text{ V}$, $T_C = +25^\circ\text{C}$	90	91		%
P_d	Power dissipation	$I_O = I_{Omax}$, $V_I = 53\text{ V}$, $T_C = +25^\circ\text{C}$			5.5	W

PKN 4511 PI

$T_C = -25...+90^\circ\text{C}$, $V_I = 36 \dots 75\text{V}$ unless otherwise specified.

Output

Characteristics		Conditions		Output 1			Unit
				min	typ	max	
V_{O1}	Output voltage initial setting and accuracy	$T_C = +25^\circ\text{C}$, $I_O = 10\text{ A}$, $V_I = 53\text{ V}$		5.10	5.15	5.20	V
	Output adjust range ¹⁾			4.65		5.65	V
V_O	Output voltage tolerance band	Long term drift included	$I_O = 0.1 \dots 1.0 \times I_{Omax}$	5.05		5.25	V
	Idling voltage	$I_O = 0\text{ A}$		5.00		5.40	V
	Line regulation	$I_O = I_{Omax}$			5	30	mV
	Load regulation	$I_O = 0.01 \dots 1.0 \times I_{Omax}$, $V_I = 53\text{ V}$			10	30	mV
t_{tr}	Load transient recovery time	$I_O = 0.1 \dots 1.0 \times I_{Omax}$, $V_I = 53\text{ V}$ load step = $0.5 \times I_{Omax}$			150		μs
V_{tr}	Load transient voltage				+500		
			-500			mV	
t_r	Ramp-up time	$I_O = 0.1 \dots 1.0 \times I_{Omax}$ $V_I = 53\text{ V}$	$0.1 \dots 0.9 \times V_O$		10	25	ms
t_s	Start-up time		From V_I connection to $V_O = 0.9 \times V_{O1}$		20	60	ms
I_O	Output current			0		10	A
P_{Omax}	Max output power ²⁾	Calculated value		51.5			W
I_{lim}	Current limiting threshold	$T_C < T_{Cmax}$			12.0	12.5	A
I_{sc}	Short circuit current ³⁾	$T_C = +25^\circ\text{C}$				15	A
V_{Oac}	Output ripple & noise	$I_O = I_{Omax}$	20 Hz...5 MHz		50	100	mV _{p-p}
SVR	Supply voltage rejection (ac)	$f = 100\text{ Hz}$ sine wave, 1 V_{p-p} , $V_I = 53\text{ V}$ ($SVR = 20 \log(1 \text{ V}_{p-p}/V_{O(p-p)})$)		60			dB
OVP	Over voltage protection	$V_I = 53\text{ V}$		6.3	6.5	6.7	V
UVD	Under voltage detection	$V_I = 53\text{ V}$		3.0		4.0	V

¹⁾ See Operating information, Single output.

²⁾ See also Typical Characteristics, Power derating.

³⁾ The converter shuts down when the output voltage drops below the UVD level.

Miscellaneous

Characteristics		Conditions	min	typ	max	Unit
η	Efficiency	$I_O = I_{Omax}$, $V_I = 53\text{ V}$, $T_C = +25^\circ\text{C}$	91	92		%
P_d	Power dissipation	$I_O = I_{Omax}$, $V_I = 53\text{ V}$, $T_C = +25^\circ\text{C}$			5.1	W

PKN 4520 API

$T_C = -25 \dots +90^\circ\text{C}$, $V_I = 36 \dots 75\text{V}$ unless otherwise specified. $I_{O1\text{ nom}} = 10\text{ A}$, $I_{O2\text{ nom}} = 6\text{ A}$.

Output

Characteristics		Conditions		Output 1			Output 2			Unit		
				min	typ	max	min	typ	max			
V_{O_i}	Output voltage initial setting and accuracy	$T_C = +25^\circ\text{C}$, $I_O = I_{O\text{ nom}}$, $V_I = 53\text{ V}$		3.28	3.30	3.32	2.48	2.50	2.52	V		
	Output adjust range ¹⁾			2.90		3.60		2.00		2.75		V
V_O	Output voltage tolerance band	Long term drift included	$I_O = 0.01 \dots 1.0 \times I_{O\text{ nom}}$		3.24	3.36		2.45	2.55		V	
	Idling voltage	$I_O = 0\text{ A}$		3.23	3.37		2.44	2.56		V		
	Line regulation	$I_O = I_{O\text{ nom}}$	$V_I = 36 \dots 75\text{ V}$		2		15		mV			
	Load regulation	$I_{O2} = I_{O2\text{ nom}}$, $V_I = 53\text{ V}$ $I_{O1} = 0.01 \dots 1.0 \times I_{O1\text{ nom}}$		10		25		10		25		mV
		$I_{O1} = I_{O1\text{ nom}}$, $V_I = 53\text{ V}$ $I_{O2} = 0.01 \dots 1.0 \times I_{O2\text{ nom}}$		10		25		10		25		mV
t_{tr}	Load transient recovery time	$I_O = 0.01 \dots 1.0 \times I_{O\text{ nom}}$, $V_I = 53\text{ V}$ load step = $0.5 \times I_{O\text{ nom}}$		100		50				μs		
V_{tr}	Load transient voltage			+330		+200				mV		
				-330		-200				mV		
t_r	Ramp-up time	$I_O = I_{O\text{ nom}}$	$V_O = 0.1 \dots 0.9 \times V_O$		15	45		5	25		ms	
t_s	Start-up time	$I_O = 0.1 \dots 1.0 \times I_{O\text{ nom}}$ $V_I = 53\text{ V}$	From V_I connection to $V_O = 0.9 \times V_{O_i}$		20	60		15	45		ms	
I_O	Output current			0	15		0	6		A		
$P_{O\text{ max}}$	Max output power ²⁾	Calculated value		min $50 - 0.333 \times I_{O2}$						W		
I_{lim}	Current limiting threshold ¹⁾	$T_C < T_{C\text{ max}}$		min $1.05 \times P_{O\text{ max}}$								
I_{sc}	Short circuit current	$T_C = +25^\circ\text{C}$, short circuit resistance max $20\text{ m}\Omega$		25		13				A		
V_{Oac}	Output ripple	$I_O = I_{O\text{ nom}}$	20 Hz ... 5 MHz		80	100		40	80		mV_{p-p}	
SVR	Supply voltage rejection (ac)	$f = 100\text{ Hz}$ sine wave, $1 V_{p-p}$, $V_I = 53\text{ V}$ ($\text{SVR} = 20 \log(1 V_{p-p}/V_{O p-p})$)		60		70				dB		
OVP	Over voltage protection	$V_I = 53\text{ V}$		3.9	4.1	4.4			V			
						4.0	7.5	16.0	%			

¹⁾ See Operating information, Dual output.

²⁾ See also Typical Characteristics, Power derating.

Miscellaneous

Characteristics		Conditions		min	typ	max	Unit
η	Efficiency	$I_O = I_{O\text{ nom}}$, $V_I = 53\text{ V}$		85	89		%
P_d	Power dissipation	$I_O = I_{O\text{ nom}}$, $V_I = 53\text{ V}$				8.5	W

PKN 4520 BPI

$T_C = -25 \dots +90^\circ\text{C}$, $V_I = 36 \dots 75\text{V}$ unless otherwise specified. $I_{O1\text{ nom}} = 10\text{A}$, $I_{O2\text{ nom}} = 8\text{A}$.

Output

Characteristics		Conditions		Output 1			Output 2			Unit	
				min	typ	max	min	typ	max		
V_{O1}	Output voltage initial setting and accuracy	$T_C = +25^\circ\text{C}$, $I_O = I_{O\text{ nom}}$, $V_I = 53\text{V}$		3.28	3.30	3.32	1.79	1.80	1.81	V	
	Output adjust range ¹⁾			2.90		3.60	1.60		2.00	V	
V_O	Output voltage tolerance band	Long term drift included	$I_O = 0.01 \dots 1.0 \times I_{O\text{ nom}}$	3.24		3.36	1.76		1.84	V	
	Idling voltage	$I_O = 0\text{A}$		3.23		3.37	1.75		1.85	V	
	Line regulation	$I_O = I_{O\text{ nom}}$	$V_I = 36 \dots 75\text{V}$	2		15	2		15	mV	
	Load regulation	$I_{O2} = I_{O2\text{ nom}}$, $V_I = 53\text{V}$ $I_{O1} = 0.01 \dots 1.0 \times I_{O1\text{ nom}}$		10		25	10		25	mV	
		$I_{O1} = I_{O1\text{ nom}}$, $V_I = 53\text{V}$ $I_{O2} = 0.01 \dots 1.0 \times I_{O2\text{ nom}}$		10		25	10		25	mV	
t_{tr}	Load transient recovery time	$I_O = 0.01 \dots 1.0 \times I_{O\text{ nom}}$, $V_I = 53\text{V}$ load step = $0.5 \times I_{O\text{ nom}}$		100			50			μs	
V_{tr}	Load transient voltage			+330			+200			mV	
					-330			-200			mV
t_r	Ramp-up time	$I_O = I_{O\text{ nom}}$	$V_O = 0.1 \dots 0.9 \times V_O$	15		45	5		20	ms	
t_s	Start-up time	$I_O = 0.1 \dots 1.0 \times I_{O\text{ nom}}$ $V_I = 53\text{V}$	From V_I connection to $V_O = 0.9 \times V_{O1}$	20		60	15		35	ms	
I_O	Output current			0		15	0		8	A	
$P_{O\text{ max}}$	Max output power ²⁾	Calculated value		min $50 - 0.325 \times I_{O2}$						W	
I_{lim}	Current limiting threshold ¹⁾	$T_C < T_{C\text{ max}}$		min $1.05 \times P_{O\text{ max}}$							
I_{sc}	Short circuit current	$T_C = +25^\circ\text{C}$, short circuit resistance max $20\text{ m}\Omega$		25			15			A	
V_{Oac}	Output ripple	$I_O = I_{O\text{ nom}}$	20 Hz ... 5 MHz	100		150	40		80	mV _{p-p}	
SVR	Supply voltage rejection (ac)	$f = 100\text{ Hz}$ sine wave, 1 V_{p-p} , $V_I = 53\text{V}$ ($\text{SVR} = 20 \log(1 \text{ V}_{p-p}/V_{O\text{ p-p}})$)		60			70			dB	
OVP	Over voltage protection	$V_I = 53\text{V}$		3.9	4.1	4.4				V	
							4.0	7.5	16.0	%	

¹⁾ See Operating information, Dual output.

²⁾ See also Typical Characteristics, Power derating.

Miscellaneous

Characteristics		Conditions		min	typ	max	Unit
η	Efficiency	$I_O = I_{O\text{ nom}}$, $V_I = 53\text{V}$		84	88		%
P_d	Power dissipation	$I_O = I_{O\text{ nom}}$, $V_I = 53\text{V}$		9.0			W

PKN 4520 BPIOA

$T_C = -25...+90^{\circ}\text{C}$, $V_I = 36...75\text{V}$ unless otherwise specified. $I_{O1\text{ nom}} = 10\text{ A}$, $I_{O2\text{ nom}} = 8\text{ A}$.

Output

Characteristics		Conditions		Output 1			Output 2			Unit	
				min	typ	max	min	typ	max		
V_{O_i}	Output voltage initial setting and accuracy	$T_C = +25^{\circ}\text{C}$, $I_O = I_{O\text{ nom}}$, $V_I = 53\text{ V}$		3.28	3.30	3.32	1.49	1.50	1.51	V	
	Output adjust range ¹⁾			2.90	3.60		1.35	1.65		V	
V_O	Output voltage tolerance band	Long term drift included	$I_O = 0.01...1.0 \times I_{O\text{ nom}}$		3.24	3.36		1.45	1.55		V
	Idling voltage	$I_O = 0\text{ A}$		3.23	3.37		1.46	1.54		V	
	Line regulation	$I_O = I_{O\text{ nom}}$	$V_I = 36...75\text{ V}$		2	15		2	15		mV
	Load regulation	$I_{O2} = I_{O2\text{ nom}}$, $V_I = 53\text{ V}$ $I_{O1} = 0.01...1.0 \times I_{O1\text{ nom}}$		10	25		10	25		mV	
		$I_{O1} = I_{O1\text{ nom}}$, $V_I = 53\text{ V}$ $I_{O2} = 0.01...1.0 \times I_{O2\text{ nom}}$		10	25		10	25		mV	
t_{tr}	Load transient recovery time	$I_O = 0.01...1.0 \times I_{O\text{ nom}}$, $V_I = 53\text{ V}$ load step = $0.5 \times I_{O\text{ nom}}$		120			80			μs	
V_{tr}	Load transient voltage			+300			+200			mV	
					-300			-200			mV
t_r	Ramp-up time	$I_O = I_{O\text{ nom}}$	$V_O = 0.1...0.9 \times V_O$		15	45		5	20		ms
t_s	Start-up time	$I_O = 0.1...1.0 \times I_{O\text{ nom}}$ $V_I = 53\text{ V}$	From V_I connection to $V_O = 0.9 \times V_{O_i}$		20	60		15	35		ms
I_O	Output current			0	15		0	8		A	
$P_{O\text{ max}}$	Max output power ²⁾	Calculated value		min $50 - 0.625 \times I_{O2}$						W	
I_{lim}	Current limiting threshold ¹⁾	$T_C < T_{C\text{ max}}$		min $1.05 \times P_{O\text{ max}}$							
I_{sc}	Short circuit current	$T_C = +25^{\circ}\text{C}$, short circuit resistance max $20\text{ m}\Omega$		25			15			A	
$V_{O\text{ ac}}$	Output ripple	$I_O = I_{O\text{ nom}}$	20 Hz... 5 MHz		100	150		40	80		mV_{p-p}
SVR	Supply voltage rejection (ac)	$f = 100\text{ Hz}$ sine wave, 1 V_{p-p} , $V_I = 53\text{ V}$ ($\text{SVR} = 20 \log(1\text{ V}_{p-p}/V_{O\text{ p-p}})$)		60			70			dB	
OVP	Over voltage protection	$V_I = 53\text{ V}$		3.9	4.1	4.4				V	
							4.0	7.5	16.0	%	

¹⁾ See Operating information, Dual output.

²⁾ See also Typical Characteristics, Power derating.

Miscellaneous

Characteristics		Conditions		min	typ	max	Unit
η	Efficiency	$I_O = I_{O\text{ nom}}$, $V_I = 53\text{ V}$		84	87		%
P_d	Power dissipation	$I_O = I_{O\text{ nom}}$, $V_I = 53\text{ V}$		8.6			W

PKN 4520 BPIOC

$T_C = -25...+90^{\circ}\text{C}$, $V_I = 36...75\text{V}$ unless otherwise specified. $I_{O1\text{ nom}} = 11\text{A}$, $I_{O2\text{ nom}} = 8\text{A}$.

Output

Characteristics		Conditions		Output 1			Output 2			Unit
				min	typ	max	min	typ	max	
V_{O1}	Output voltage initial setting and accuracy	$T_C = +25^{\circ}\text{C}$, $I_O = I_{O\text{ nom}}$, $V_I = 53\text{V}$		3.28	3.30	3.32	1.29	1.30	1.31	V
	Output adjust range ¹⁾			2.90		3.60	1.07		1.43	V
V_O	Output voltage tolerance band	Long term drift included	$I_O = 0.01...1.0 \times I_{O\text{ nom}}$	3.24		3.36	1.25		1.35	V
	Idling voltage	$I_O = 0\text{A}$		3.23		3.37	1.26		1.34	V
	Line regulation	$I_O = I_{O\text{ nom}}$	$V_I = 36...75\text{V}$		2	15		2	15	mV
	Load regulation	$I_{O2} = I_{O2\text{ nom}}$, $V_I = 53\text{V}$ $I_{O1} = 0.01...1.0 \times I_{O1\text{ nom}}$			10	25		10	25	mV
		$I_{O1} = I_{O1\text{ nom}}$, $V_I = 53\text{V}$ $I_{O2} = 0.01...1.0 \times I_{O2\text{ nom}}$			10	25		10	25	mV
t_{tr}	Load transient recovery time	$I_O = 0.01...1.0 \times I_{O\text{ nom}}$, $V_I = 53\text{V}$ load step = $0.5 \times I_{O\text{ nom}}$				120			80	μs
V_{tr}	Load transient voltage				+300		+200			
					-300			-200		mV
t_r	Ramp-up time	$I_O = I_{O\text{ nom}}$	$V_O = 0.1...0.9 \times V_O$		15	45		5	20	ms
t_s	Start-up time	$I_O = 0.1...1.0 \times I_{O\text{ nom}}$ $V_I = 53\text{V}$	From V_I connection to $V_O = 0.9 \times V_{O1}$		20	60		15	35	ms
I_O	Output current			0		15	0		8	A
$P_{O\text{ max}}$	Max output power ²⁾	Calculated value		min 50 - $0.412 \times I_{O2}$					W	
I_{lim}	Current limiting threshold ¹⁾	$T_C < T_{C\text{ max}}$		min $1.05 \times P_{O\text{ max}}$						
I_{sc}	Short circuit current	$T_C = +25^{\circ}\text{C}$, short circuit resistance max $20\text{ m}\Omega$				25			15	A
$V_{O\text{ ac}}$	Output ripple	$I_O = I_{O\text{ nom}}$	20 Hz... 5 MHz		100	150		40	80	$\text{mV}_{\text{p-p}}$
SVR	Supply voltage rejection (ac)	$f = 100\text{ Hz}$ sine wave, $1 V_{\text{p-p}}$, $V_I = 53\text{V}$ ($\text{SVR} = 20 \log(1 V_{\text{p-p}}/V_{O\text{ p-p}})$)		60			70			dB
OVP	Over voltage protection	$V_I = 53\text{V}$		3.9	4.1	4.4				V
							4.0	7.5	16.0	%

¹⁾ See Operating information, Dual output.

²⁾ See also Typical Characteristics, Power derating.

Miscellaneous

Characteristics		Conditions		min	typ	max	Unit
η	Efficiency	$I_O = I_{O\text{ nom}}$, $V_I = 53\text{V}$		84	87		%
P_d	Power dissipation	$I_O = I_{O\text{ nom}}$, $V_I = 53\text{V}$				8.6	W

Typical Characteristics

PKN 4318 PIOA

Efficiency (typ)

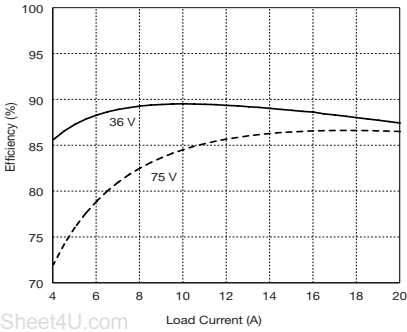

Output characteristic (typ)

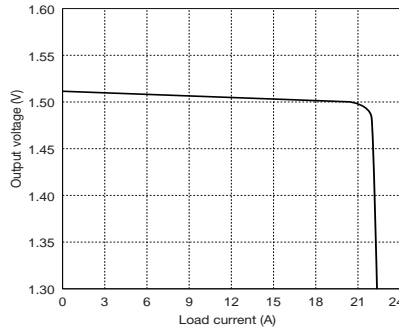

Power derating

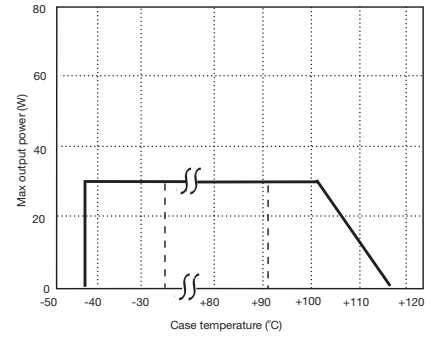

Dynamic load response (typ)

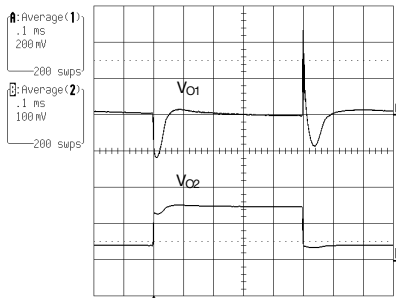

A. The output voltage deviation is determined by the load transient (di/dt)

B. Load change:
 $0.25 \times I_{O\text{nom}} \dots 0.75 \times I_{O\text{nom}} \dots 0.25 \times I_{O\text{nom}}$
 $di/dt \approx 5 \text{ A}/\mu\text{s}$

PKN 4318 PI

Efficiency (typ)

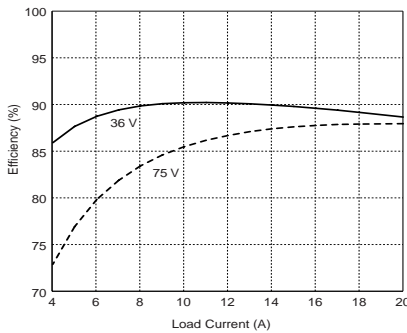

Output characteristic (typ)

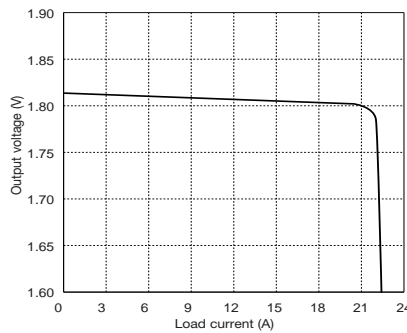

Power derating

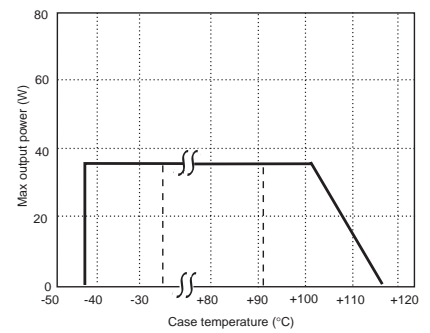

Dynamic load response (typ)

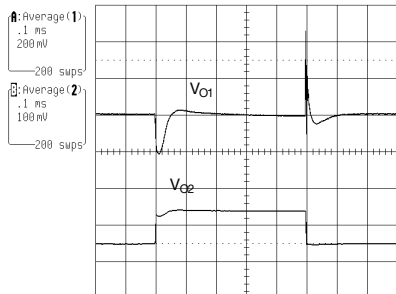

A. The output voltage deviation is determined by the load transient (di/dt)

B. Load change:
 $0.25 \times I_{O\text{nom}} \dots 0.75 \times I_{O\text{nom}} \dots 0.25 \times I_{O\text{nom}}$
 $di/dt \approx 5 \text{ A}/\mu\text{s}$

Typical Characteristics

PKN 4419 PI

Efficiency (typ)

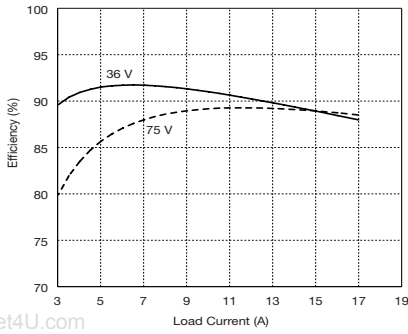

Output characteristic (typ)

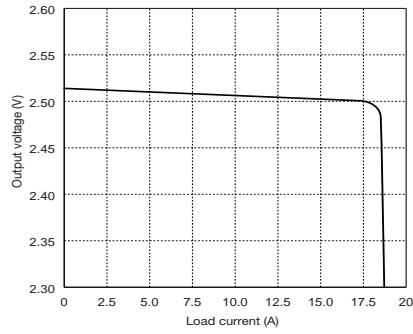

Power derating

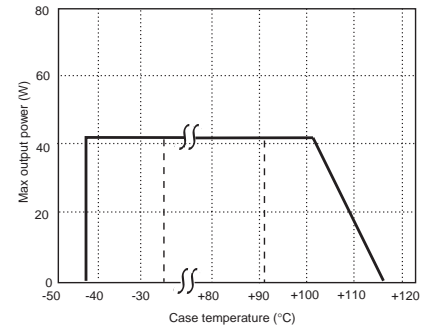

Dynamic load response (typ)

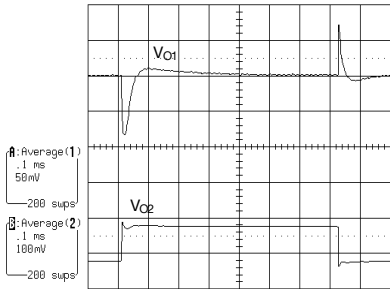

B. Load change:
 $0.25 \times I_{O\text{nom}} \dots 0.75 \times I_{O\text{nom}} \dots 0.25 \times I_{O\text{nom}}$
 $di/dt \approx 5 \text{ A}/\mu\text{s}$

A. The output voltage deviation is determined by the load transient (di/dt)

PKN 4510 PI

Efficiency (typ)

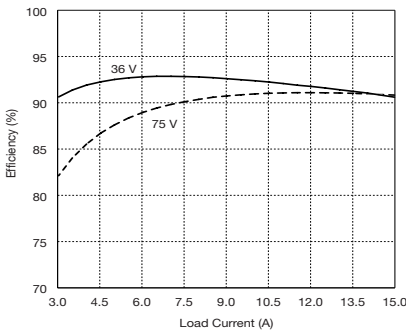

Output characteristic (typ)

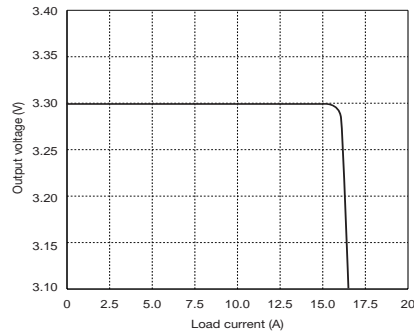

Power derating

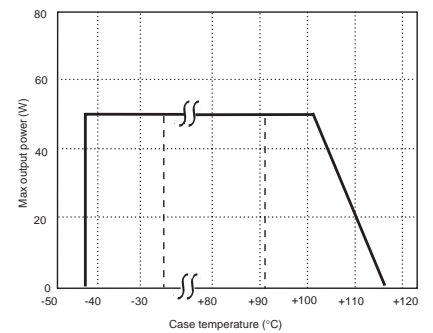

Dynamic load response (typ)

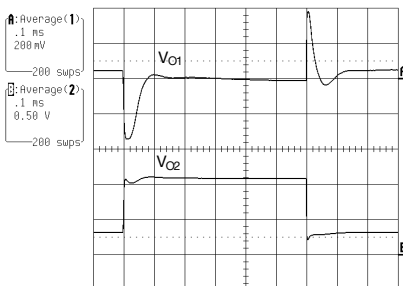

A. The output voltage deviation is determined by the load transient (di/dt)

B. Load change:
 $0.25 \times I_{O\text{nom}} \dots 0.75 \times I_{O\text{nom}} \dots 0.25 \times I_{O\text{nom}}$
 $di/dt \approx 5 \text{ A}/\mu\text{s}$

Typical Characteristics

PKN 4511 PI

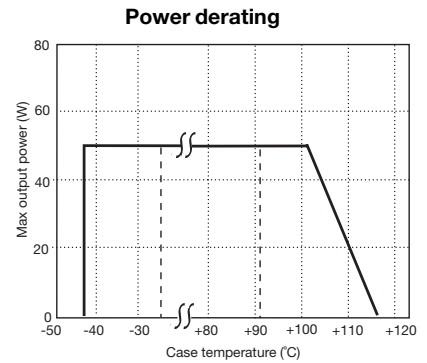
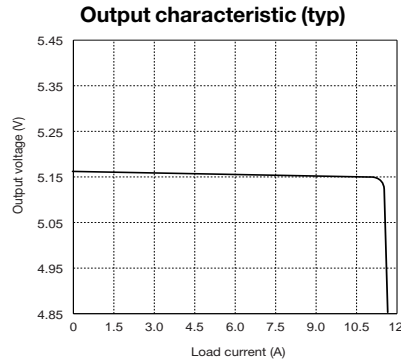
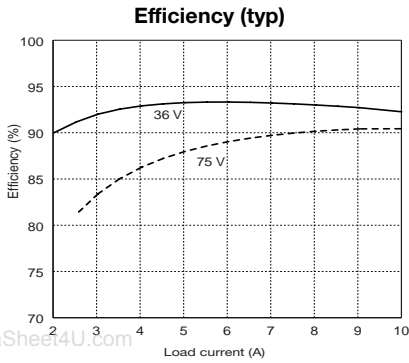

Dynamic load response (typ)

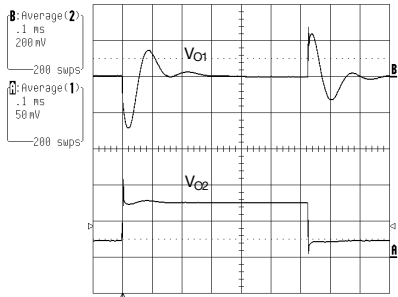

B. Load change:
 $0.25 \times I_{O\text{nom}} \dots 0.75 \times I_{O\text{nom}} \dots 0.25 \times I_{O\text{nom}}$
 $dI/dt \approx 5 \text{ A}/\mu\text{s}$

A. The output voltage deviation is determined by the load transient (dI/dt)

PKN 4520 API

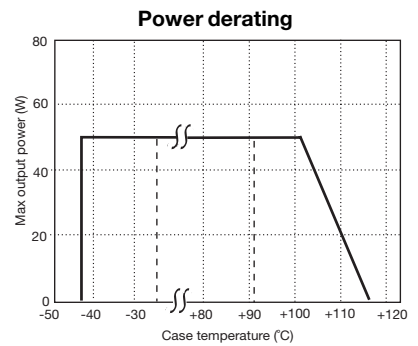
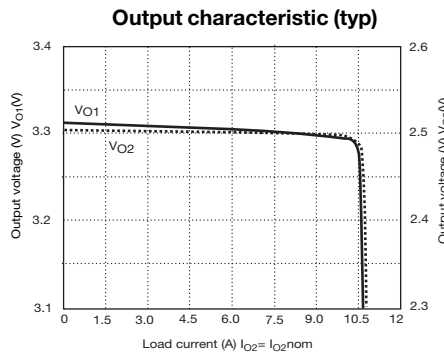
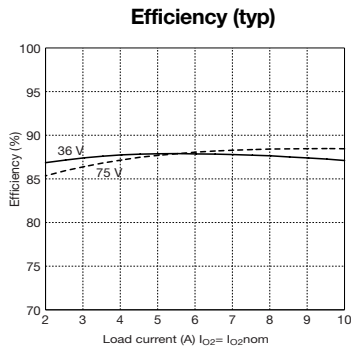

Dynamic load response (typ)

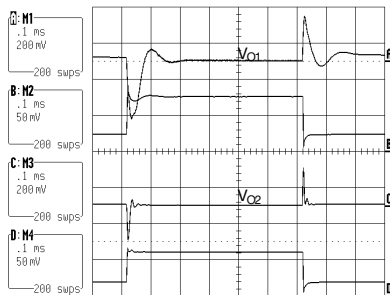

A, C. The output voltage deviation is determined by the load transient (dI/dt)

B, D. Load change:
 $0.25 \times I_{O\text{nom}} \dots 0.75 \times I_{O\text{nom}} \dots 0.25 \times I_{O\text{nom}}$
 $dI/dt \approx 5 \text{ A}/\mu\text{s}$

Start up (typ)

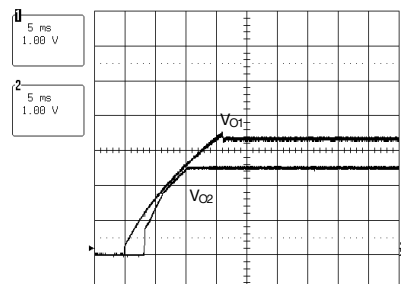

Typical Characteristics

PKN 4520 BPI

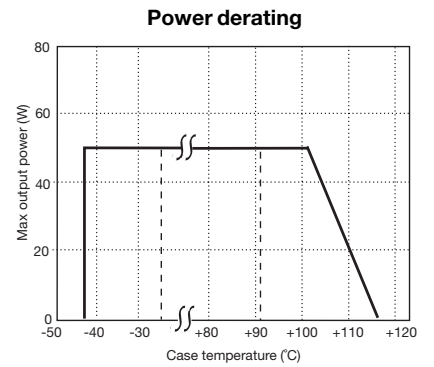
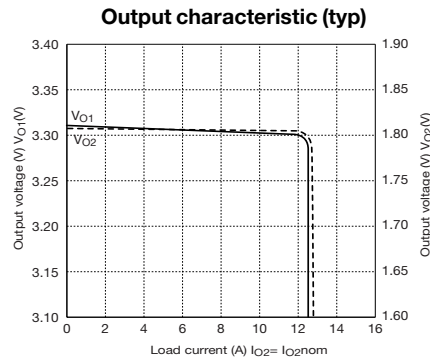
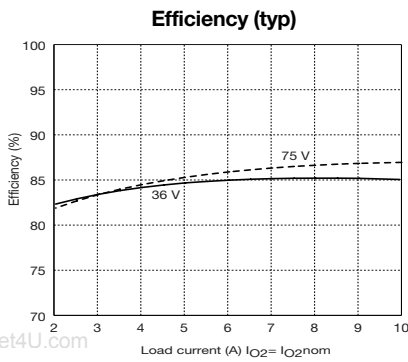

Dynamic load response (typ)

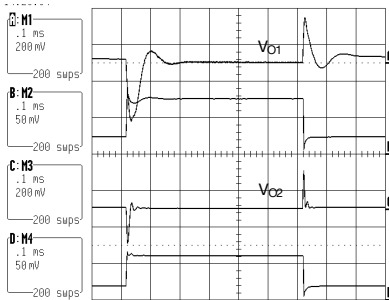

A, C. The output voltage deviation is determined by the load transient (di/dt)

B, D. Load change:
 $0.25 \times I_{O\text{nom}} \dots 0.75 \times I_{O\text{nom}} \dots 0.25 \times I_{O\text{nom}}$, $di/dt \approx 5 \text{ A}/\mu\text{s}$

Start up (typ)

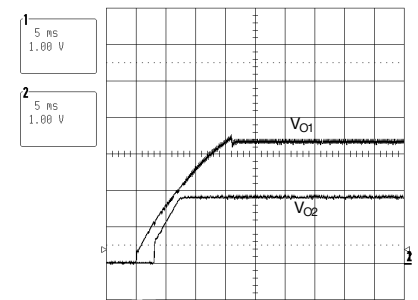

PKN 4520 BPIOA

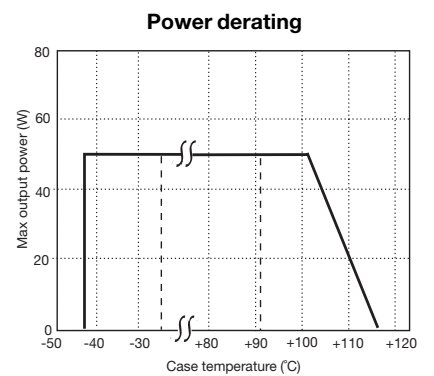
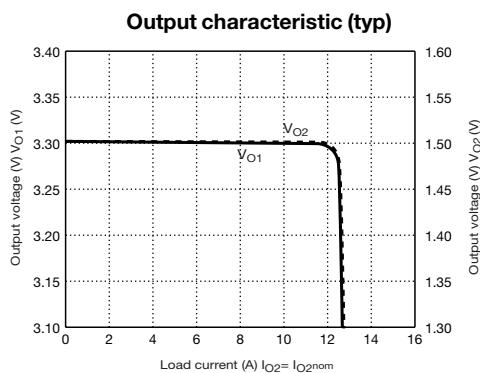
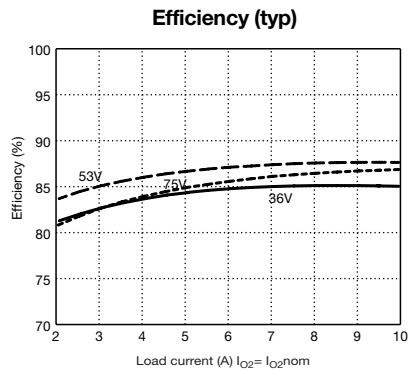

Dynamic load response (typ)

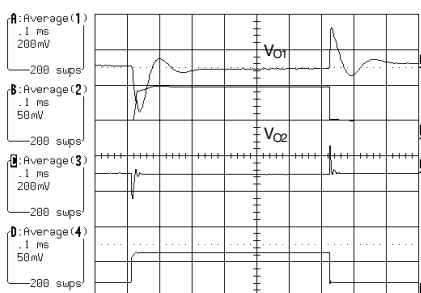

A, C. The output voltage deviation is determined by the load transient (di/dt)

B, D. Load change:
 $0.25 \times I_{O\text{nom}} \dots 0.75 \times I_{O\text{nom}} \dots 0.25 \times I_{O\text{nom}}$, $di/dt \approx 5 \text{ A}/\mu\text{s}$

Start up (typ)

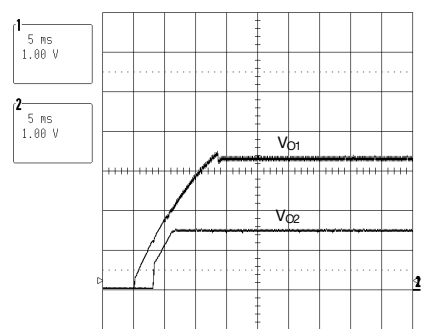

PKN 4520 BPIOC

Efficiency (typ)

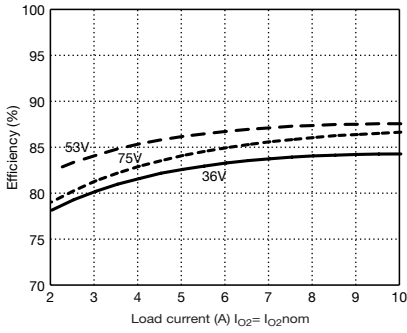

Output characteristic (typ)

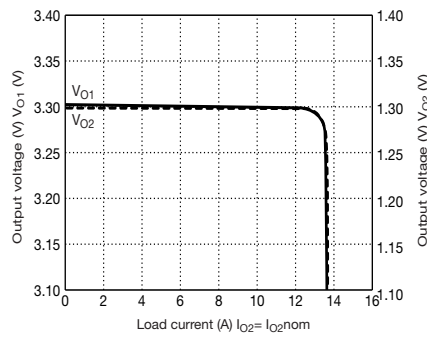

Power derating

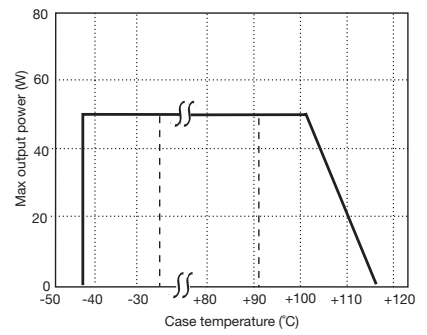

Dynamic load response (typ)

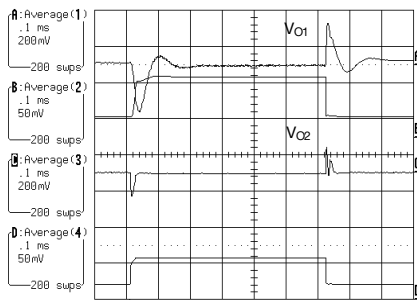

A, C. The output voltage deviation is determined by the load transient (di/dt)

B, D. Load change: $0.25 \times I_{Onom} \dots 0.75 \times I_{Onom} \dots 0.25 \times I_{Onom}$, $di/dt \approx 5 \text{ A}/\mu\text{s}$

Start up (typ)

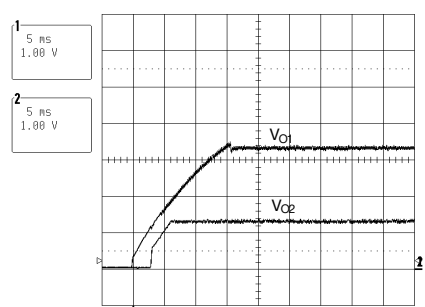

EMC Specifications

The conducted EMI measurement was performed using a module placed directly on the test bench.

The fundamental switching frequency for PKN single output is 160 kHz $\pm 5\%$ at $V_I = 53\text{ V}$, $I_O = (0.1 \dots 1.0) \times I_{O\text{ max}}$. For PKN dual it is 160 kHz $\pm 5\%$ on output 1 and 320 kHz $\pm 5\%$ on output 2.

Conducted EMI PKN 4510 PI Input terminal value (typ)

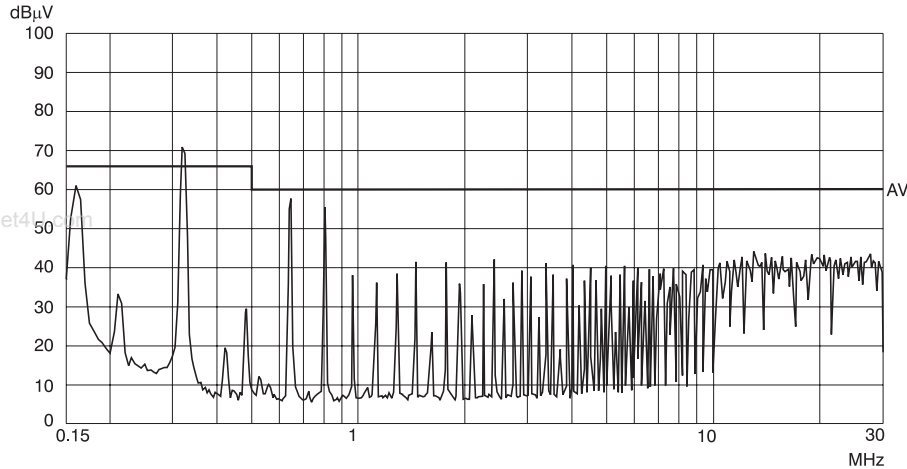

External Filter (class B)

Required external input filter in order to meet class B in EN 55022, CISPR 22 and FCC part 15J.

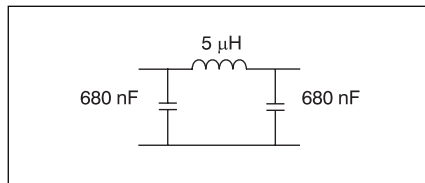

The capacitors are of ceramic type. The low ESR is critical for the result.

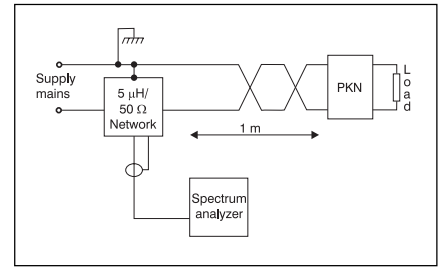
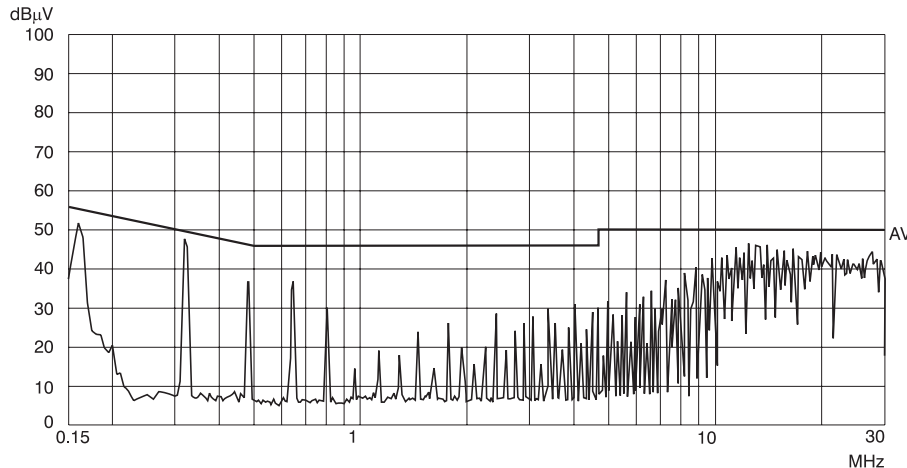

Test Set-up according to CISPR publ. 1A.

Radiated EMS (Electro-Magnetic Fields)

Radiated EMS is measured according to test methods in EN/IEC Standard 61000-4-3. No deviation outside the V_O tolerance band will occur under the following conditions:

Frequency range	Voltage level
0.08...1,000 MHz	3 V_{rms}/m

EFT

Electrical Fast Transients on the input terminals may cause output deviations outside what is tolerated by the electronic circuits, i.e. $\pm 5\%$.

The PKN power module can withstand EFT levels of 0.5 kV keeping V_O within the tolerance band and 2.0 kV without destruction. Tested according to EN/IEC Standard 61000-4-4.

Output Ripple & Noise (V_{Oac})

Output ripple is measured as the peak to peak voltage of the fundamental switching frequency.

Operating information, single output

To start the converter

The output UVD function is blocked for typically 100 ms after the input voltage is applied or the reset pin (R) is activated. If the output voltage of the converter does not reach over the UVD threshold within 100 ms, the converter will turn off. The rise time of the input voltage from 0V to 35V must not exceed 100 ms if the converter is to be started by turning on the primary voltage source.

Turn-off Input Voltage

The PKN power module monitors the input voltage and will turn on and turn off at predetermined levels. The minimum hysteresis between turn on and turn off input voltage is 1V where the turn on input voltage is the highest.

Load

The PKN series of converters has no limitation of maximum connected capacitance on the output. This is true as long as the output voltage reach over the UVD threshold within 100 ms after the input voltage is applied or the reset-pin is activated. Capacitance on the output will affect the ramp-up and the start-up time.

Parallel Operation

PKN can be paralleled for redundancy if external o-ring diodes are used in series with the outputs. It is not recommended to parallel PKN for increased power.

Thermal Data

The PKN DC/DC power module can deliver full power up to +80°C ambient at 1 m/s airflow.

Input and Output Impedance

Both the source impedance of the power feeding and the load impedance will interact with the impedance of the DC/DC power module.

It is most important to have the ratio between L and C as low as possible, i.e. a low characteristic impedance, both at the input and output, as the power modules have a low energy storage capability. Use an electrolytic capacitor across the input if the source or load inductance is larger than 10 μ H. Their equivalent series resistance together with the capacitance acts as a lossless damping filter. Suitable capacitor values are in the range 10–100 μ F.

Output Voltage Adjust (V_{adj})

To decrease the output voltage the resistor should be connected between pin 17 and pin 14–16 (+Out 1). To increase the output voltage the resistor should be connected between pin 17 and pin 9–11 (–Out 1). Output voltage, V_O , can be adjusted by using an external resistor.

Alarm and control functions

Reset pin (R)

When the reset pin (R) is connected to the negative input the converter will start after a delay of approximately 0.75 s and reset the alarm. The reset pin (R) shall normally be open and closed only when the converter shall start. To ensure safe turn-on the voltage difference between the negative input pin (–In) and the reset pin (R) shall be less than 1.0 V. R is TTL open collector compatible.

Remote On/Off (RO)

Turns off the converter when the remote off pin (RO) is connected to the positive input. The converter will stop after a delay of

approximately 1.5 second. To ensure safe turn-off the voltage difference between positive input pin (+In) and the remote off pin (RO) shall be less than 1.0 V. RO is TTL open collector compatible. The converter will restart when the RO pin is released.

Local On/Off (LO)

Turns off the converter when the local off pin (LO) is connected to the positive input. The converter will stop immediately. To ensure safe turn-off the voltage difference between positive input pin (+In) and the remote off pin (LO) shall be less than 1.0 V. LO is TTL open collector compatible. The converter will restart when the LO pin is released. Normal operation is achieved if the LO pin is open (NC) or connected to the –In pin. If the LO pin is not used it is recommended to connect it to –In.

Over Voltage Protection (OVP)

The Over Voltage Protection function will detect an over voltage on the output and immediately turn off the converter, at the same time the alarm pin (P) will go high. Using the reset pin (R) or toggle the input voltage off/on starts the converter again.

Under Voltage Detection (UVD)

The Under Voltage Detection function will detect an under voltage on the output and immediately turn off the converter, at the same time the alarm pin (P) will go high. Using the reset pin (R) or toggle the input voltage off/on starts the converter again.

Over Temperature Protection (OTP)

The PKN DC/DC power modules are protected from thermal overload by an internal over temperature shutdown circuit. When the case temperature exceeds +130 °C \pm 15 °C the converter will automatically shut down. Use the reset pin (R) or toggle the input voltage off/on to restart the converter.

Current Limit Protection

The output power is limited at loads above the current limit threshold (I_{lim}), specified as a minimum value. When the converter is in current limit function the output voltage will decrease until it reaches the UVD threshold, at the UVD threshold the converter will be turned off and the alarm pin (P) will go high.

Alarm pin (P)

The alarm pin (P) will go high when the module is off. The alarm output pin can drive a current of 70 mA.

Operating information, dual output

Turn-off Input Voltage

The PKN power module monitors the input voltage and will turn on and turn off at predetermined levels. The minimum hysteresis between turn on and turn off input voltage is 1V where the turn on input voltage is the highest.

Maximum Capacitive Load

The PKN series of converters has no limitation of maximum connected capacitance on the output. Capacitance on the output will affect the ramp-up and the start-up time.

Parallel Operation

PKN can be paralleled for redundancy if external o-ring diodes are used in series with the outputs. It is not recommended to parallel PKN for increased power.

Thermal Data

The PKN DC/DC power module can deliver full power up to +80°C ambient at 1 m/s airflow.

Input and Output Impedance

Both the source impedance of the power feeding and the load impedance will interact with the impedance of the DC/DC power module.

It is most important to have the ratio between L and C as low as possible, i.e. a low characteristic impedance, both at the input and output, as the power modules have a low energy storage capability. Use an electrolytic capacitor across the input if the source or load inductance is larger than 10 uH. Their equivalent series resistance together with the capacitance acts as a lossless damping filter. Suitable capacitor values are in the range 10–100 µF.

Output Voltage Adjust (V_{adj})

The two outputs can be independently adjusted.

To decrease the voltage on output 1 the resistor should be connected between pin 17 and pin 15–16 (+Out 1). To increase the voltage on output 1 the resistor should be connected between pin 17 and pin 12–14 (Rtn). A 0.1 MΩ resistor will change V_{out1} approximately 7%. To decrease the voltage on output 2 the resistor should be connected between pin 9 and pin 10–11 (+Out 2). To increase the voltage on output 2 the resistor should be connected between pin 9 and pin 12–14 (Rtn). A 0.1 MΩ resistor will change V_{out2} approximately 5%.

Alarm and control functions

Remote Control (RC)

Turns off the converter when the remote control pin (RC) is connected to the negative input. The converter will stop immediately. To ensure safe turn-off the voltage difference between negative input pin (–In) and the RC pin shall be less than 0.6 V. The converter will restart when the RC pin is released. Normal is achieved if the RC pin is open (NC).

Local On/Off (LO)

Turns off the converter when the local off pin (LO) is connected to the positive input. The converter will stop immediately. To ensure safe turn-off the voltage difference between positive input pin (+In) and the remote off pin (LO) shall be less than 1.0 V. LO is TTL open collector compatible. The converter will restart when the LO pin is released. Normal operation is achieved if the LO pin is open (NC) or connected to the –In pin. If the LO pin is not used it is recommended to connect it to –In.

Over Voltage Protection (OVP)

Output 1: The over voltage protection function will detect an over voltage on the output and immediately turn off the converter (both output 1 and 2). The OVP is input voltage dependent and has its highest level at approximately $V_1 = 47.5$ V, below that input voltage the output voltage is limited by the maximum duty cycle of the converter. Using the local on/off pin (LO) starts the converter again. The remote control pin (RC) can also be used but the voltage difference between –In pin and the RC pin shall be less than 0.08 V.

Output 2: The over voltage protection function will detect an over voltage on the output and limit the power conversion to output 2.

Over Temperature Protection (OTP)

The PKN DC/DC power modules are protected from thermal over load by an internal over temperature shutdown circuit. When the case temperature exceeds +130°C ±15°C the converter will automatically shut down. If the temperature returns to a normal level normal operation automatically resumes.

Current Limit Protection

Output 1: The total output power is limited by the current limit on output 1.

Output 2: Foldback current limiting when the current exceeds the output 2 current limiting threshold.

Quality

Reliability

Meantime between failure (MTBF) is calculated to >1.7 million hours at full output power and a case temperature of +75°C ($T_A = +40^\circ\text{C}$), using the Ericsson failure rate data system. The Ericsson failure rate data system is based on field failure rates and is continuously updated. The data corresponds to actual failure rates of component used in Information Technology and Telecom equipment in temperature controlled environments ($T_A = -5 \dots +65^\circ\text{C}$). The data is considered to have a confidence level of 90%. For more information see Design Note 002.

Quality Statement

The products are designed and manufactured in an industrial environment where quality systems and methods like ISO 9000, 6s and SPC, are intensively in use to boost the continuous improvements strategy. Infant mortality or early failures in the products are screened out by a burn-in procedure and an ATE-based final test.

Conservative design rules, design reviews and product qualifications, as well as high competence of an engaged work force, contribute to the high quality of our products.

Warranty

Ericsson Microelectronics warrants to the original purchaser or end user that the products conform to this Data Sheet and are free from material and workmanship defects for a period of five (5) years from the date of manufacture, if the product is used within specified conditions and not opened. In case the product is discontinued, claims will be accepted up to three (3) years from the date of the discontinuation.

For additional details on this limited warranty we refer to Ericsson Microelectronics AB's "General Terms and Conditions of Sales", or individual contract documents.

Limitation of Liability

Ericsson Microelectronics does not make any other warranties, expressed or implied including any warranty of merchantability or fitness for a particular purpose (including, but not limited to, use in life support applications, where malfunctions of product can cause injury to a person's health or life).

Information given in this data sheet is believed to be accurate and reliable. No responsibility is assumed for the consequences of its use nor for any infringement of patents or other rights of third parties which may result from its use. No license is granted by implication or otherwise under any patent or patent rights of Ericsson Microelectronics. These products are sold only according to Ericsson Microelectronics' general conditions of sale, unless otherwise confirmed in writing. Specifications subject to change without notice.

Product Program

V _I	V _O /I _O max		P _O max	Ordering No.
	Output 1	Output 2		
48/60 V	1.5V/20A		30 W	PKN 4318 PIOA
	1.8V/20A		36 W	PKN 4318 PI
	2.5V/17A		42 W	PKN 4419 PI
	3.3V/15A		50 W	PKN 4510 PI
	5V/10A		50 W	PKN 4511 PI
	3.3V/15A	2.5V/6A	50 W	PKN 4520 API
	3.3V/15A	1.8V/8A	50 W	PKN 4520 BPI
	3.3V/15A	1.5V/8A	50 W	PKN 4520 BPIOA
	3.3V/15A	1.3V/8A	50 W	PKN 4520 BPIOC

www.DataSheet4U.com

Ericsson Microelectronics
 SE-164 81 KISTA, Sweden
 Phone: +46 8 757 5000
www.ericsson.com/microelectronics

For local sales contacts, please refer to our website
 or call: Int. +46 8 757 4700, Fax: +46 8 757 4776

The latest and most complete information can be found on our website

Preliminary Data Sheet

EN/LZT 146 27 R4A
 © Ericsson Microelectronics AB, February 2002

www.DataSheet4U.com