

**Simple Switcher  
3A Step- Down Voltage Regulator**

# PL2576-XXXXF5

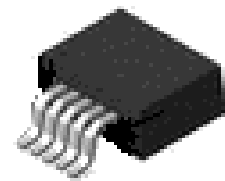

TO-263-5L

**Features**

- 3.3V, 5V, 12V, 15V, and adjustable output versions.
- Adjustable version output voltage range, 1.23V to 37V $\pm$ 4% max over line and load conditions.
- Guaranteed 3A output current.
- Wide input voltage range.
- Requires only 4 external components
- 52 kHz fixed frequency oscillator
- TTL shutdown capability, low power standby mode.
- High efficiency
- Uses readily available standard inductors.
- Thermal shutdown and current limit protection.

**Description**

The PL2576-XXXXF5 series of regulators are monolithic integrated circuits that provide all the active functions for a step-down (buck) switching regulator, capable of driving 3A load with excellent line and load regulation. These devices are available in fixed output voltages of 3.3V, 5V, 12V, 15V, and an adjustable output version. Requiring a minimum number of external components, these regulators are simple to use and include internal frequency compensation and a fixed-frequency oscillator.

The PL2576-XXXXF5 series offers a high-efficiency replacement for popular three-terminal linear regulators. It substantially reduces the size of the heat sink, and in some cases no heat sink is required.

A standard series of inductors optimized for use with the PL2576 are available from several different manufacturers. This feature greatly simplifies the design of switch-mode power supplies.

Other features include a guaranteed  $\pm$ 4% tolerance on output voltage within specified input voltages and output load conditions, and  $\pm$ 10% on the oscillator frequency. External shutdown is included, featuring 50 $\mu$ A (typical) standby current. The output switch includes cycle-by-cycle current limiting, as well as thermal shutdown for full protection under fault conditions.

**Applications**

- Simple high-efficiency step-down (buck) regulator.
- Efficient pre-regulator for linear regulators.
- On-card switching regulators.
- Positive to negative converter (Buck-Boost).

## Typical Application (Fixed Output Voltage Version)

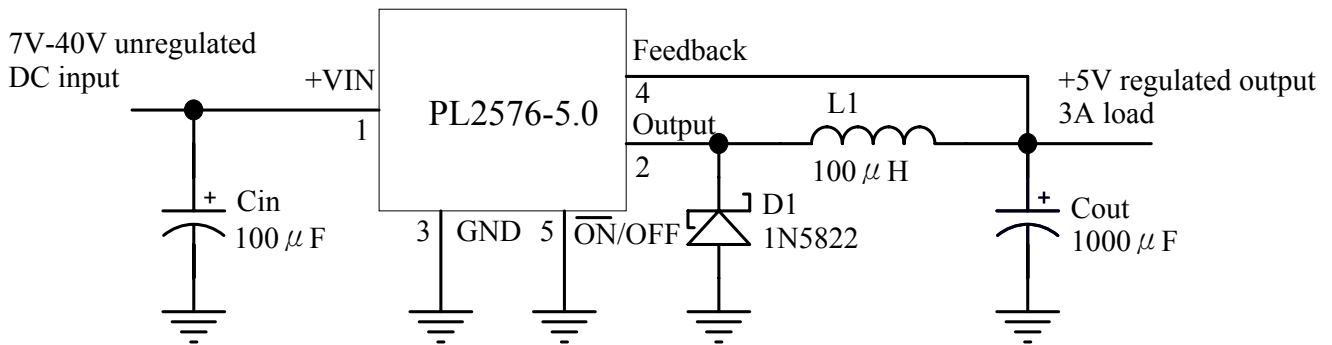

**Figure. 1**

## Block Diagram

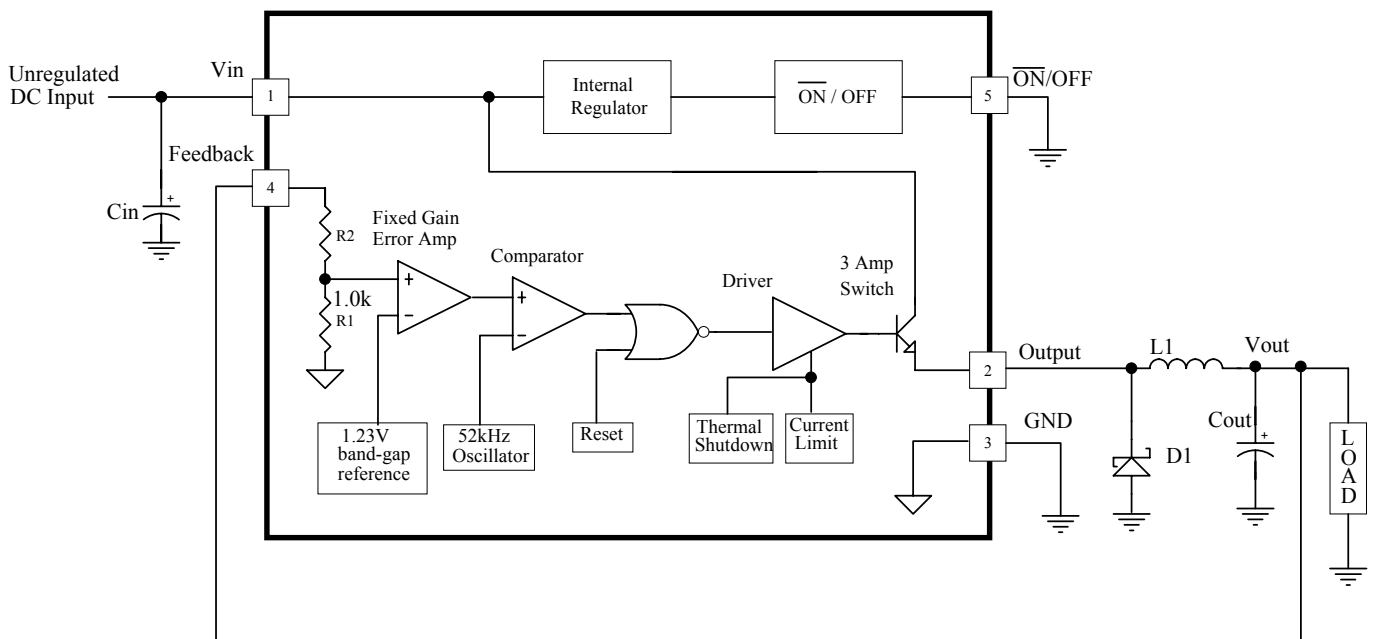

3.3V, R2=1.7k  
 5V, R2=3.1k  
 12V, R2=8.84k  
 15V, R2=11.3k  
 For Adjustable version, R1=open, R2=0

## Ordering Information

Temperature Range	Output Voltage					Package Type
	3.3	5.0	12	15	ADJ	
-40°C ≤ TA ≤ 125°C	PL2576-3.3F5	PL2576-5.0F5	PL2576-12F5	PL2576-15F5	PL2576-ADJF5	TO-263-5L



## Absolute Maximum Ratings (Note 1)

Maximum supply voltage .....	45V
ON/OFF pin input voltage .....	$-0.3V \leq V \leq +V_{IN}$
Output voltage to ground (steady state).....	-1V
Power dissipation .....	Internally limited
Storage temperature range.....	-65°C to +150°C
Maximum junction temperature.....	150°C
Minimum ESD rating (C=100pF, R=1.5kΩ).....	2kV
Lead temperature (Soldering, 10 seconds).....	260°C

## Operating Ratings

Temperature range.....	$-40^{\circ}\text{C} \leq T_J \leq +125^{\circ}\text{C}$
Supply voltage.....	40V

## PL2576-3.3 Electrical Characteristics

Specifications with standard type face are for  $T_J=25^{\circ}\text{C}$ , and those with **boldface type** apply over full operating temperature range

Symbol	Parameter	Conditions	Typ	Min	Max	Units
<b>System Parameters (Note 3) Test Circuit Figure 2</b>						
$V_{OUT}$	Output Voltage	$V_{IN}=12V, I_{LOAD}=0.5A$ Circuit of Figure 2	3.3	3.234	3.336	V
$V_{OUT}$	Output Voltage	$6V \leq V_{IN} \leq 40V, 0.5A \leq I_{LOAD} \leq 3A$ Circuit of Figure 2	3.3	3.168/ <b>3.135</b>	3.432/ <b>3.465</b>	V
$\eta$	Efficiency	$V_{IN}=12V, I_{LOAD}=3A$	75			%

## PL2576-5.0 Electrical Characteristics

Specifications with standard type face are for  $T_J=25^{\circ}\text{C}$ , and those with **boldface type** apply over full operating temperature range

Symbol	Parameter	Conditions	Typ	Min	Max	Units
<b>System Parameters (Note 3) Test Circuit Figure 2</b>						
$V_{OUT}$	Output Voltage	$V_{IN}=12V, I_{LOAD}=0.5A$ Circuit of Figure 2	5.0	4.9	5.1	V
$V_{OUT}$	Output Voltage	$8V \leq V_{IN} \leq 40V, 0.5A \leq I_{LOAD} \leq 3A$ Circuit of Figure 2	3.3	4.800/ <b>4.750</b>	5.200/ <b>5.250</b>	V
$\eta$	Efficiency	$V_{IN}=12V, I_{LOAD}=3A$	77			%



## PL2576-12 Electrical Characteristics

Specifications with standard type face are for  $T_J=25^{\circ}\text{C}$ , and those with **boldface type** apply over full operating temperature range

Symbol	Parameter	Conditions	Typ	Min	Max	Units
<b>System Parameters (Note 3) Test Circuit Figure 2</b>						
$V_{OUT}$	Output Voltage	$V_{IN}=25\text{V}$ , $I_{LOAD}=0.5\text{A}$ Circuit of Figure 2	12	11.76	12.24	V
$V_{OUT}$	Output Voltage	$15\text{V} \leq V_{IN} \leq 40\text{V}$ , $0.5\text{A} \leq I_{LOAD} \leq 3\text{A}$ Circuit of Figure 2	12	11.52/ <b>11.40</b>	12.48/ <b>12.60</b>	V
$\eta$	Efficiency	$V_{IN}=15\text{V}$ , $I_{LOAD}=3\text{A}$	88			%

## PL2576-15 Electrical Characteristics

Specifications with standard type face are for  $T_J=25^{\circ}\text{C}$ , and those with **boldface type** apply over full operating temperature range

Symbol	Parameter	Conditions	Typ	Min	Max	Units
<b>System Parameters (Note 3) Test Circuit Figure 2</b>						
$V_{OUT}$	Output Voltage	$V_{IN}=25\text{V}$ , $I_{LOAD}=0.5\text{A}$ Circuit of Figure 2	15	14.7	15.3	V
$V_{OUT}$	Output Voltage	$18\text{V} \leq V_{IN} \leq 40\text{V}$ , $0.5\text{A} \leq I_{LOAD} \leq 3\text{A}$ Circuit of Figure 2	3.3	14.40/ <b>14.25</b>	15.60/ <b>15.75</b>	V
$\eta$	Efficiency	$V_{IN}=18\text{V}$ , $I_{LOAD}=3\text{A}$	88			%

## PL2576-ADJ Electrical Characteristics

Specifications with standard type face are for  $T_J=25^{\circ}\text{C}$ , and those with **boldface type** apply over full operating temperature range

Symbol	Parameter	Conditions	Typ	Min	Max	Units
<b>System Parameters (Note 3) Test Circuit Figure 2</b>						
$V_{OUT}$	Feedback Voltage	$V_{IN}=12\text{V}$ , $I_{LOAD}=0.5\text{A}$ , $V_{OUT}=5\text{V}$ , Circuit of Figure 2	1.230	1.217	1.243	V
$V_{OUT}$	Feedback Voltage	$8\text{V} \leq V_{IN} \leq 40\text{V}$ , $0.5\text{A} \leq I_{LOAD} \leq 3\text{A}$ $V_{OUT}=5\text{V}$ , Circuit of Figure 2	1.230	1.193/ <b>1.180</b>	1.267/ <b>1.280</b>	V
$\eta$	Efficiency	$V_{IN}=12\text{V}$ , $I_{LOAD}=3\text{A}$ , $V_{OUT}=5\text{V}$	77			%



## All Output Voltage Versions Electrical Characteristics

Specifications with standard type face are for  $T_J=25^{\circ}\text{C}$ , and those with **boldface type** apply over full operating temperature range. Unless otherwise specified,  $V_{IN}=12\text{V}$  for the 3.3V, 5.0V, and adjustable versions,  $V_{IN}=25\text{V}$  for the 12V version, and  $V_{IN}=30\text{V}$  for the 15V version.  $I_{LOAD}=500\text{mA}$ .

Symbol	Parameter	Conditions	Typ	Min	Max	Units
I <sub>b</sub>	Feedback bias current	V <sub>OUT</sub> =5V (adjustable version only)	50	-	100/ <b>500</b>	nA
f <sub>o</sub>	Oscillator frequency	(Note 8)	52	47/ <b>42</b>	58/ <b>63</b>	kHz
V <sub>SAT</sub>	Saturation voltage	I <sub>OUT</sub> =3A (Note 4)	1.4	-	1.8/ <b>2.0</b>	V
DC	Maximum duty cycle (ON)	(Note 5)	98	93	-	%
I <sub>CL</sub>	Current limit	(Notes 4, 8)	5.8	4.2/ <b>3.5</b>	6.9/ <b>7.5</b>	A
I <sub>L</sub>	Output leakage current	(Notes 6, 7) Output = 0V Output = -1V	- 7.5	- -	2 30	mA
I <sub>Q</sub>	Quiescent current	(Note 6)	5	-	10	mA
I <sub>STBY</sub>	Standby quiescent current	— ON/OFF pin=5V (OFF)	50	-	200	μA
<b>ON/OFF Control</b>						
V <sub>IH</sub>	—	V <sub>OUT</sub> =0V	1.4	2.2/ <b>2.4</b>	-	V
V <sub>IL</sub>	ON/OFF pin logic input level	V <sub>OUT</sub> =Nominal output voltage	1.2	-	1.0/ <b>0.8</b>	V
I <sub>IH</sub>	—	—	12	-	30	μA
I <sub>IL</sub>	ON/OFF pin input current	ON/OFF pin=5V (OFF) — ON/OFF pin=0V (ON)	— 0	- -	30 10	μA

**Note 1 :** Absolute Maximum Ratings indicate limits beyond which damage to the device may occur. Operating Ratings indicate conditions for which the device is intended to be functional, but do not guarantee specific performance limits. For guaranteed specifications and test conditions, see the Electrical Characteristics.

**Note 2 :** All limits guaranteed at room temperature (standard type face) and at temperature extremes (bold type face).

**Note 3 :** External components such as the catch diode, inductor, input and output capacitors can affect switching regulator system performance. When the PL2576 is used as shown in the figure 2 test circuit, system performance will be as shown in system parameters section of Electrical Characteristics.

**Note 4 :** Output pin sourcing current. No diode, inductor or capacitor connected to output.

**Note 5 :** Feedback pin removed from output and connected to 0V.

**Note 6 :** Feedback pin removed from output and connected to +12V for the Adjustable, 3.3V, and 5V versions, and +25V for the 12V and 15V versions, to force the output transistor OFF.

**Note 7 :** V<sub>IN</sub>=40V.

**Note 8 :** The oscillator frequency reduces to approximately 11 kHz in the event of an output short or an overload which causes the regulated output voltage to drop approximately 40% from the nominal output voltage. This self protection feature lowers the average power dissipation of the IC by lowering the minimum duty cycle from 5% down to approximately 2%.

## Typical Performance Characteristics (circuit of Figure 2)

### Normalized Output Voltage

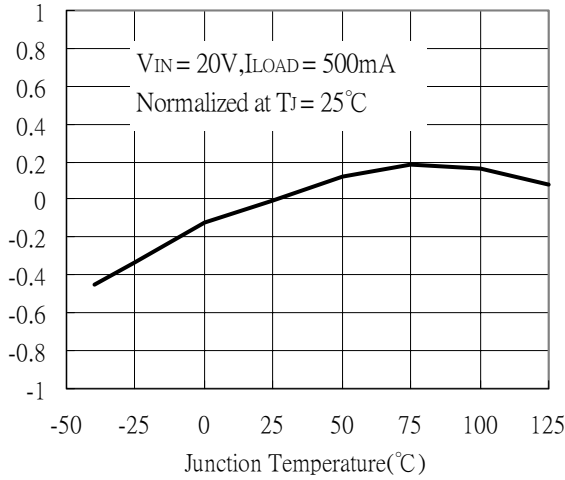

### Line Regulation

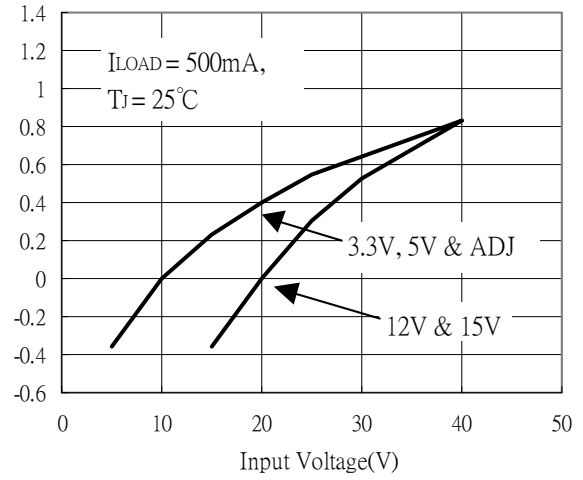

### Dropout Voltage

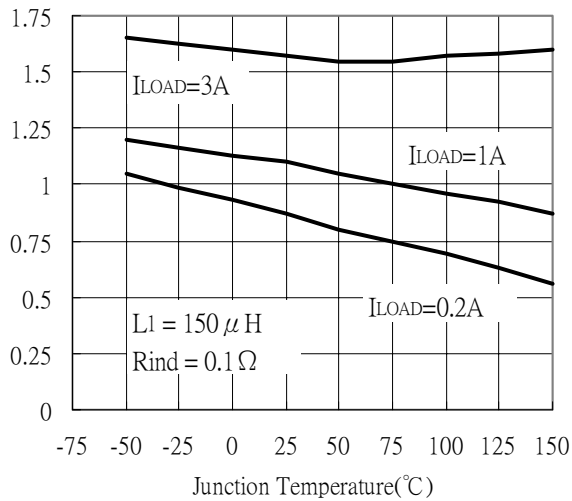

### Standby Quiescent Current

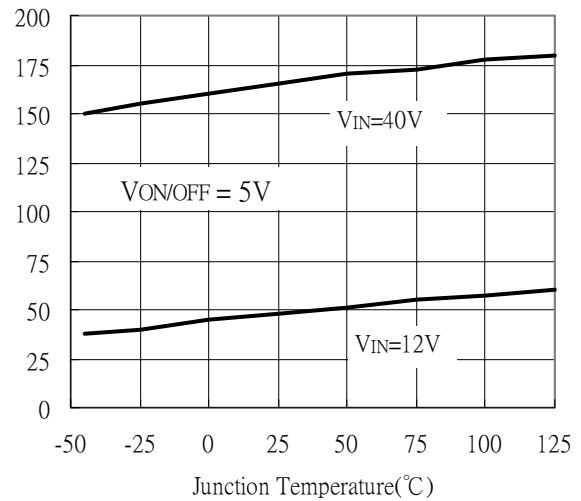

### Quiescent Current

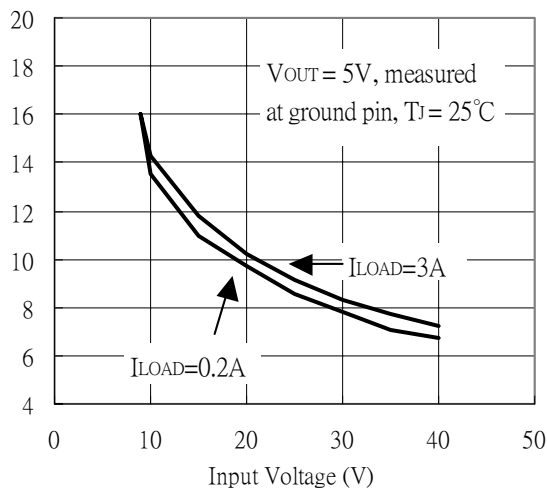

### Current Limit

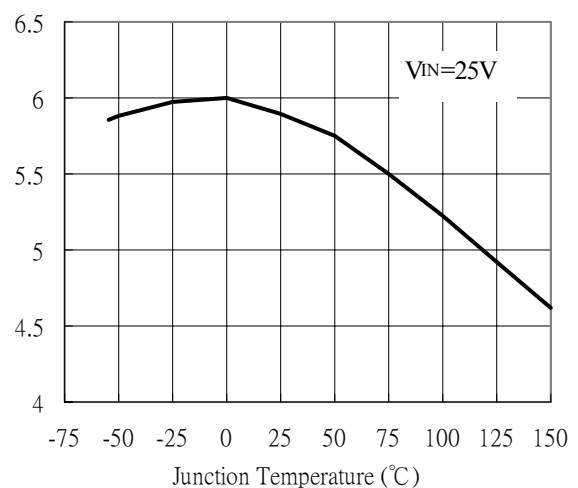



### Switch Saturation Voltage

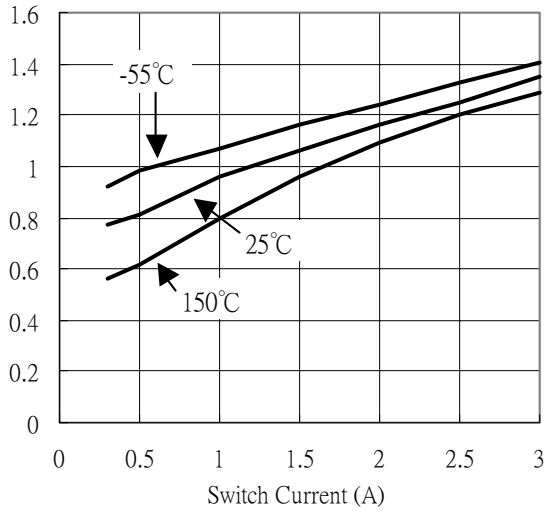

### Efficiency

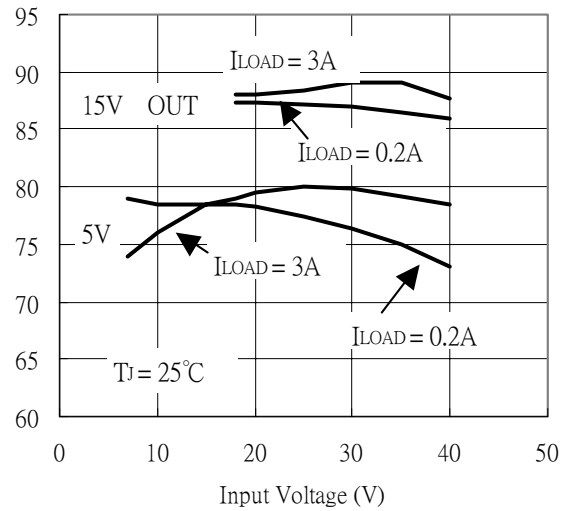

### Oscillator Frequency

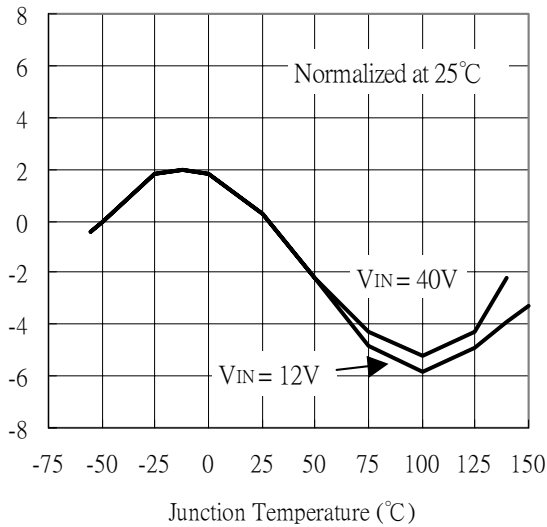

### Minimum Operating Voltage

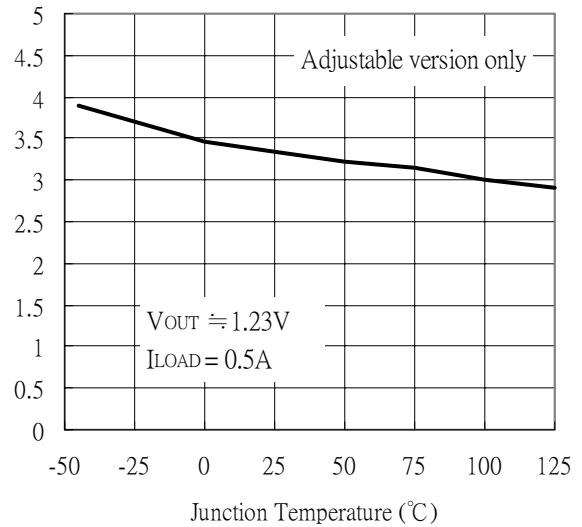

### Quiescent Current vs Duty Cycle

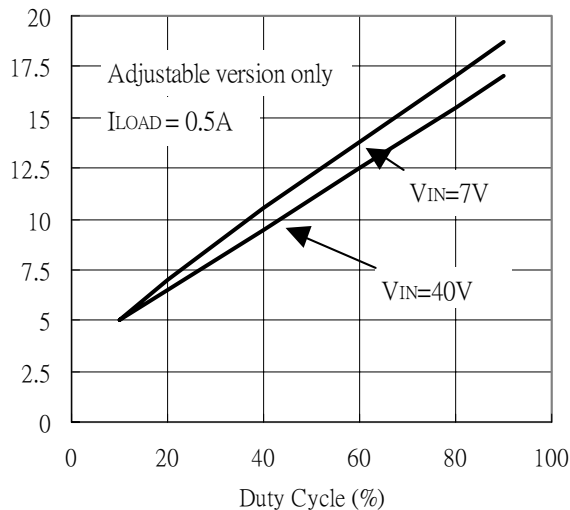

### Feedback Voltage vs Duty Cycle

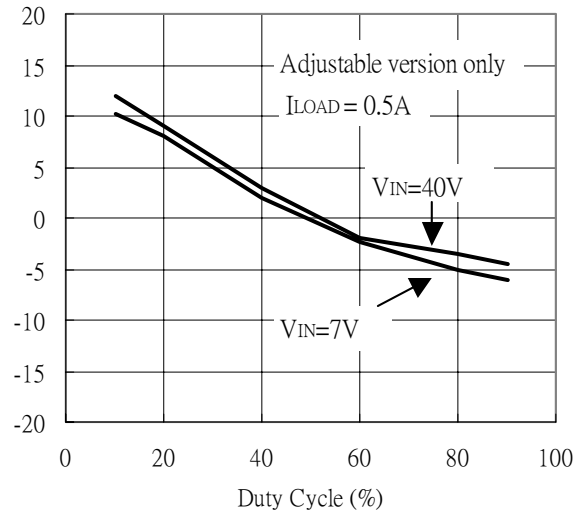

### Minimum Power Dissipation

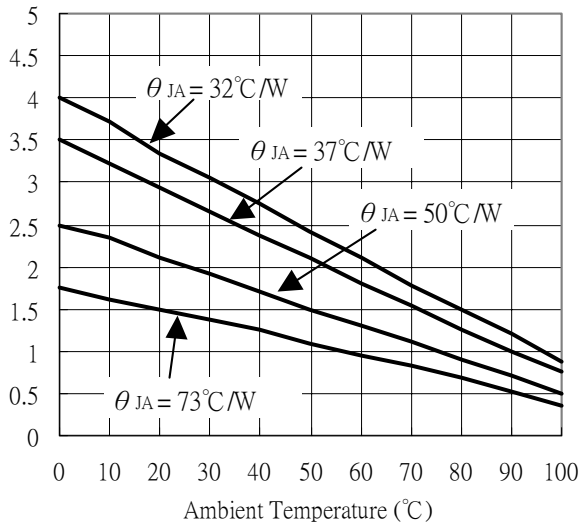

### Feedback Pin Current

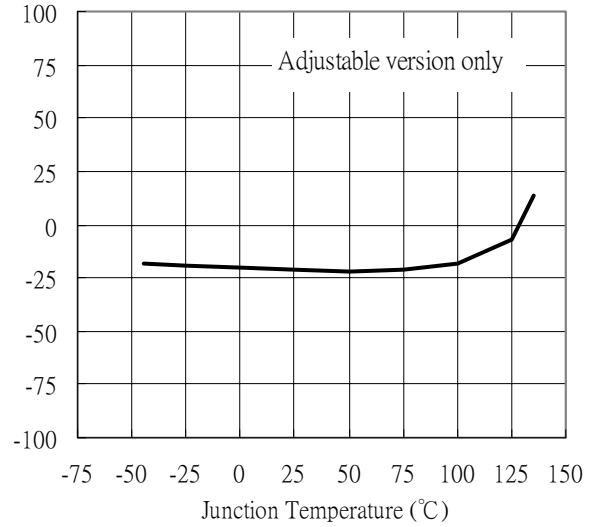

### Switching Waveforms

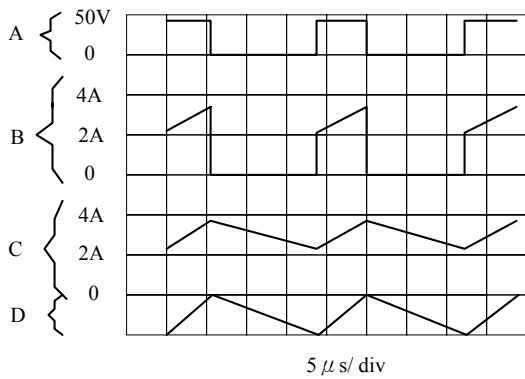

### Load Transient Response

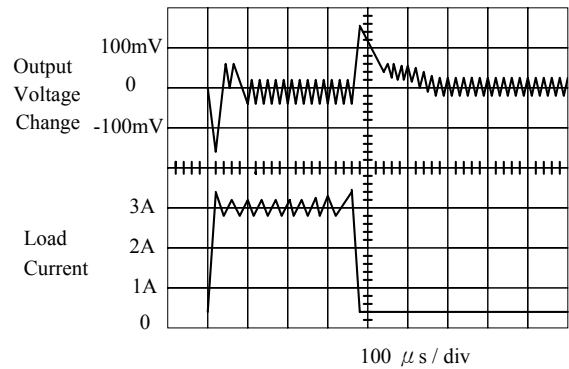

VOUT=15V

A : Output Pin Voltage, 50 V / div

B : Output Pin Current, 2A / div

C : Inductor Current, 2A / div

D : Output Ripple Voltage, 50mV / div

AC Coupled

Horizontal Time Base : 5  $\mu\text{s}$  / div



## Test Circuit and Layout Guidelines

As in any switching regulator, layout is very important. Rapidly switching currents associated with wiring inductance generate voltage transients which can cause problems. For minimal inductance and ground loops, the length of the leads indicated by heavy lines should be kept as short as possible. Single-point grounding (as indicated) or ground plane construction should be used for best results. When using the Adjustable version, physically locate the programming resistors near the regulator, to keep the sensitive feedback wiring short.

### Fixed Output Voltage Versions

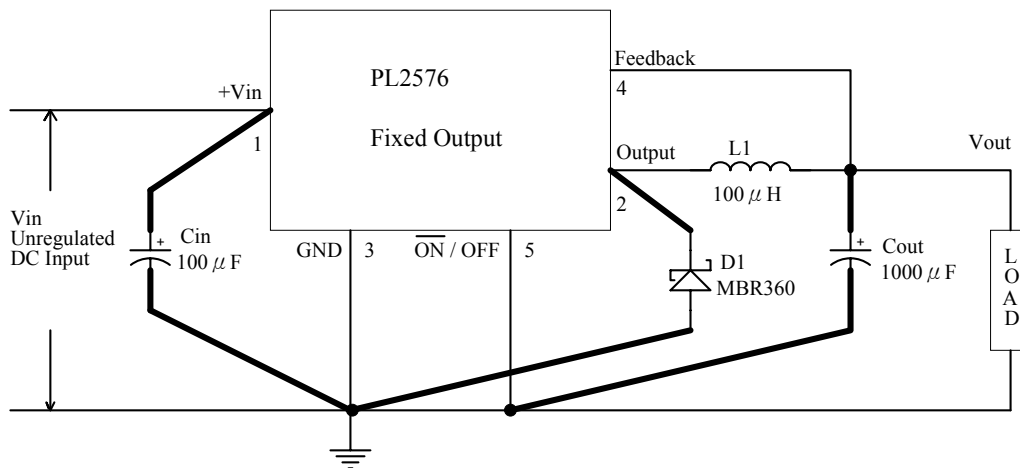

Cin--100 µF, 75V, Aluminum Electrolytic  
 Cout--1000 µF, 25V, Aluminum Electrolytic  
 D1--Schottky, MBR360  
 L1--100 µH, Pulse Eng, PE92108  
 R1--2k, 0.1%  
 R2--6.12k, 0.1%

### Adjustable Output Voltage Version

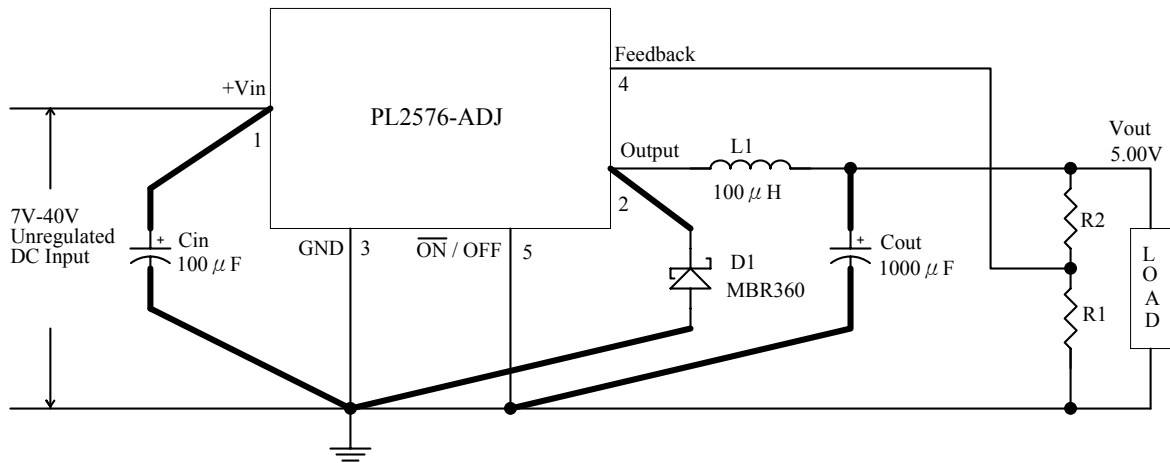

$$V_{out} = V_{REF} \left( 1 + \frac{R_2}{R_1} \right)$$

$$R_2 = R_1 \left( \frac{V_{out}}{V_{REF}} - 1 \right)$$

where VREF=1.23V, R1 between 1k and 5k

**Figure 2**

## TO-263-5L Dimension

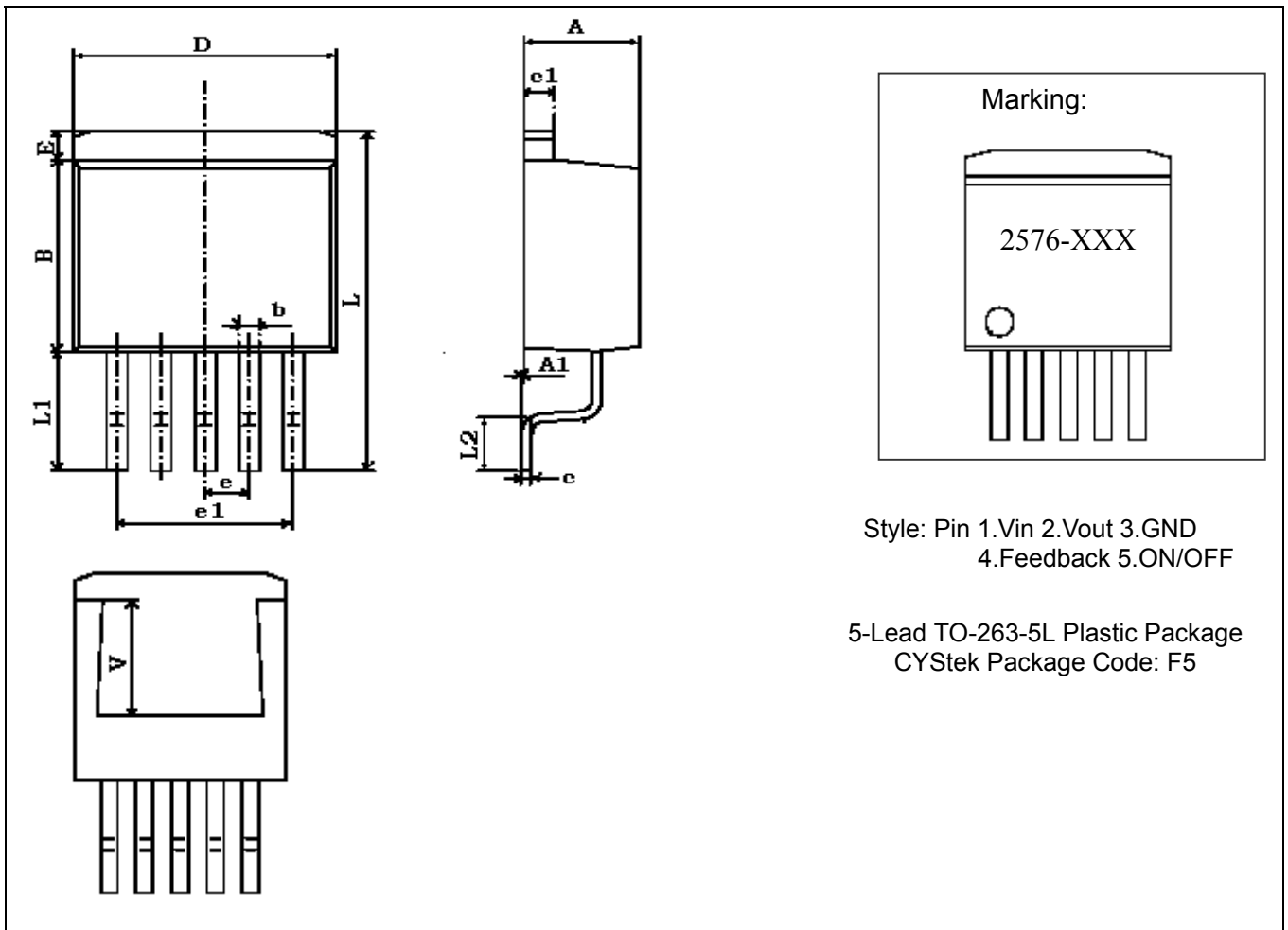

\*: Typical

DIM	Inches		Millimeters		DIM	Inches		Millimeters	
	Min.	Max.	Min.	Max.		Min.	Max.	Min.	Max.
A	0.176	0.184	4.47	4.67	E	0.323	0.339	0.820	0.860
A1	0	0.006	0	0.150	e	0.067(typical)		1.700(typical)	
B	0.061	0.069	1.560	1.760	e1	0.264	0.272	0.670	0.690
b	0.028	0.036	0.710	0.910	L	0.596	0.612	15.140	15.540
c	0.012	0.021	0.310	0.530	L1	0.200	0.216	5.080	5.480
c1	0.046	0.054	1.170	1.370	L2	0.092	0.108	2.340	2.740
D	0.389	0.401	9.880	10.180	V	0.220REF		5.600REF	

Notes: 1.Controlling dimension: inch

2.Maximum lead thickness includes lead finish thickness, and minimum lead thickness is the minimum thickness of base material.

3.If there is any question with packing specification or packing method, please contact your local CYStek sales office.

**Material:**

- Lead: 42 Alloy ; solder plating
- Mold Compound: Epoxy resin family, flammability solid burning class: UL94V-0

**Important Notice:**

- All rights are reserved. Reproduction in whole or in part is prohibited without the prior written approval of CYStek.
- CYStek reserves the right to make changes to its products without notice.
- CYStek **semiconductor products are not warranted to be suitable for use in Life-Support Applications, or systems.**
- CYStek assumes no liability for any consequence of customer product design, infringement of patents, or application assistance.