

# High Efficiency 4-Switch Buck-Boost Converter

## 1 Features

- Buck-Boost Controller for Step-Up/Step-Down DC/DC Conversion
- Dynamical programming of Output current and Output voltage using PWM signal or analog signal
- 2V to 32 V wide output range
- Comprehensive protection features including Output Short Protection (OSP), Cycle-by-Cycle input and output Peak Current Limit, thermal regulation, thermal shutdown, input UVLO, input OVP, output OVP etc.
- Adjustable Switching Frequency using resistor
- Frequency dithering for good EMI performance
- Integrated 2-A MOSFET Gate Drivers
- Integrated two 10mΩ power MOSFETs
- Input or Output Average Current Limiting with stable CC loop
- 5V/55mA low I<sub>q</sub> LDO to power system MCU
- Available in QFN5x5-32 Package

## 2 Applications

- Automotive Start-Stop Systems
- HUB Power
- Industrial PC Power Supplies
- USB Power Delivery
- Car charger

## 3 Description

PL94053 is a synchronous 4-switch Buck-Boost controller capable of regulating the output voltage at above or below the input voltage. PL94053 operates over a wide input voltage range of 3.6 V to 32 V (36 V maximum) to support a variety of applications. Integrated two 9mΩ power MOSFETs.

PL94053 employs Constant ON time control in buck, boost and buck-boost operation modes for superior load and line regulation. The switching frequency could be set to 150kHz, 300kHz, 600kHz or 1200kHz based on different resistor value between FREQ pin and GND pin. The device also features a programmable soft-start function and offers all kinds of protection features including cycle-by-cycle current limiting, input under voltage lockout (UVLO), output over voltage protection (OVP), input Over Voltage Protection, thermal shutdown and output short protection etc.

VADJ, IADJ pins are used to program output VBUS voltage and output current limit, provides voltage control loop, constant current loop, thermal regulation loop, temperature sensing, which makes PL94053 an excellent option for USB Power Delivery (PD) application.

## 4 Typical Application Schematic

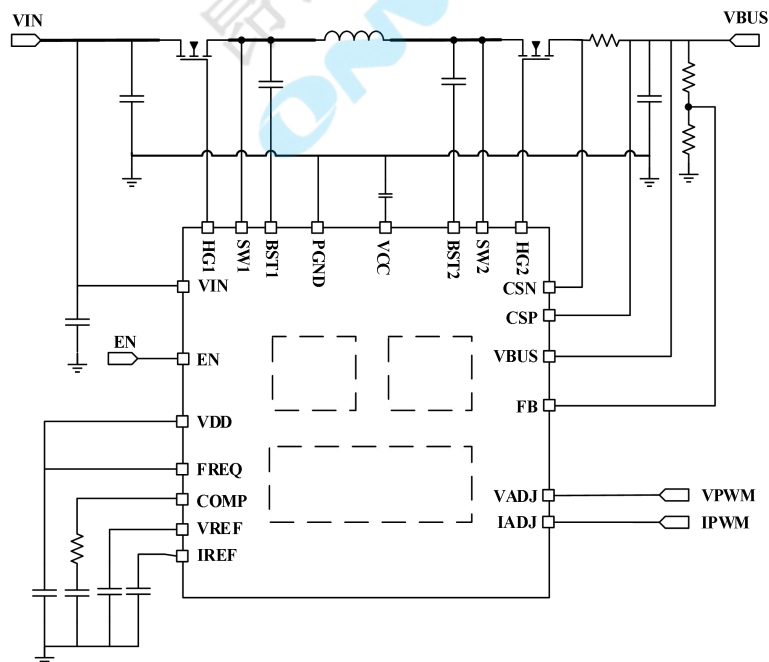

Fig. 1 Application Schematic

**5 Pin Configuration and Functions**

Fig. 2 Pin-Function (QFN5x5-32)

Pin		Description
Number	Name	
1	BST1	Boost pin for high side MOSFET driver1.
2	HG1	High side MOSFET driver 1.
3	VIN	Connect this pin to the Input voltage.
4,29	SW1	Connect this pin to the Switching point1 of the power stage.
5,20,24,25,26,30,31,32	PGND	Power ground.
6	EN	Logic High will enable the converter. Logic Low will disable the whole PL94053 except LDO. Only LDO is working to power system MCU when EN is low.
7	VDD	5.4V power supply for PL94053 control core.
8	VADJ	Connect a 0-2V analog voltage or a PWM signal to program voltage reference on VREF pin. Connect this pin to VDD will force VREF to constant 2V.
9	IADJ	Connect a 0-2V analog voltage or a PWM signal to program voltage reference on IREF pin. Connect this pin to VDD will force IREF to 2V.
10	IREF	Reference voltage for input and output current limiting loop.
11	VREF	Voltage reference for voltage control loop
12	LDO	Low quiescent current 5V/55mA LDO. Directly powered from VIN pin. LDO can be used as power supply for application processor such as MCU. When EN is low, only this LDO will be active to power MCU and keep low quiescent current for the whole system.

13	AGND	Analog ground. Connect PGND and AGND together at the thermal pad under IC.
14	FREQ	Connect to GND to set the switching frequency at 150kHz. Connect this pin to VDD to set switching frequency at 300kHz. Connect to a resistor divider between VDD and GND to set frequency to 600k and 1200k Hz.
15	COMP	Error Amplifier output.
16	FB	VBUS voltage feedback. Connect a resistor divider between VBUS and GND to FB to program VBUS voltage .
17	CSN	The minus input of output current sense.
18	CSP	The positive input of output current sense.
19	VBUS	Connect to the VBUS rail.
21,28	SW2	Connect this pin to the Switching point 2 of the power stage.
22	HG2	High side MOSFET driver 2.
23	BST2	Boost pin for high side MOSFET driver 2.
27	VCC	6.6V power supply for high side and low side driver.

## 6 Device Marking Information

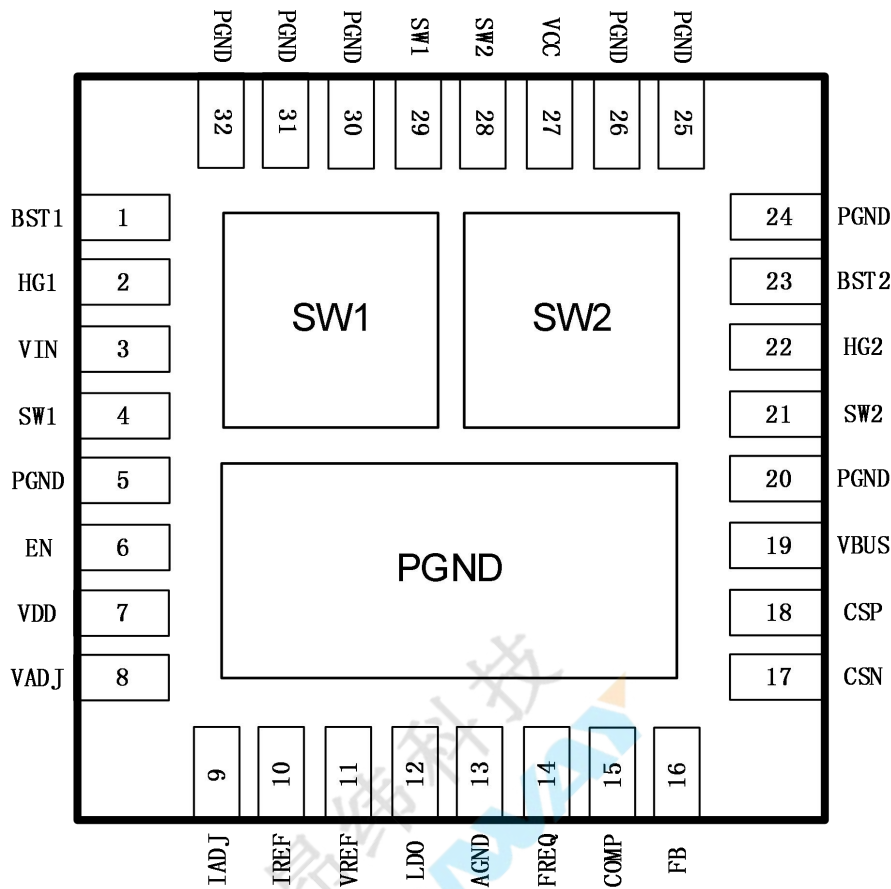
Order Information	Label Part NO.	Package	Package Qty	Top Marking
PL94053	PL94053IQN48A	QFN5x5 - 32	2500	94053 RAAYMD

**PL94053:** Part Number

**RAAYMD:** RAA: LOT NO.; YMD: Package Date Code

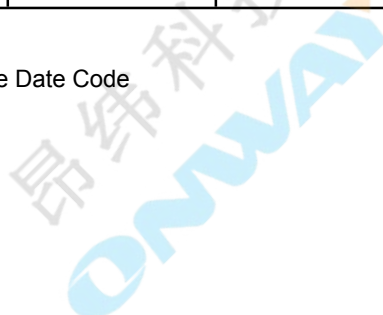

## 7 Specifications

### 7.1 Absolute Maximum Ratings<sup>(Note1)</sup>

PARAMETER	MIN	MAX	Unit
VIN, VBUS, CSN, CSN2, CSP, CSP2, SW1, SW2	-0.3	40	V
HG1, BST1 to SW1	-0.3	7	
HG2, BST2 to SW2	-0.3	7	
VCC to GND	-0.3	7	
CSP to CSN	-0.3	0.6	
VBUS to CSP, CSN	-0.3	0.6	
Other Pins to GND	-0.3	6	

### 7.2 Handling Ratings

PARAMETER	DEFINITION	MIN	MAX	UNIT
T <sub>ST</sub>	Storage Temperature Range	-65	150	°C
T <sub>J</sub>	Junction Temperature		+150	°C
T <sub>L</sub>	Lead Temperature		+260	°C
V <sub>ESD</sub>	HBM Human body model		2	kV

### 7.3 Recommended Operating Conditions<sup>(Note 2)</sup>

	PARAMETER	MIN	MAX	Unit
Input Voltages	VIN , VBUS	3.6	32	V
Temperature	Operating junction temperature range, T <sub>J</sub>	-40	+125	°C

### 7.4 Thermal Information<sup>(Note 3)</sup>

Symbol	Description	QFN5X5-32	Unit
θ <sub>JA</sub>	Junction to ambient thermal resistance	58	°C/W
θ <sub>JC</sub>	Junction to case thermal resistance	5	

**Notes:**

- 1) Exceeding these ratings may damage the device.
- 2) The device function is not guaranteed outside of the recommended operating conditions.
- 3) Measured on approximately 1" square of 1 oz copper.

**7.5 Electrical Characteristics** (Typical at VIN = 12V, T<sub>J</sub> = 25°C, unless otherwise noted.)

Supply voltages	PARAMETER	CONDITION	MIN	TYP	MAX	UNIT
VIN	VIN voltage		3.6		32	V
I <sub>Q_VIN</sub>	VIN Shutdown Current	EN=0V, VIN=7.2V		15		µA
	VIN Supply Current	No Switching, FB=2.1V		1000		µA
VBUS	Bus line voltage		3.6		32	V
V <sub>VCC</sub>	Driver power supply voltage	VIN =15V		6.6		V
V <sub>VDD</sub>	Control core power supply voltage	VIN =15V		5.4		V
V <sub>LDO</sub>	LDO output voltage	VIN =15V		5		V
I <sub>LDO</sub>	LDO output current	V <sub>LDO</sub> =5V			55	mA
<b>UVLO/EN</b>						
VIN <sub>UV</sub>	VIN UVLO Rising			3.5		V
	UVLO Hysteresis			300		mV
VBUS <sub>UV</sub>	VBUS UVLO Rising			3.5		V
	UVLO Hysteresis			300		mV
V <sub>EN_UV</sub>	Operation Threshold		1.1	1.2	1.3	V
	Hysteresis			200		mV
<b>VREF</b>						
V <sub>VREF</sub>	VREF voltage	VADJ connected to VDD		2		V
<b>Control loop</b>						
V <sub>FB</sub>	VFB regulation voltage in discharging mode	FB voltage		2		V
G <sub>mEA</sub>	Error amplifier gm			450		µS
I <sub>SINK</sub>	COMP sink/source current	VFB=VREF+100mV		15		µA
I <sub>SOURCE</sub>	COMP source current	VFB=VREF-100mV		20		µA
I <sub>FB</sub>	FB bias current	FB in regulation			100	nA
<b>Frequency</b>						
F <sub>SW</sub>	Switching Frequency	FREQ 0-0.4V, short FREQ pin to GND.		150		KHz
		FREQ 1.8-5.4V, short FREQ pin to VDD.		300		KHz
		FREQ 0.4-0.85V		600		KHz
		FREQ 0.85-1.8V		1200		KHz
<b>Current Limit</b>						
I <sub>CCLIM_BUS</sub>	Bus average current Limit, V <sub>CSP</sub> - V <sub>CSN</sub>	Discharging mode		40		mV
<b>NMOS Driver</b>						
I <sub>HDRV2</sub> (Note 4)	Driver peak source current	VBST-VSW=6.6V		2		A
	Driver peak sink current	VBST-VSW=6.6V		2		A
I <sub>LDRV2</sub> (Note 4)	Driver peak source current	VCC=6.6V		2		A
	Driver peak sink current	VCC=6.6V		2		A
R <sub>DSon_LS</sub>	Low side MOS on resistance	VCC=6.6V		10	15	mΩ
R <sub>DSon_LS</sub>	Low side MOS on resistance	VCC=6.6V		10	15	mΩ
V <sub>BSTUV</sub>	UVLO			2		V
	UVLO Hysteresis			300		mV
<b>Output Protection</b>						
V <sub>OVP</sub>	Output over voltage threshold			110		%
V <sub>UVP</sub>	Output under voltage threshold			50		%

VADJ, IADJ				
$V_{TH\_VADJ}$ (Note 4)	VPWM low voltage		0.4	V
	VPWM high voltage		2.5	V
$V_{TH\_IADJ}$ (Note 4)	IPWM low voltage		0.4	V
	IPWM high voltage		2.5	V
$T_{SD}$ (Note 4)	Thermal Shutdown Threshold		150	°C
$T_{HYS}$ (Note 4)	Thermal Shutdown Hysteresis		20	°C

**Notes:**

4) Guaranteed by design.



**8 Typical Characteristics**

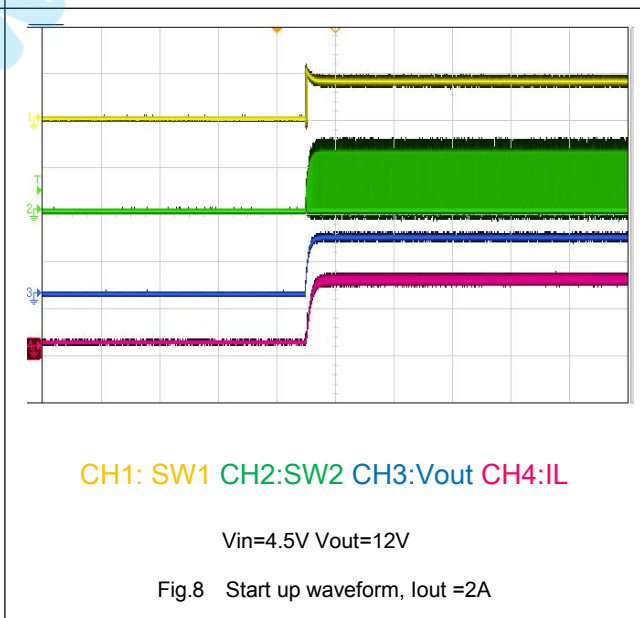
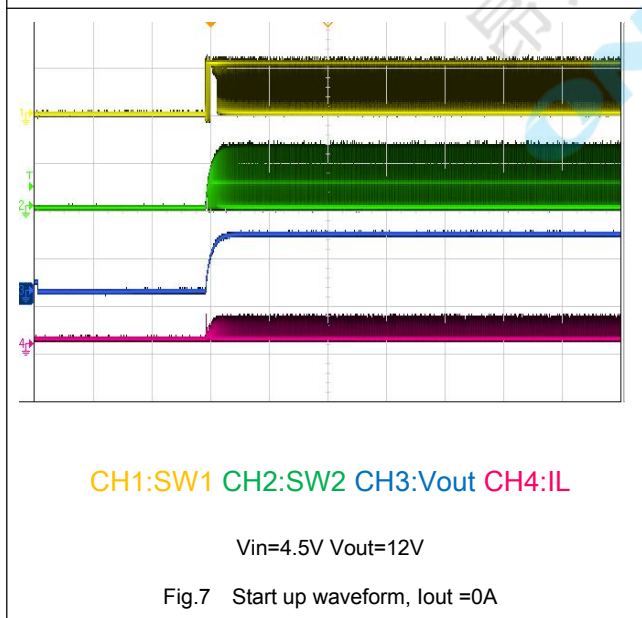
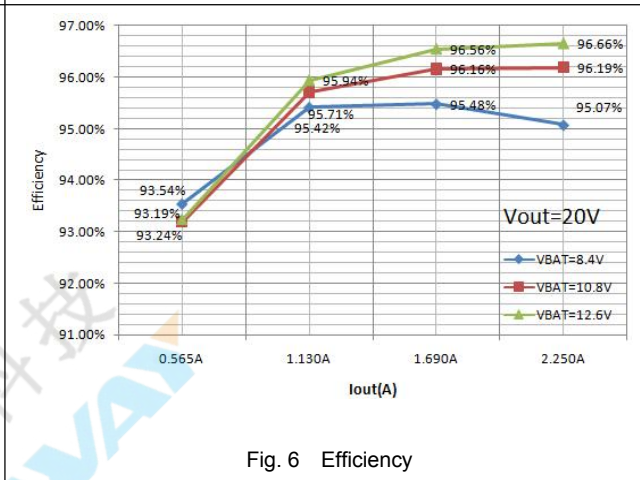
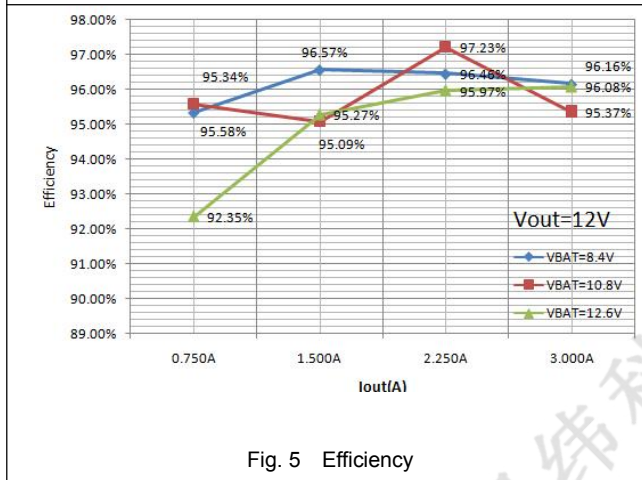
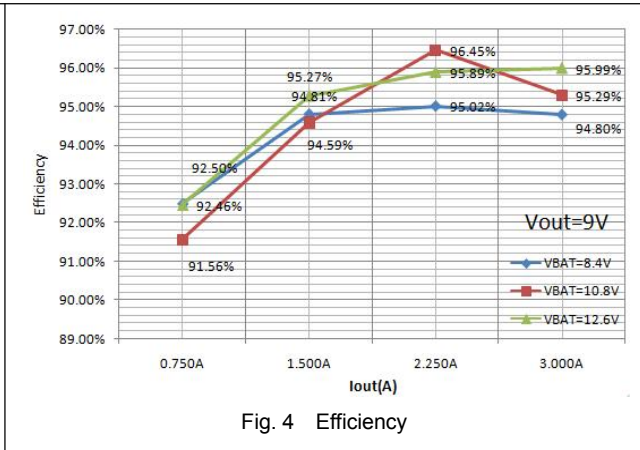
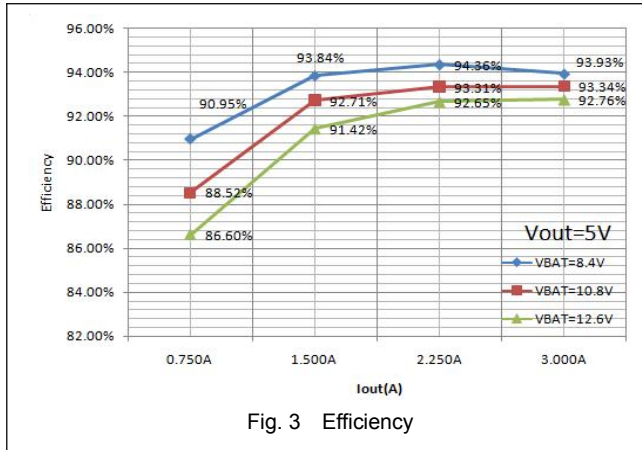

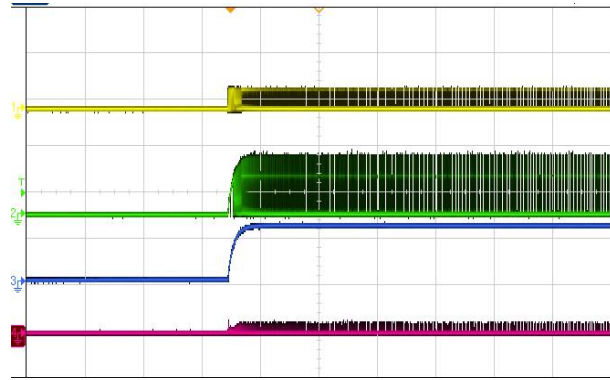

CH1: SW1 CH2:SW2 CH3:Vout CH4:IL

Vin=8.4V Vout=12V

Fig.9 Start up waveform, Iout =0A

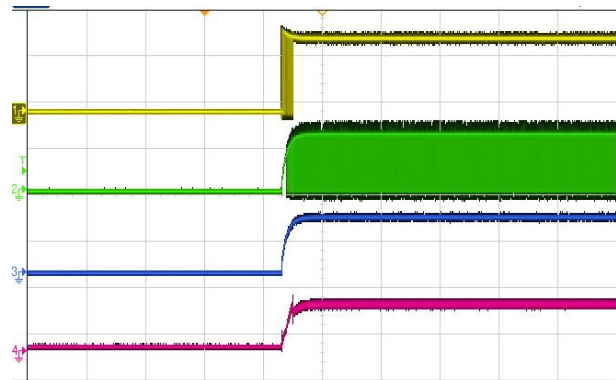

CH1: SW1 CH2:SW2 CH3:Vout CH4:IL

Vin=8.4V Vout=12V

Fig.10 Start up waveform, Iout =3A

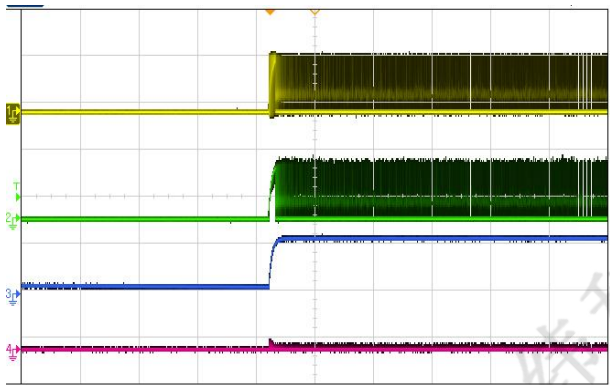

CH1: SW1 CH2:SW2 CH3:Vout CH4:IL

Vin=12V Vout=12V

Fig.11 Start up waveform, Iout =0A

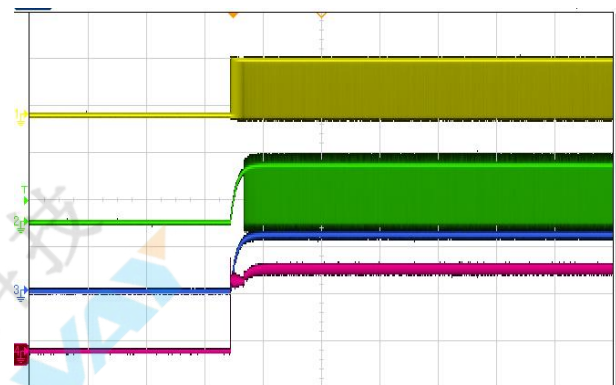

CH1: SW1 CH2:SW2 CH3:Vout CH4:IL

Vin=12V Vout=12V

Fig.12 Start up waveform, Iout =3A

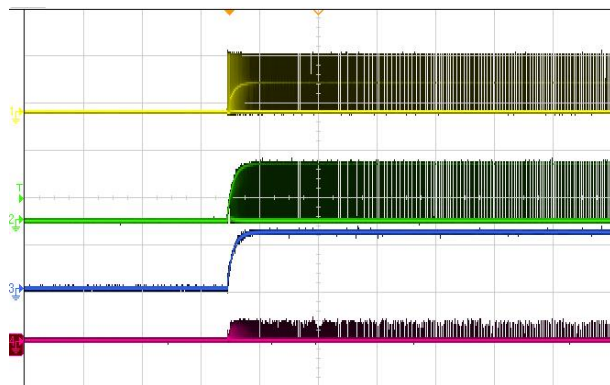

CH1:SW1 CH2:SW2 CH3:Vout CH4:IL

Vin=24V Vout=12V

Fig.13 Start up waveform, Iout =0A

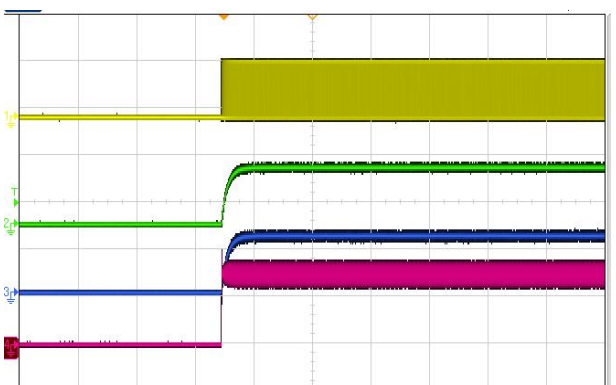

CH1: SW1 CH2:SW2 CH3:Vout CH4:IL

Vin=24V Vout=12V

Fig.14 Start up waveform, Iout =3A



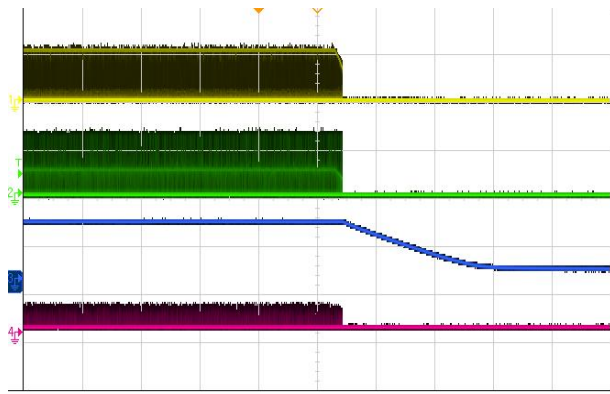

CH1: SW1 CH2:SW2 CH3:Vout CH4:IL

Vin=4.5V Vout=12V

Fig.15 Shut down waveform, Iout =0A

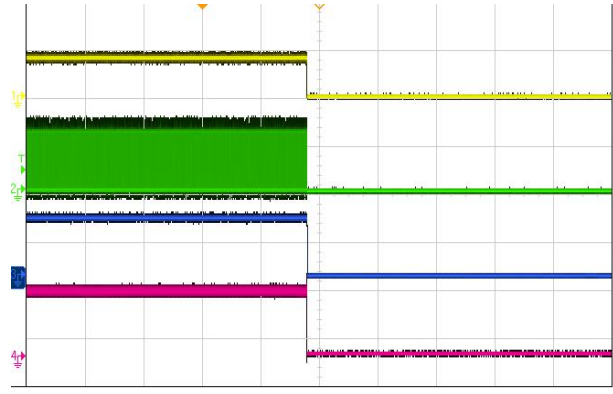

CH1: SW1 CH2:Vout CH3:SW CH4:IL

Vin=4.5V Vout=12V

Fig.16 Shut down waveform, Iout =2A

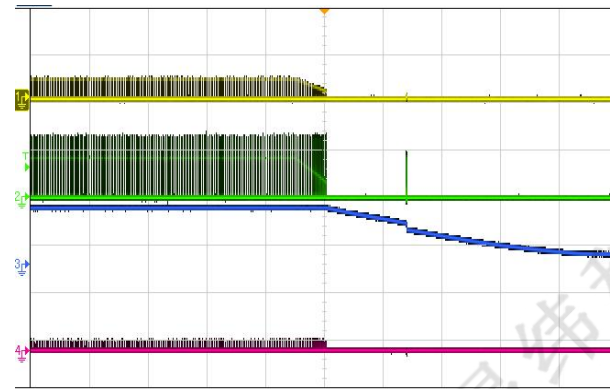

CH1: SW1 CH2:SW2 CH3:Vout CH4:IL

Vin=8.4V Vout=12V

Fig.17 Shut down waveform, Iout =0A

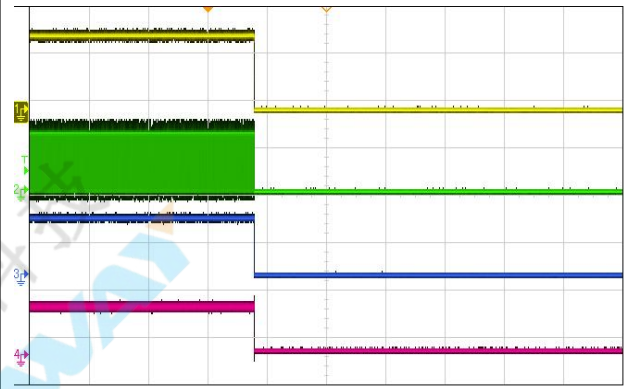

CH1: SW1 CH2:SW2 CH3:Vout CH4:IL

Vin=8.4V Vout=12V

Fig.18 Shut down waveform, Iout =3A

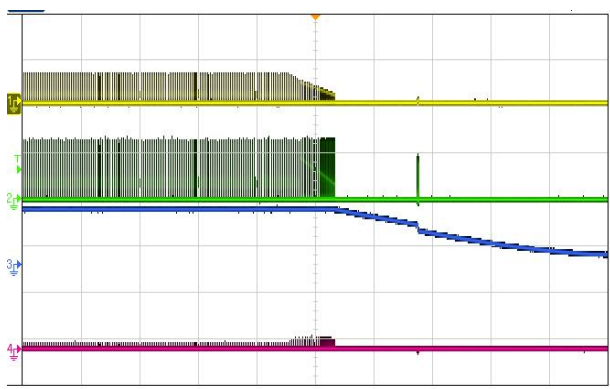

CH1: SW1 CH2:SW2 CH3:Vout CH4:IL

Vin=12V Vout=12V

Fig.19 Shut down waveform, Iout =0A

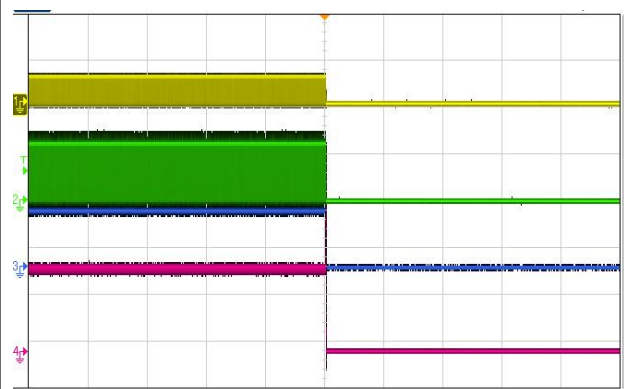

CH1: SW1 CH2:SW2 CH3:Vout CH4:IL

Vin=12V Vout=12V

Fig.20 Shut down waveform, Iout =3A

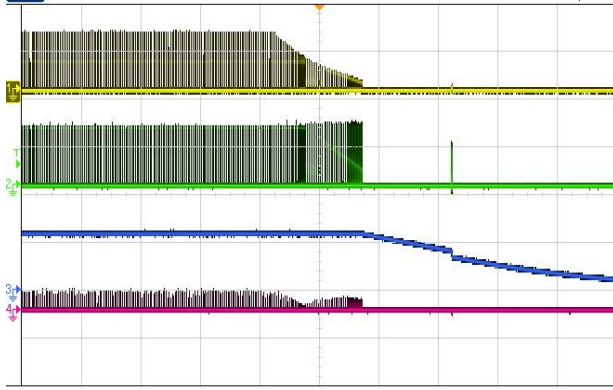

CH1: SW1 CH2:SW2 CH3:Vout CH4:IL

Vin=24V Vout=12V

Fig.21 Shut down waveform, Iout =0A

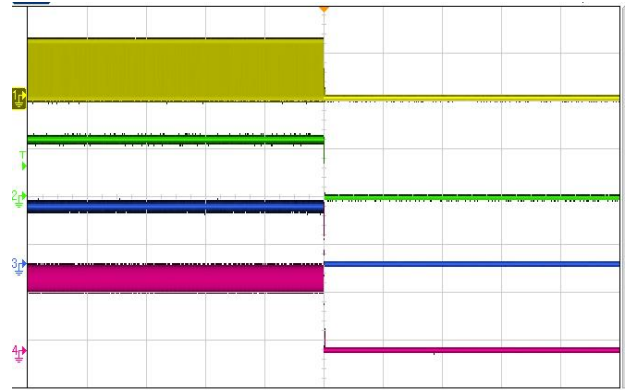

CH1: SW1 CH2:SW2 CH3:Vout CH4:IL

Vin=24V Vout=12V

Fig.22 Shut down waveform, Iout =3A

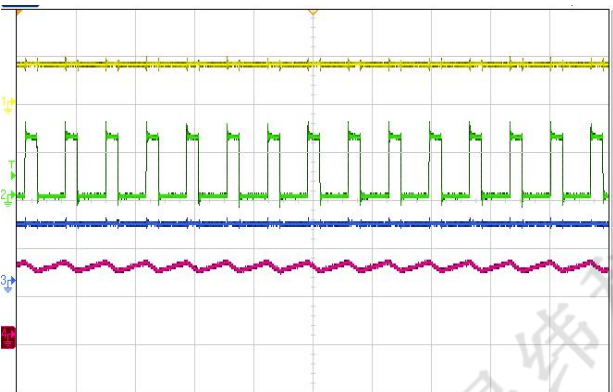

CH1: SW1 CH2:SW2 CH3:Vout CH4:IL

Vin=4.5V Vout=12V

Fig.23 Steady State, Iout =2A

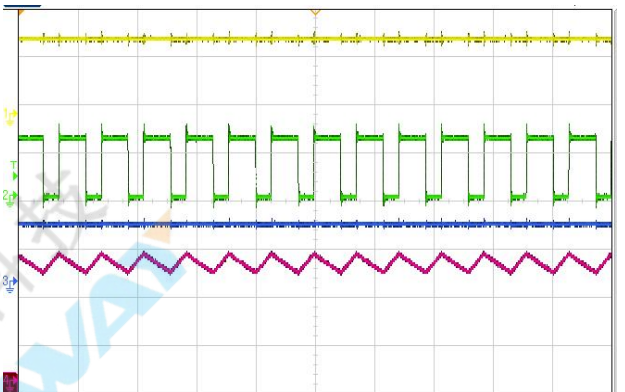

CH1: SW1 CH2:SW2 CH3:Vout CH4:IL

Vin=8.4V Vout=12V

Fig.24 Steady State, Iout =3A

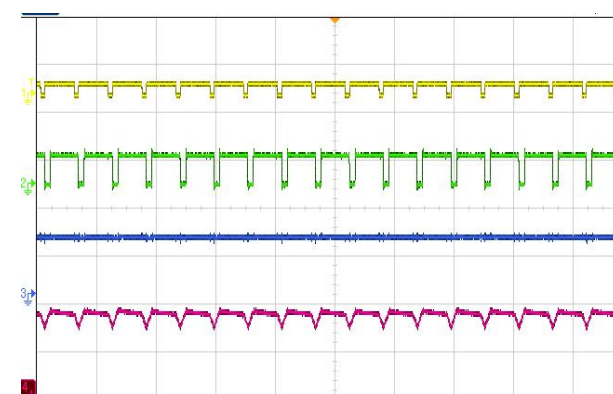

CH1: SW1 CH2:SW2 CH3:Vout CH4:IL

Vin=12V Vout=12V

Fig.25 Steady State, Iout =3A

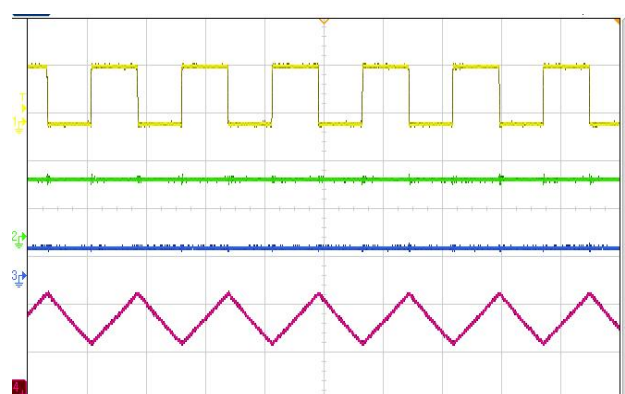

CH1: SW1 CH2:SW2 CH3:Vout CH4:IL

Vin=24V Vout=12V

Fig.26 Steady State, Iout =3A

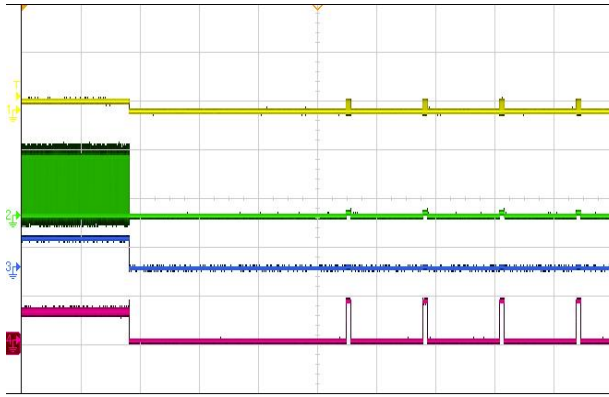

CH1: SW1 CH2:SW2 CH3:Vout CH4:IL

Vin=4.5V Vout=12V

Fig.27 Short Circuit waveform

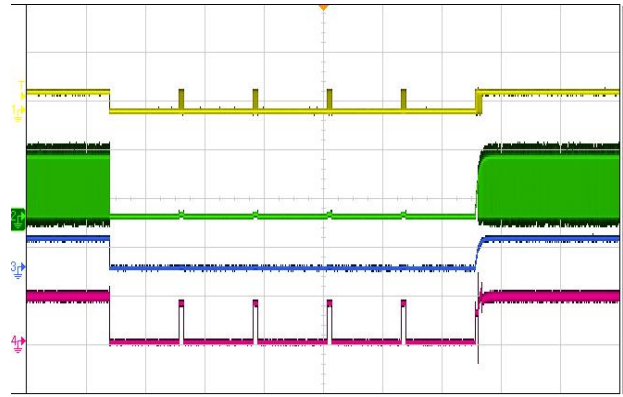

CH1: SW1 CH2:SW2 CH3:Vout CH4:IL

Vin=8.4V Vout=12V

Fig.28 Short Circuit waveform

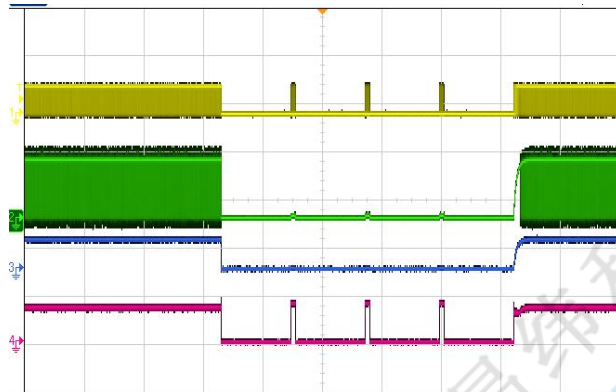

CH1: SW1 CH2:SW2 CH3:Vout CH4:IL

Vin=12V Vout=12V

Fig.29 Short Circuit waveform

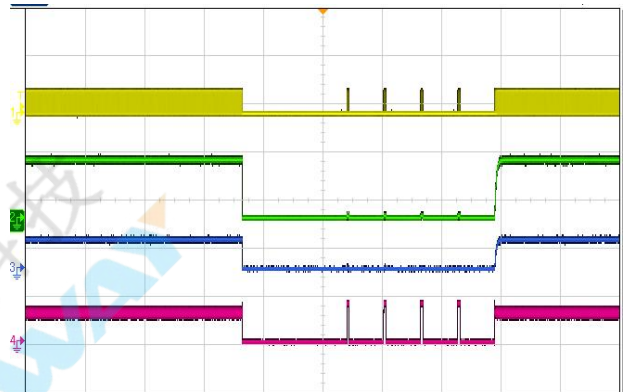

CH1: SW1 CH2:SW2 CH3:Vout CH4:IL

Vin=24V Vout=12V

Fig.30 Short Circuit waveform

## 9 Detailed Descriptions

### 9.1 Overview

PL94053 is a synchronous 4-switch bidirectional Buck-Boost controller capable of regulating the output voltage at, above, or below the input voltage. PL94053 operates over a wide input voltage range of 3.6 V to 32 V (36 V maximum) to support a variety of applications. Integrated two 10mΩ power MOSFETs. It operates in buck mode when  $V_{IN}$  is greater than  $V_{OUT}$  and in the boost mode when  $V_{IN}$  is less than  $V_{OUT}$ . When  $V_{IN}$  is close to  $V_{OUT}$ , the device operates in a proprietary buck-boost mode. The control scheme provides smooth operation for any input/output combination within the specified operating range.

### 9.2 Enable/UVLO

When EN is greater than 1.2V operating threshold, the control loop starts to work and regulate output to target voltage. When EN pin is below the standby threshold (1.1V typical), PL94053 stops working with only LDO is active to power MCU. EN is pulled high to 4V internally using a 2Meg resistor.

### 9.3 Over current Protection and short circuit protection

PL94053 provides cycle-by-cycle current limit to protect against over current and short circuit conditions. When VBUS is drop to UV threshold, PL94053 will go into hiccup mode to lower down power consumption.

### 9.4 Average Input/Output Current Limiting

PL94053 provides optional average current limiting capability to limit the output current. The average current limiting circuit uses an additional current sense resistor connected in series with the output voltage of the converter. A current sense gm amplifier with inputs at the CSP and CSN pins monitors the voltage across the sensing resistor and compares it with an internal 40 mV reference. If the drop across the sense resistor is greater than 40 mV, the gm amplifier regulates COMP voltage to lower down output current. The target constant current is given by Equation 1:

$$I_{CL(AVG)} = \frac{40 \text{ mV}}{R_{SNS}} \quad (1)$$

### 9.5 Frequency Setting (FREQ) and frequency dithering

PL94053 switching frequency can be programmed at 150 kHz, 300 kHz or 600 kHz and 1200 kHz by voltage at FREQ pin to GND. When FREQ is connected to AGND, the switching frequency is set at 150 kHz. When FREQ is connected to VDD, the switching frequency is set at 300 kHz. A voltage divider between VDD and GND pin can be used to program switching frequency if 600 kHz or 1200 kHz is required.

### 9.6 Integrated MOSFETs and Gate Drivers

PL94053 Integrated two 9mΩ power MOSFETs, provides two N-channel MOSFET gate drivers: one floating high-side gate drivers at the HG1 pins, and one floating high-side gate drivers at the HG2 pins. Each driver is capable of sourcing 2 A and sinking 2 A peak current. In buck operation, External High side MOSFETs and Internal Low side MOSFETs by the PWM controller while HG2 remains continuously on. In boost operation, Internal Low side MOSFETs and HG2 are switched while External High side MOSFETs remains continuously on. In DCM buck operation, Internal Low side MOSFETs and HG2 are turned off when the inductor current drops to zero (diode emulation).

The gate drive output HG2 remains off before the first high side switch is turned on to prevent reverse current flow from a pre-biased output.

### 9.7 Thermal Shutdown

PL94053 is protected by a thermal shutdown circuit that shuts down the device when the internal junction temperature exceeds 160°C (typical). The soft-start capacitor is discharged when thermal shutdown is triggered and the gate drivers are disabled. The converter automatically restarts when the junction temperature drops by the thermal shutdown hysteresis of 15°C below the thermal shutdown threshold.

### 9.8 VREF and IREF

VREF pin is the final reference voltage used in the voltage regulation loop. When VADJ is connected to VDD, VREF will be 2V. When VADJ is connected to a PWM signal, PWM signal will first be chopped to 2V and filter out using an internal resistor and external capacitor on VREF pin. The capacitor on VREF pin is also acting as soft-start capacitor at power up or in output voltage transition period. It is recommend using a relatively large capacitor such as 470nF for VREF pin and IREF pin.

The same mechanism works for IADJ and IREF pin.

## 10 Applications and Implementation

The typical application on the first page is a basic PL94053 application circuit. External component selection is driven by the load requirement, and begins with the selection of RS1 and the inductor value. Next, the power MOSFETs need to be selected. Finally, C<sub>IN</sub> and C<sub>OUT</sub> are selected. This circuit can be configured for operation up to an input voltage of 30V.

### 10.1 R<sub>CS</sub> Selection

As shown in Figures 32, output current sense resistor RCS1 should be placed between the bulk capacitor for VBUS and the decoupling capacitor. A low pass filter formed by RF and CF is recommended to reduce the switching noise and stabilize the current loop. Place CSP/CSN symmetrically and keep them away switching signals such as BST1, BST2, SW1, SW2, VIN, VBUS etc.

### 10.2 Inductor Selection

The operating frequency and inductor selection are interrelated in that higher operating frequencies allow the use of smaller inductor and capacitor values. The inductor value has a direct effect on ripple current. The inductor current ripple  $\Delta I_L$  is typically set to 20% to 40% of the maximum inductor current in the boost region at V<sub>IN(MIN)</sub>.

For a given ripple, the inductance terms in continuous mode are as follows:

$$L_{\text{BOOST}} > \frac{V_{\text{IN(MIN)}}^2 * (V_{\text{OUT}} - V_{\text{IN(MIN)}}) * 1000}{f * \Delta I_L * V_{\text{OUT}}^2} \text{ uH} \quad (3)$$

$$L_{\text{BUCK}} > \frac{V_{\text{OUT}} * (V_{\text{IN(MAX)}} - V_{\text{OUT}}) * 1000}{f * \Delta I_L * V_{\text{IN(MAX)}}} \text{ uH} \quad (4)$$

where: f is operating frequency, kHz

V<sub>IN(MIN)</sub> is minimum input voltage, V

V<sub>IN(MAX)</sub> is maximum input voltage, V

V<sub>OUT</sub> is output voltage, V

$\Delta I_L$  is maximum inductor ripple current, A, usually select 20~40% maximum output current.

For high efficiency, choose an inductor with low core loss, such as ferrite. Also, the inductor should have low DC resistance to reduce the I<sup>2</sup>R losses, and must be able to handle the peak inductor current without saturating. To minimize radiated noise, use a toroid, pot core or shielded bobbin inductor.

### 10.3 C<sub>IN</sub> and C<sub>OUT</sub> Selection

In the boost region, input current is continuous. In the buck region, input current is discontinuous. In the buck region, the selection of input capacitor C<sub>IN</sub> is driven by the need to filter the input square wave current. Use a low ESR capacitor sized to handle the maximum RMS current. For buck operation, the input RMS current is given by:

$$I_{\text{CIN}} = I_{\text{OUT(MAX)}} * \sqrt{\frac{V_{\text{OUT}}}{V_{\text{IN}}} * \left(1 - \frac{V_{\text{OUT}}}{V_{\text{IN}}}\right)} \quad (5)$$

This input current has a maximum at V<sub>IN</sub> = 2V<sub>OUT</sub>, I<sub>CIN(MAX)</sub> = I<sub>OUT(MAX)</sub>/2.

In the boost region, C<sub>OUT</sub> must be capable of reducing the output voltage ripple because of the discontinuous output current. The effects of ESR (equivalent series resistance) and the bulk capacitance must be considered when choosing the right capacitor for a given output ripple voltage. The steady ripple due to charging and discharging the bulk capacitance is given by:

$$\Delta V_{\text{(BOOST, Cap)}} = \frac{I_{\text{OUT(MAX)}} * (V_{\text{OUT}} - V_{\text{IN(MIN)}})}{C_{\text{OUT}} * V_{\text{OUT}} * f} \text{ V} \quad (6)$$

where C<sub>OUT</sub> is the output filter capacitor.

The steady ripple due to the voltage drop across the ESR is given by:

$$\Delta V_{\text{(BOOST, ESR)}} = I_{\text{OUT(MAX, BOOST)}} * \text{ESR} \quad (7)$$

In buck mode, V<sub>OUT</sub> ripple is given by:

$$\Delta V_{\text{OUT}} \leq \Delta I_L * \left( \text{ESR} + \frac{1}{8 * f * C_{\text{OUT}}} \right) \quad (8)$$

Multiple capacitors placed in parallel may be needed to meet the ESR and RMS current handling requirements.

#### 10.4 Power MOSFET Selection and Efficiency Considerations

PL94053 requires four external N-channel power MOSFETs, two for the top switches (switches Q1 and Q3, shown in Figure 32) and two for the bottom switches (switches Q2 and Q4, shown in Figure 32). Important parameters for the power MOSFETs are the breakdown voltage  $V_{BR, DSS}$ , threshold voltage  $V_{GS, TH}$ , on-resistance  $R_{DS(ON)}$ , reverse transfer capacitance  $C_{RSS}$  and maximum current  $I_{DS(MAX)}$ . The drive voltage is set by the 6.6V VCC supply to make the MOSFET's selection more flexible.

#### 10.5 Output voltage setting

The PL94053 output voltage is set by an external feedback resistive divider carefully placed across the output capacitor. The 1% resistance accuracy of this resistor divider is preferred. The resultant feedback signal is compared with the internal precision 2V voltage reference by the error amplifier. The output voltage is given by the equation:

$$V_{OUT} = 2V * \left(1 + \frac{R_1}{R_2}\right) \quad (9)$$

Where  $R_1$  is the upper resistor and  $R_2$  is the lower resistor in the feedback network.



## 11 PCB Layout

### 11.1 Guideline

Layout is a critical portion of good power supply design. The following guidelines will help users design a PCB with the best power conversion performance, thermal performance, and minimized generation of unwanted EMI.

1. The feedback network, resistor R1 and R2, should be kept close to the FB pin. Keep VBUS sensing path away from noisy nodes and preferably through a layer on the other side of shielding layer.
2. The input /output bypass capacitor must be placed as close as possible to the VIN/VBUS pin and ground. Grounding for both the input and output capacitors should consist of localized top side planes that connect to the GND pin and PAD. It is a good practice to place a ceramic cap near the VIN and VBUS pin to reduce the high frequency injection current.
3. The inductor L should be placed close to the SW1 and SW2 pin to reduce magnetic and electrostatic noise.
4. Current sensing pairs (CSP, CSN) need to be placed carefully, Layout the lines symmetrically and keep them away from noisy nodes such as BST1, BST2, SW1, SW2, HG2, etc. Connect these nodes directly to the two terminals of current sensing resistors Rcs1 to form an accurate Kelvin connection.

### 11.2 Application Examples

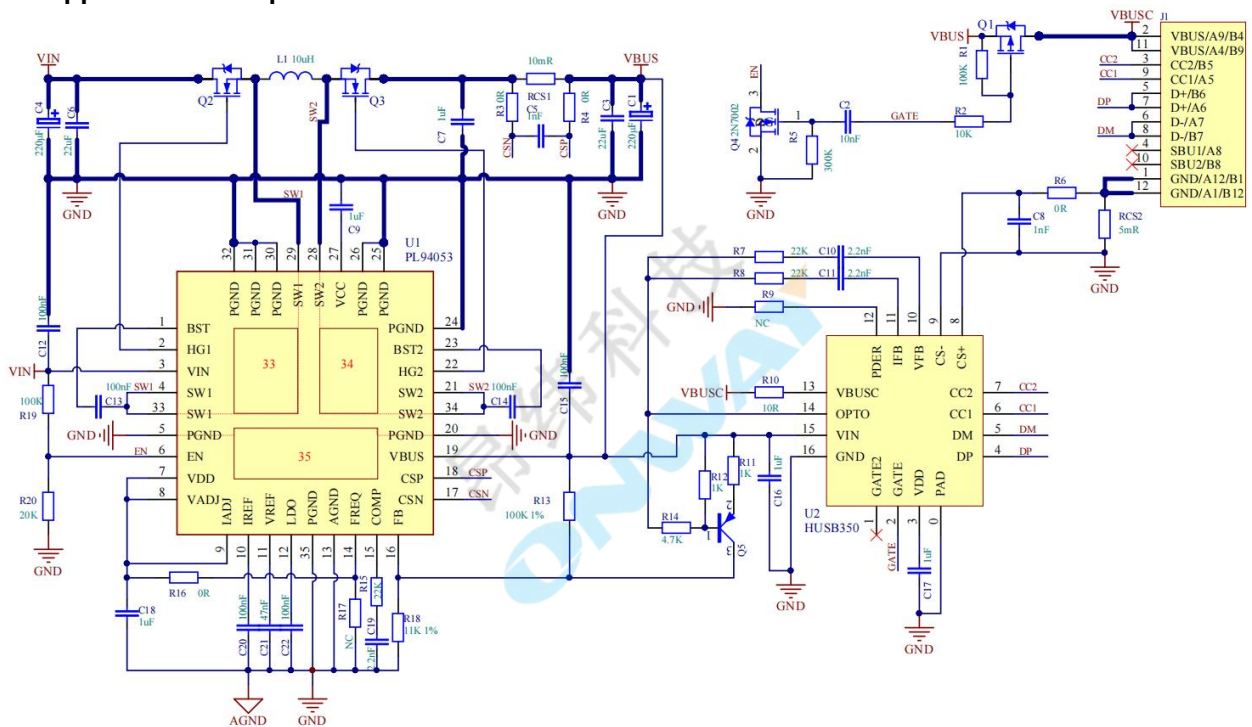

Fig. 32 Schematic

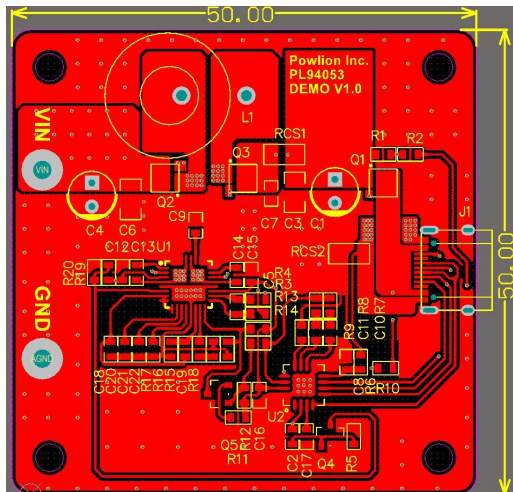

Fig. 33 Top lay

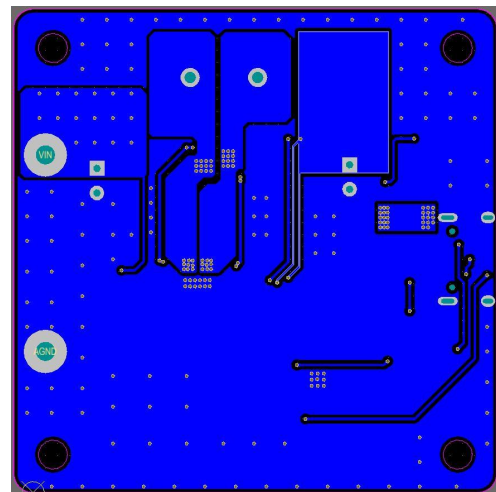
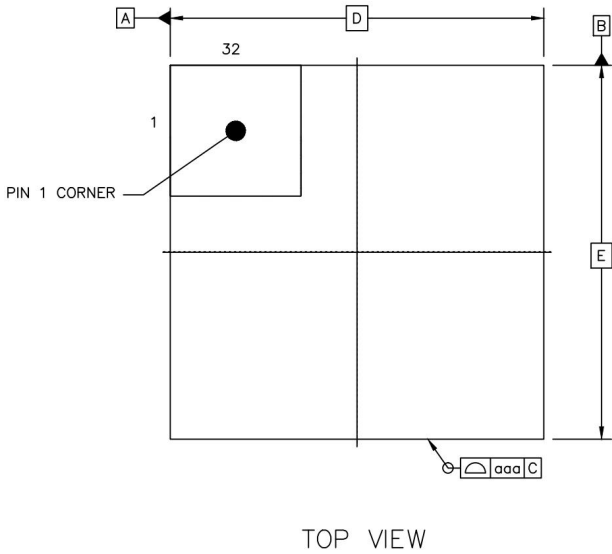
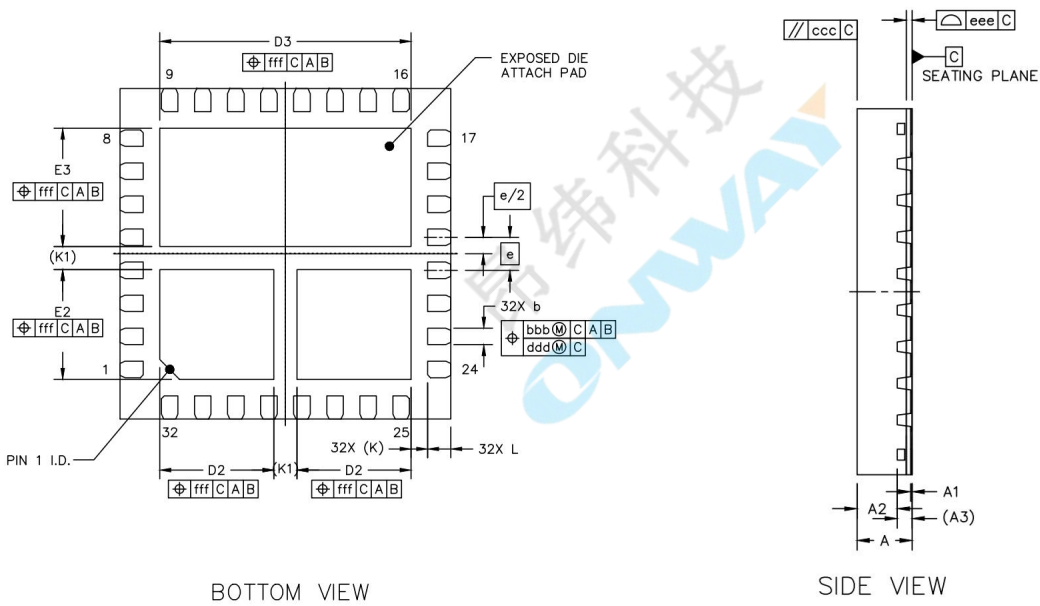

Fig. 34 Bottom lay

**12 Packaging Information**

	SYMBOL	MIN	NOM	MAX
TOTAL THICKNESS	A	0.7	0.75	0.8
STAND OFF	A1	0	0.02	0.05
MOLD THICKNESS	A2	---	0.55	---
L/F THICKNESS	A3	0.203 REF		
LEAD WIDTH	b	0.2	0.25	0.3
BODY SIZE	X	5 BSC		
	Y	5 BSC		
LEAD PITCH	e	0.5 BSC		
EP SIZE	X	D2	1.625	1.725
	Y	E2	1.56	1.66
	X	D3	3.7	3.8
	Y	E3	1.69	1.79
LEAD LENGTH	L	0.25	0.35	0.45
LEAD TIP TO EXPOSED PAD EDGE	K	0.25 REF		
	K1	0.35 REF		
PACKAGE EDGE TOLERANCE	aaa	0.1		
MOLD FLATNESS	ccc	0.1		
COPLANARITY	eee	0.08		
LEAD OFFSET	bbb	0.1		
	ddd	0.05		
EXPOSED PAD OFFSET	fff	0.1		

**IMPORTANT NOTICE**

Powlicon Inc. assumes no responsibility for any error which may appear in this document. Powlicon Inc. reserves the right to change devices or specifications detailed herein at any time without notice. Powlicon Inc. does not assume any liability arising out of the application or use of any product described herein; neither it does it convey any license under its patent rights, nor the rights of others. Powlicon Inc. products are not authorized for use as critical components in life support devices or systems without written approval letter from the Chief Executive Officer of Powlicon Inc. The use of products in such applications shall assume all risks of such use and will agree to not hold against Powlicon Inc. for any damage.



13 Version Control

版本	日期	撰写	页数	更新说明
Rev.1.0	2022-03-04	Victor	17	首次发布

