



	PLA192	Units
Load Voltage	600	V
Load Current	150	mA
Max R _{ON}	22	Ω

Features

- 5000V_{RMS} Input/Output Isolation
- Small 6 Pin DIP Package
- Low Drive Power Requirements (TTL/CMOS Compatible)
- No Moving Parts
- High Reliability
- Arc-Free With No Snubbing Circuits
- No EMI/RFI Generation
- Machine Insertable, Wave Solderable
- 600 volt blocking

Applications

- Instrumentation
 - Multiplexers
 - Data Acquisition
 - Electronic Switching
 - I/O Subsystems
 - Meters (Watt-Hour, Water, Gas)
- Medical Equipment—Patient/Equipment Isolation
- Security
- Aerospace
- Industrial Controls

Description

The PLA192 is a 1-Form-A solid state relay that uses optically coupled relay technology to provide an enhanced 5000V isolation barrier between the input and output of the relay. The efficient MOSFET switches use Clares patented OptoMOS® architecture. The optically coupled input is controlled by a highly efficient GaAIAs infrared LED.

Approvals

- UL Approved to UL1577
- CSA Certified
- Complies with EN60950

Ordering Information

Part #	Description
PLA192	6 Pin Dip (50/Tube)
PLA192S	6 Pin Surface Mount (50/Tube)
PLA192STR	6 Pin Surface Mount (1000/Reel)

Pin Configuration

PLA192 Pinout

AC/DC Configuration

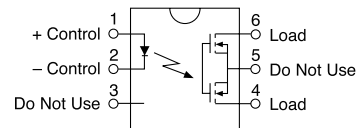

PLA192 Pinout

DC Only Configuration

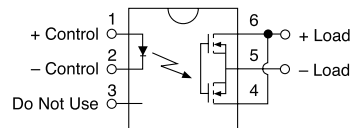

Switching Characteristics of Normally Open (Form A) Devices

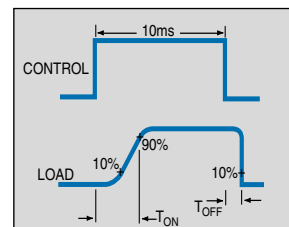

Absolute Maximum Ratings (@ 25° C)

Parameter	Min	Typ	Max	Units
Input Power Dissipation	-	-	150 ¹	mW
Input Control Current	-	-	50	mA
Peak (10ms)	-	-	1	A
Reverse Input Voltage	-	-	5	V
Total Power Dissipation	-	-	800 ²	mW
Peak Blocking Voltage	-	-	600	V
Isolation Voltage Input to Output (60 seconds)	5000	-	-	V _{RMS}
Operational Temperature	-40	-	+85	°C
Storage Temperature	-40	-	+125	°C
Soldering Temperature DIP Package	-	-	+260	°C
Surface Mount Package (10 Seconds Max.)	-	-	+220	°C

¹ Derate Linearly 1.33 mw/°C

² Derate Linearly 6.67 mw/°C

Absolute Maximum Ratings are stress ratings. Stresses in excess of these ratings can cause permanent damage to the device. Functional operation of the device at conditions beyond those indicated in the operational sections of this data sheet is not implied.

Electrical Characteristics

Parameter	Conditions	Symbol	Min	Typ	Max	Units
Output Characteristics @ 25°C						
Load Current (Continuous) AC/DC Configuration	-	I_L	-	-	150	mA
DC Configuration	-	I_L	-	-	220	mA
Peak Load Current	10ms	I_{LPK}	-	-	350	mA
On-Resistance* AC/DC Configuration	$I_L=150\text{mA}$	R_{ON}	-	-	22	Ω
DC Configuration	$I_L=220\text{mA}$		-	-	8	Ω
Off-State Leakage Current	$V_L=600\text{V}$	I_{LEAK}	-	-	1	μA
Switching Speeds						
Turn-On	$I_F=5\text{mA}, V_L=10\text{V}$	T_{ON}	-	-	5	ms
Turn-Off	$I_F=5\text{mA}, V_L=10\text{V}$	T_{OFF}	-	-	5	ms
Output Capacitance	50V; f=1MHz	C_{OUT}	-	50	-	pF
Input Characteristics @ 25°C						
Input Control Current	$I_L=100\text{mA}$	I_F	5	-	50	mA
Input Dropout Current	-	I_F	0.4	0.7	-	mA
Input Voltage Drop	$I_F=5\text{mA}$	V_F	0.9	1.2	1.4	V
Reverse Input Voltage	-	V_R	-	-	5	V
Reverse Input Current	$V_R=5\text{V}$	I_R	-	-	10	μA
Common Characteristics @ 25°C						
Input to Output Capacitance	-	$C_{I/O}$	-	3	-	pF

* Within 1 second of on time

PERFORMANCE DATA*

PLA192
Typical LED Forward Voltage Drop
(N=50 Ambient Temperature = 25°C)
 $I_F = 5\text{mADC}$

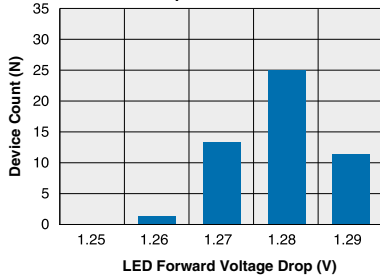

PLA192
Typical On-Resistance Distribution
(N=50 Ambient Temperature = 25°C)
(Load Current = 150mADC; $I_F = 5\text{mADC}$)

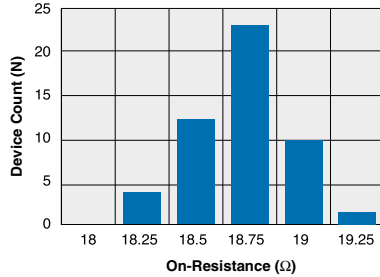

PLA192
Typical Blocking Voltage Distribution
(N=50 Ambient Temperature = 25°C)

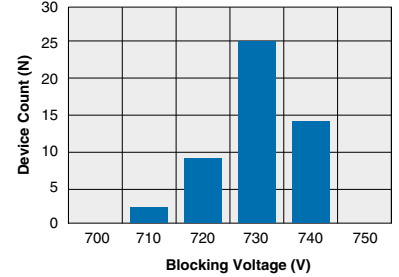

PLA192
Typical I_F for Switch Operation
(N=50 Ambient Temperature = 25°C)
(Load Current = 150mADC)

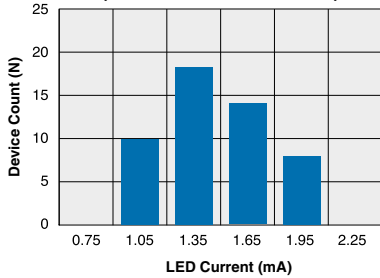

PLA192
Typical I_F for Switch Dropout
(N=50 Ambient Temperature = 25°C)

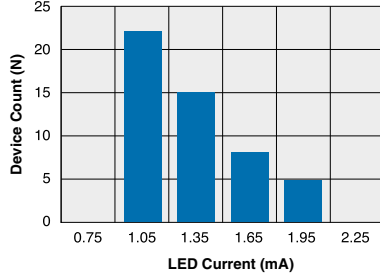

PLA192
Typical Turn-On Time
(N=50 Ambient Temperature = 25°C)
(Load Current = 100mADC; $I_F = 5\text{mADC}$)

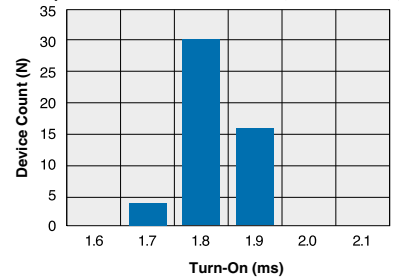

PLA192
Typical Turn-Off Time
(N=50 Ambient Temperature = 25°C)
(Load Current = 100mADC; $I_F = 5\text{mADC}$)

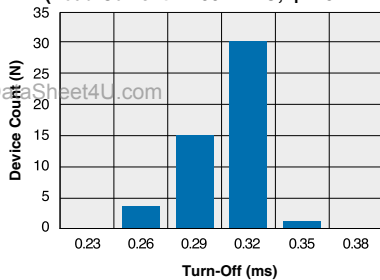

PLA192
Maximum Load Current vs. Temperature

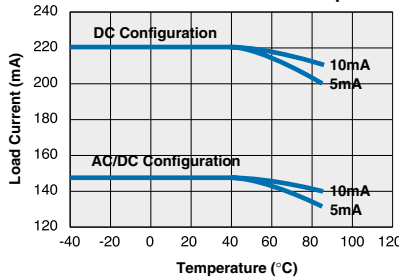

PLA192
Typical On-Resistance vs. Temperature
(Load Current = Max Rated at Temp.)
DC Configuration

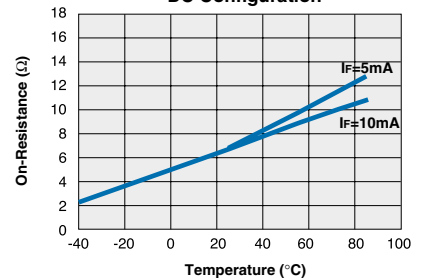

PLA192
Typical On Resistance vs. Temp.
Load Current=100mA Instantaneous

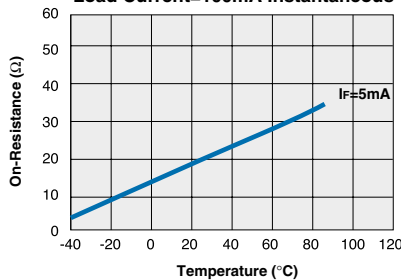

PLA192
Typical Leakage vs. Temperature
(Measured across Pins 4 & 6)

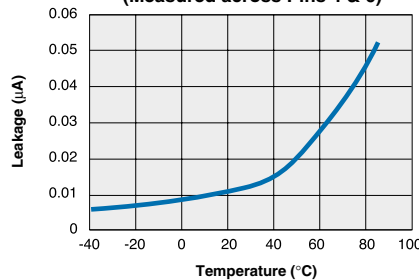

PLA192
Typical Blocking Voltage vs. Temperature

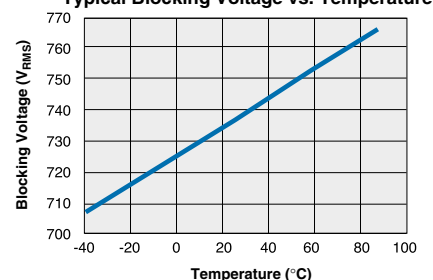

*The Performance data shown in the graphs above is typical of device performance. For guaranteed parameters not indicated in the written specifications, please contact our application department.

PERFORMANCE DATA*

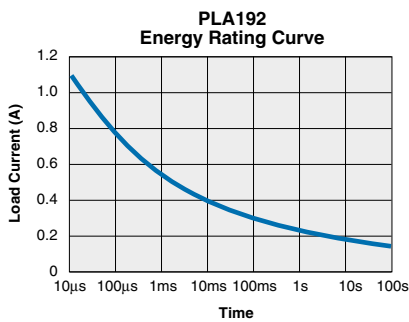
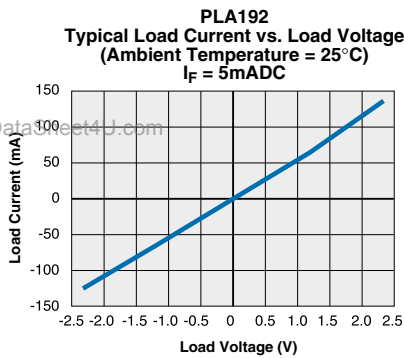
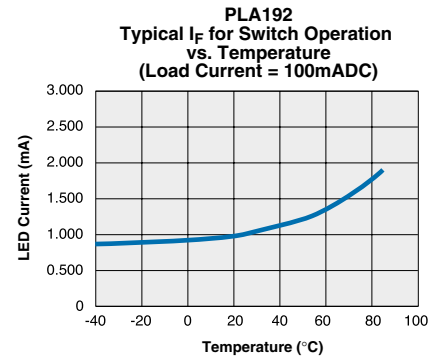
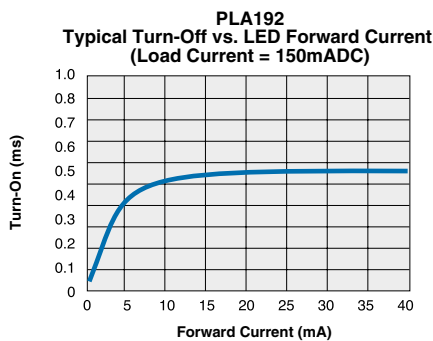
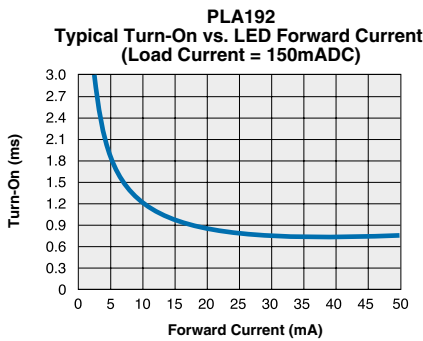
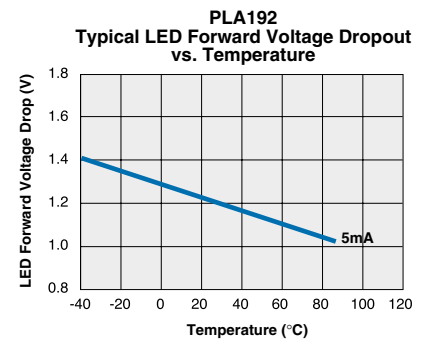
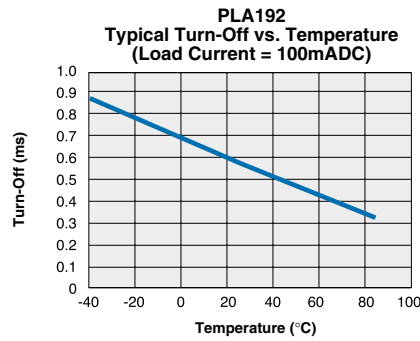
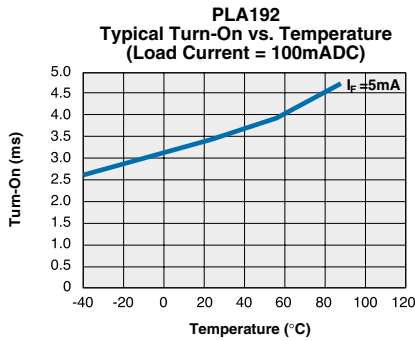

*The Performance data shown in the graphs above is typical of device performance. For guaranteed parameters not indicated in the written specifications, please contact our application department.



MECHANICAL DIMENSIONS

6Pin DIP Through Hole (Standard)

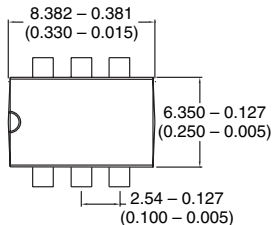
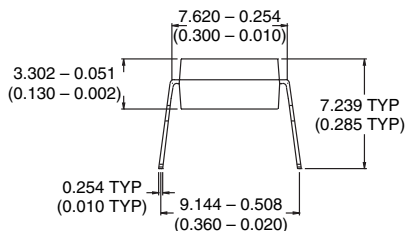

PC Board Pattern (Top View)

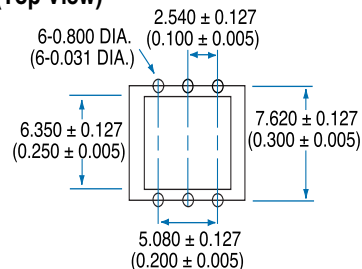

6Pin DIP Surface Mount ("S" Suffix)

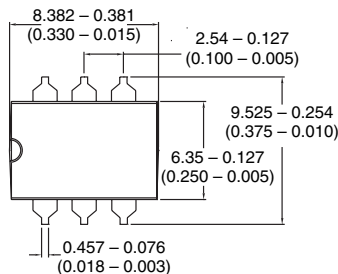
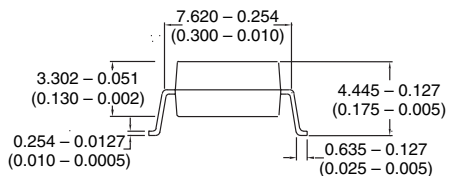

PC Board Pattern (Top View)

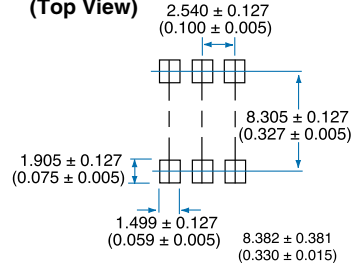

Tape and Reel Packaging for 6 Pin Power DIP Surface Mount Package

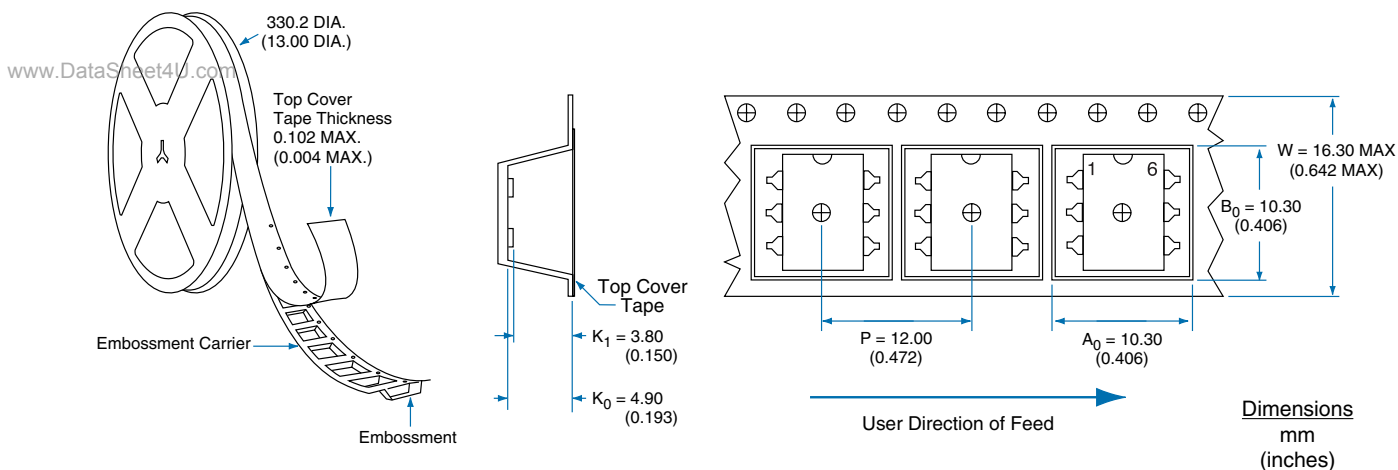

For additional information please visit our website at: www.clare.com

Clare, Inc. makes no representations or warranties with respect to the accuracy or completeness of the contents of this publication and reserves the right to make changes to specifications and product descriptions at any time without notice. Neither circuit patent licenses nor indemnity are expressed or implied. Except as set forth in Clare's Standard Terms and Conditions of Sale, Clare, Inc. assumes no liability whatsoever, and disclaims any express or implied warranty, relating to its products including, but not limited to, the implied warranty of merchantability, fitness for a particular purpose, or infringement of any intellectual property right.

The products described in this document are not designed, intended, authorized or warranted for use as components in systems intended for surgical implant into the body, or in other applications intended to support or sustain life, or where malfunction of Clare's product may result in direct physical harm, injury, or death to a person or severe property or environmental damage. Clare, Inc. reserves the right to discontinue or make changes to its products at any time without notice.