

ATTENTION
OBSERVE PRECAUTIONS
FOR HANDLING
ELECTROSTATIC
DISCHARGE
SENSITIVE
DEVICES

Part No./型号: PLCC6W3

1、Features/特征:

- I Emitting Color/发光颜色: White/白色
- I Lens Type/封装特性: Yellow Diffused/黄色散射
- I Device Outline/外形特征: 5.5×5.0×1.95 (unit:mm)
- I RoHS compliant/符合 RoHS 标准

2、Applications/应用:

- I Backlight for Mobile, Machine Vision, LCD Display/手机、电话、显示屏背光源
- I Backlight in Dashboard and switch of Automive/汽车仪表盘、记程器背光源

3、Outline Dimensions/产品外形尺寸:

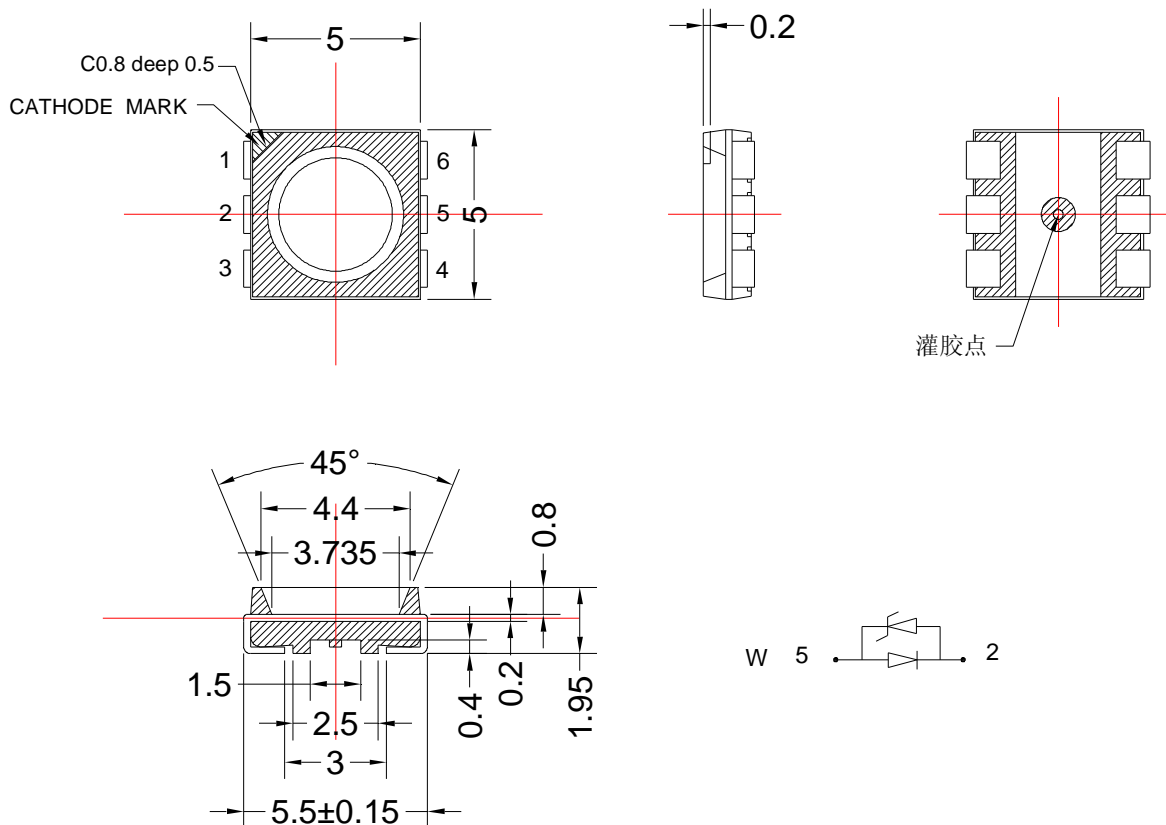

4、Absolute maximum ratings/极限参数 (Ta = 25°C):

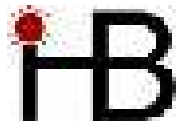

Part No./型号: PLCC6W3

Parameter 参数	Symbol 符号	Test Condition 测试条件	Value 参数		Unit 单位
			Min.	Max.	
Power Dissipation 损耗功率	Pd	—	—	90	mW
Reverse Voltage 反向电压	VR	IR = 30 μ A	5	—	V
Pulse Current 正向峰值电流	IFp	Duty=0.1, 1kHz	—	100	mA
Forward Current 正向工作电流	IFm	—	—	25	mA
Operating Temperature 工作温度范围	Topr	—	-40	+85	°C
Storage Temperature 储存温度范围	Tstr	—	-40	+85	°C

5、Electrical and optical characteristics/光电参数 (Ta = 25°C):

Parameter 参数	Symbol 符号	Test Condition 测试条件	Value 参数			Unit 单位
			Min.	Typ.	Max.	
Forward Voltage 正向电压	VF	IF = 20mA	—	3.2	3.6	V
Reverse Current 反向电流	IR	VR = 5V	—	—	30	μ A
Chromaticity coordinates 色坐标	CIE-X	IF = 20mA	—	---	—	-----
	CIE-Y			---		
Luminous Intensity 发光强度	Iv	IF = 20mA	1100	1500	—	mcd
Viewing Angle 发光指向角	2 θ 1/2	IF = 20mA	—	120	—	Deg.

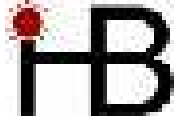

Part No./型号: PLCC6W3

6、Chromaticity coordinates Ranks /色坐标分档:

色坐标误差: ±0.01

代码	轴	参数				代码	轴	参数			
We1	X	0.400	0.424	0.417	0.395	We2	X	0.395	0.417	0.412	0.391
	Y	0.440	0.452	0.433	0.423		Y	0.423	0.433	0.417	0.408
We3	X	0.391	0.412	0.406	0.386	We4	X	0.386	0.406	0.399	0.381
	Y	0.408	0.417	0.399	0.390		Y	0.390	0.399	0.379	0.371
We5	X	0.381	0.399	0.393	0.376	We6	X	0.376	0.393	0.385	0.370
	Y	0.371	0.379	0.361	0.354		Y	0.354	0.361	0.337	0.331
We7	X	0.424	0.447	0.439	0.417	We8	X	0.417	0.439	0.431	0.412
	Y	0.452	0.462	0.442	0.433		Y	0.433	0.442	0.426	0.417
We9	X	0.412	0.431	0.423	0.406	We10	X	0.406	0.423	0.414	0.399
	Y	0.417	0.426	0.406	0.399		Y	0.399	0.406	0.385	0.379
We11	X	0.399	0.414	0.406	0.393	We12	X	0.393	0.406	0.395	0.385
	Y	0.379	0.385	0.367	0.361		Y	0.361	0.367	0.342	0.337
We13	X	0.447	0.466	0.457	0.439	We14	X	0.439	0.457	0.449	0.431
	Y	0.462	0.470	0.451	0.442		Y	0.442	0.451	0.433	0.426
We15	X	0.431	0.449	0.440	0.423	We16	X	0.423	0.440	0.431	0.414
	Y	0.426	0.433	0.414	0.406		Y	0.406	0.414	0.392	0.385
We17	X	0.414	0.431	0.422	0.406	We18	X	0.406	0.422	0.411	0.395
	Y	0.385	0.392	0.374	0.367		Y	0.367	0.374	0.348	0.342
We19	X	0.466	0.486	0.476	0.457	We20	X	0.457	0.476	0.467	0.449
	Y	0.470	0.479	0.459	0.451		Y	0.451	0.459	0.441	0.433
We21	X	0.449	0.467	0.457	0.440	We22	X	0.440	0.457	0.446	0.431
	Y	0.433	0.441	0.421	0.414		Y	0.414	0.421	0.399	0.392
We23	X	0.431	0.446	0.437	0.422	We24	X	0.422	0.437	0.424	0.411
	Y	0.392	0.399	0.380	0.374		Y	0.374	0.380	0.354	0.348

Diagram

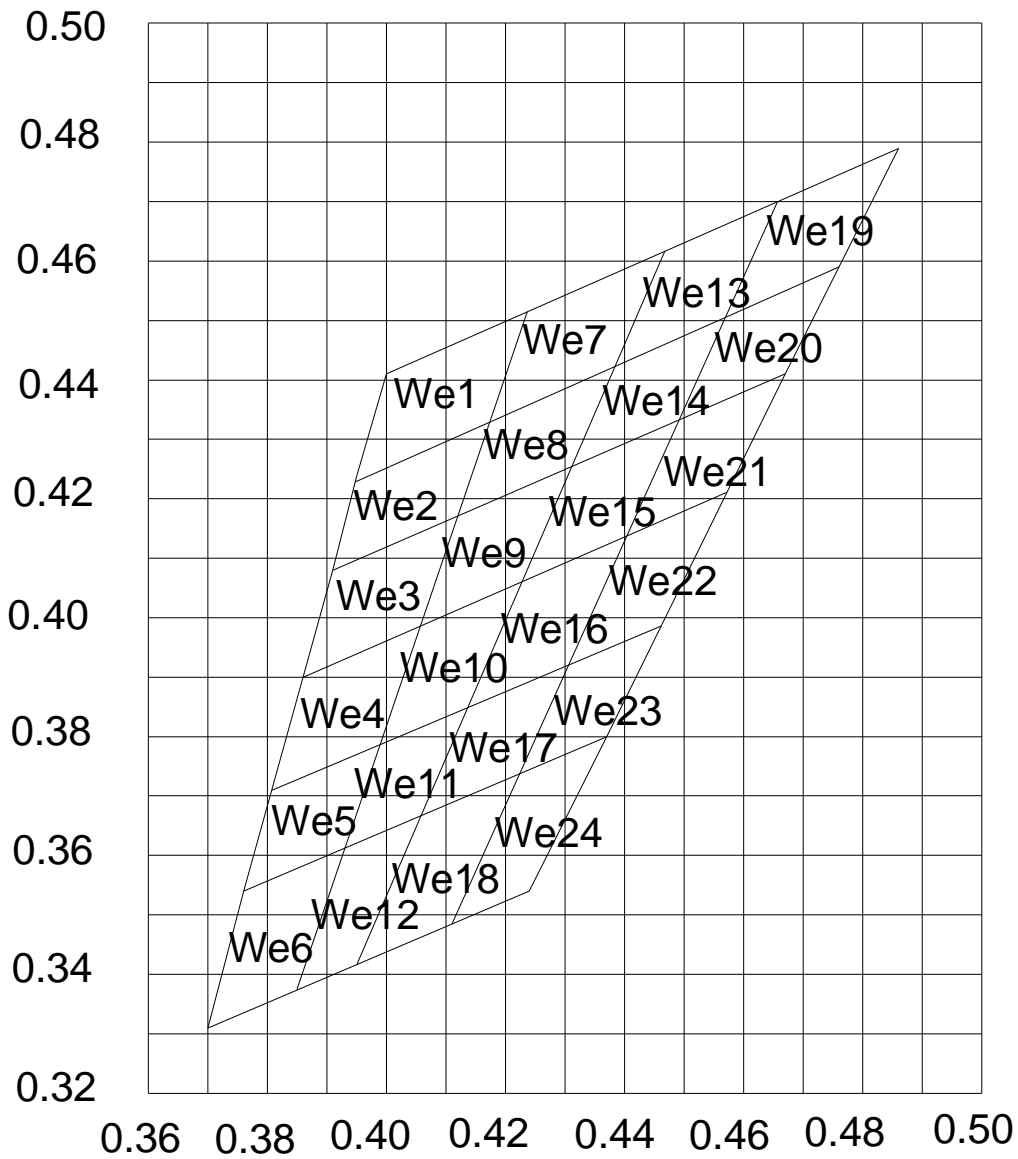
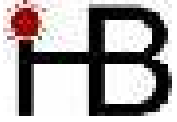

7、Typical electrical/optical characteristic curves/光电特性曲线:

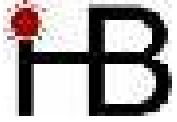

Part No./型号: PLCC6W3

Fig.1 正向电流 Vs. 正向电压

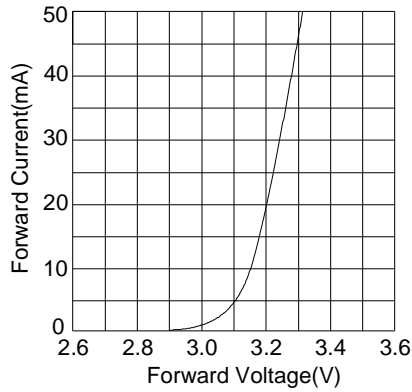

Fig.2 相对亮度 Vs. 正向电流

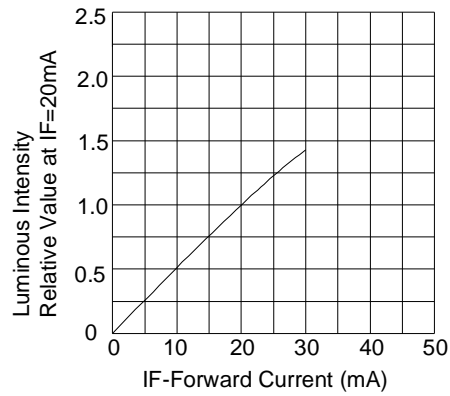

Fig.3 正向电流 Vs. 环境温度

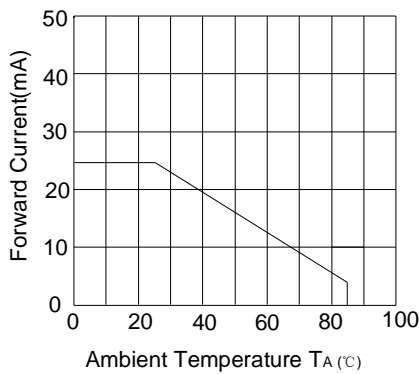
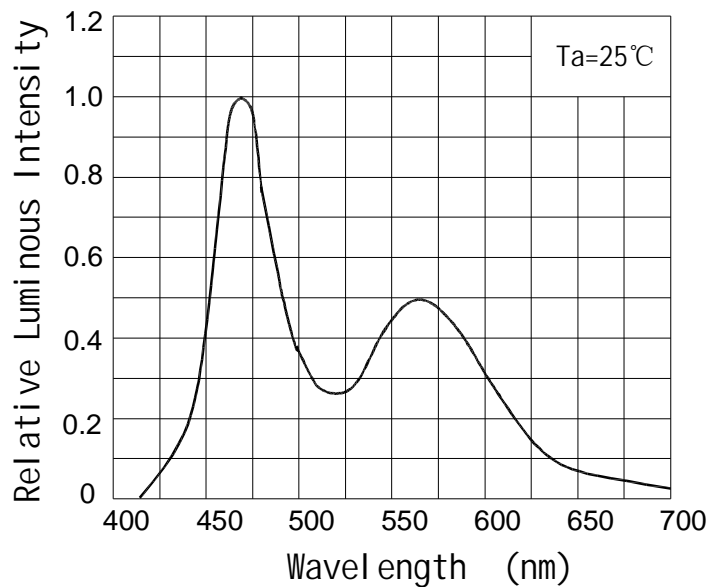
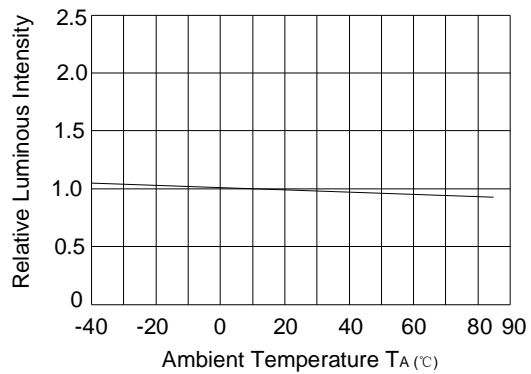
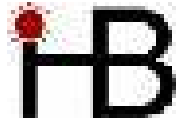

Fig.4 相对亮度 Vs. 环境温度



8、Reliability Analysis/可靠性试验



Part No./型号: PLCC6W3

8.1 Test Items And Results/测试项目和判据

No.	Item/项目	Test Condition/测试条件	Spec. / 引用标准	Q'ty/ 数量	Time/ 时间	Standard/判定
1	IR Reflow (Reflow Soldering) /回流焊接	Tsld=260°C, 10sec	GB/T 4937, II, 2.2	20	2times	ALL PASS
2	Solder ability/可焊性	Tsld=235±5°C, 3sec		20	1times Over 95%	ALL PASS
3	Temperature Cycle/ 高低温循环	-40°C—— 100°C 30min ~ 30min The cut is not more than 1 min	GB/T 4937, III, 1	20	50cycles	ALL PASS
4	Moisture Resistance Cyclic /湿热循环	25°C/12hr~ 55°C/12hr 95%RH	GB/T 4937, III, 4	20	6cycles	ALL PASS
5	High Temperature Storage /高温储存	Ta=100°C	GB/T 4937, III, 2	20	1000hrs	ALL PASS
6	Low Temperature Storage /低温储存	Ta=-40°C	GB/T 4937, III, 2	20	1000hrs	ALL PASS
7	Steady State perating Life /电耐久性	IF=20mA Ta=25°C	GB/T 18904.3 Part A	20	1000hrs	Iv decay <30%

8.2 Criteria For Judging Damage/判断标准

Item/项目	Symbol/ 符号	Test conditions /测试条件	Criteria for Judgement /判断标准	
			Min./最小值	Max./最大值
Luminous Intensity/亮度	Iv	IF=20mA	Iv*0.7	/
Forward Voltage/正向电压	VF	IF=20mA	/	U.S.L*1.1
Reverse current/反向电流	IR	VR=5v	/	U.S.L*2

*U.S.L.: Upper Standard Level / 上限

*L.S.L.: Lower Standard Level / 下限

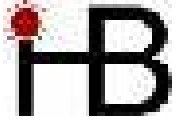

9、 Specification of Packing /包装规格

9.1 Taping and Orientation/编带和方向

Quantity/数量: 1000 units/reel

Diameter/直径: 178 mm

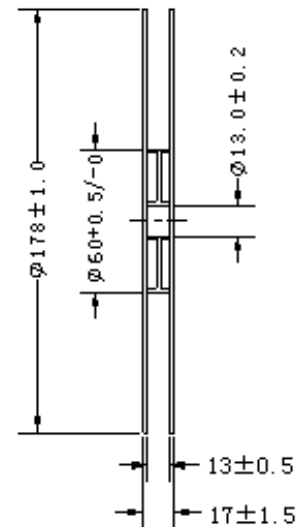
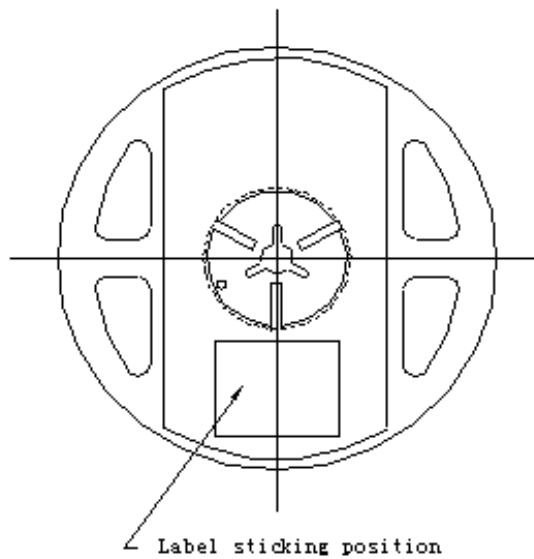
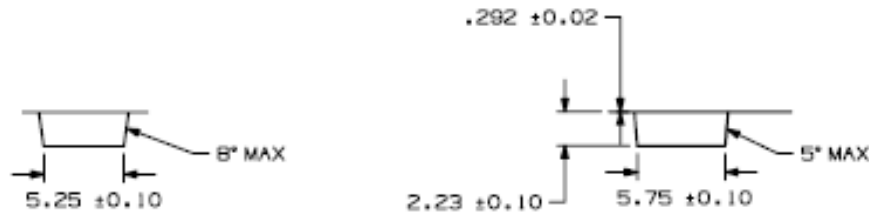
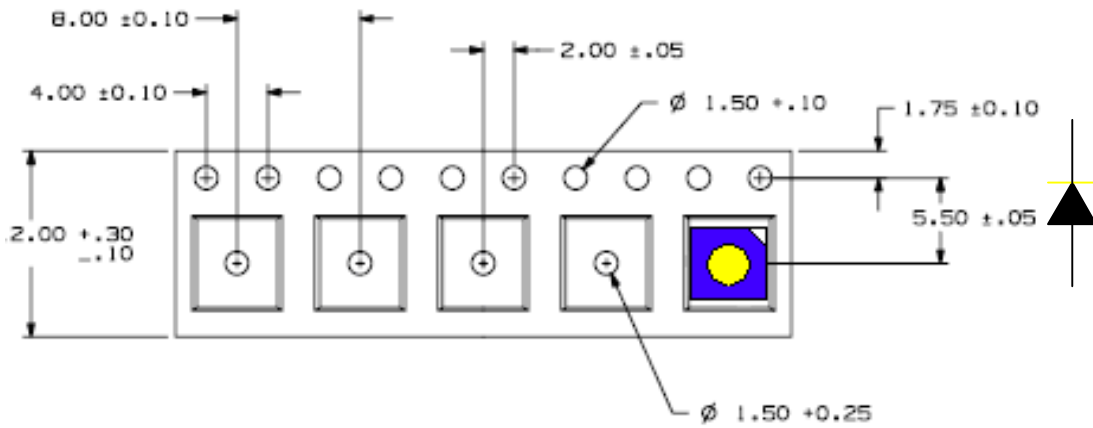

9.2 Specification of Packing/包装规格

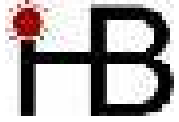

Diameter/直径 : 178 mm

Width/宽度 : 17 mm

=>1000 pcs / Reel

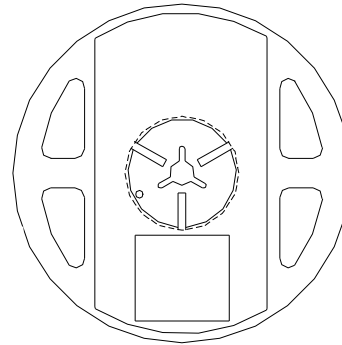

(Anti-Static Shielding/抗静电保护袋)

Thickness/厚度: T=0.1 mm

=> 1 Reel / Bag

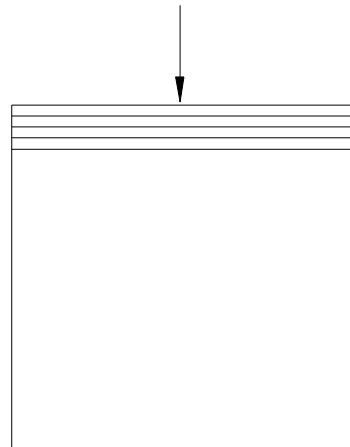

4 Bags / Box

=>4,000 pcs / Box

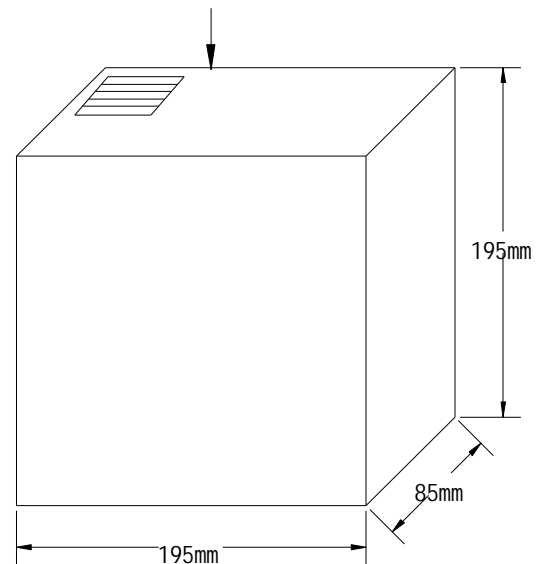

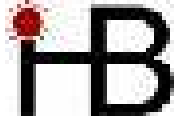

10、Notes/注意

10.1 Moisture Proof Packaging/防潮包装

10.1.1 LEDs need to package in moisture proof bag. When moisture is absorbed into the SMT package it may vaporize and expand during soldering. There is a possibility that this can cause exfoliation of the contacts and damage to the optical characteristics of the LEDs. For this reason, the moisture proof bag is used to keep moisture to a minimum in the bag.

产品必须包封装在防潮包装袋中。当湿气进入防潮包装袋的时候，在焊接时，湿气会受热汽化膨胀，从而可能影响产品的光学特性，甚至造成封装胶体的开裂剥离。因此，防潮袋要求放置在保持低湿度的盒中。

10.1.2 Moisture proof function is inactive. The moisture proof bag is made of an aluminum moisture proof bag. A package of a moisture absorbent material (silica gel) is inserted into the aluminum moisture proof bag. The silica gel turns the smashing from the transparent circular spherical pellet.

防潮的作用是缓慢的。防潮袋使用铝防潮袋，并在铝防潮袋中放入潮气吸收材料（硅胶干燥剂）。当硅胶干燥剂吸收潮气后，硅胶干燥剂从透明圆形球状颗粒变成粉碎物。

10.2 Storage Method/储存方式

10.2.1 Before opening the bag: The LEDs should be used within a year and kept at 30°C or less and 70%RH or less. The moisture proof bag with absorbent material is needed when storing the LEDs.

拆开包装袋之前：产品可以使用一年，但要求放置在温度低于30°C,湿度低于70%的环境中；当存放产品时，必须放置在带有干燥剂的防潮容器中。

10.2.2 After opening the bag: The LEDs should be soldered within 72 hours after opening the package. If unused LEDs remain, they should be stored in moisture proof bags with moisture absorbent material. If the LEDs have exceeded the storage time or the moisture absorbent material has faded away. Baking process should be performed by using more than 24hours baking at 60±5°C before using LEDs. It recommended that the user use the LEDs as soon as possible.

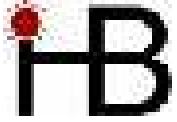

Part No./型号: PLCC6W3

拆开包装袋之后：产品应该在拆封后的72小时内焊接完毕；如果没用完，产品应该储存在带有干燥剂的防潮包装袋中；如果产品超出了使用期限或者干燥剂失效，那么产品在使用前必须在 $60 \pm 5^\circ\text{C}$ 中烘烤至少24小时；建议客户尽快的使用完产品。

10.3 Heat Generation/产品热量的产生

Thermal design of the end applications are of paramount importance. Please consider the heat generation of the LED when making the system design. It is necessary to avoid intense heat generation and operate within the maximum ratings given in this specification.

应用产品的热学设计是至关重要的。在做系统设计时，请考虑LED的散热，避免热量的积累，必须严格的在允许的温度范围内使用。

10.4 Soldering/焊接

10.4.1 Lead Solder/回流焊接

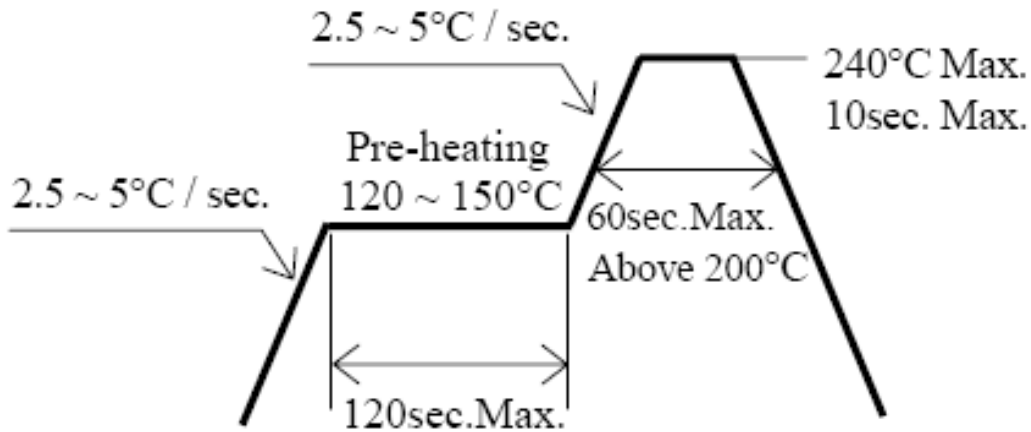

10.4.2 Lead – Free Solder/无铅回流焊接

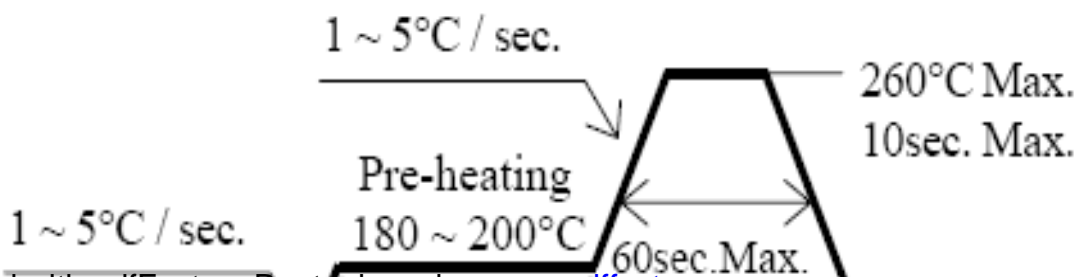

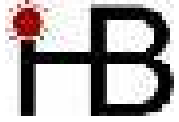

10.4.3 Hand Soldering (Not Recommended) /手工焊接 (不推荐)

Soldering iron/烙铁焊接: 300 degrees C max/不超过300℃; 5 seconds max/不超过5s; once/允许1次.

10.5 Cleaning/清洗

It is recommended that isopropyl alcohol be used as a solvent for cleaning the LEDs. It should be confirmed beforehand whether the solvents will dissolve the package the resin or not when using other solvents. Please do not clean the LEDs by the ultrasonic. If it is absolutely necessary, the influence of ultrasonic cleaning on the LEDs depends on ultrasonic power and the assembled condition. Before cleaning, a pre-test should be done to confirm whether any damage to the LEDs will occur.

建议使用酒精作为溶剂清洗LEDs。若要使用其他溶剂，应该预先证实是否能溶化封装料。请不要使用超声波清洗LEDs，如果一定要使用超声波清洗，则一定要注意超声波的功率和超声条件。在清洗作业前，必须预先实验确认对LEDs无任何的伤害。

10.6 Static Electricity/静电

It is recommended that a wrist band or an anti-electrostatic glove be used when handling the LEDs. All devices, equipment and machinery must be properly grounded. It is recommended that precautions be taken against surge voltage to the equipment that mounts the LEDs.

在接触LEDs时，建议使用防静电手腕带或防静电手套。所有的器件、设备和机器必须有可靠的接地。对所有LEDs接触的设备，建议采取预防措施消除冲击电压。

10.7 Others/其他

The LED light output is strong enough to injure human eyes. Precautions must be taken to

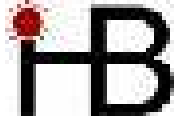

Part No./型号: PLCC6W3

prevent looking directly at the LEDs with unaided eyes for more than a few seconds.

LED的光辐射足够强时，会对人眼造成伤害。若眼睛要直接看LED，并且要一定的时间，则必须采取相应防护措施。