

Version :3.0

<p style="text-align: center;">TECHNICAL SPECIFICATION</p> <p style="text-align: center;">MODEL NO. : PM070WT4</p>
--

The content of this information is subject to be changed without notice.
Please contact PVI or its agent for further information.

Customer's Confirmation

Customer _____

Date _____

By _____

PVI's Confirmation

Confirmed By _____

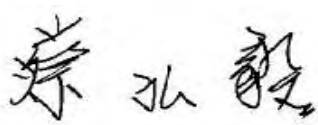
Prepared By _____

TECHNICAL SPECIFICATION

CONTENTS

NO.	ITEM	PAGE
-	Cover	1
-	Contents	2
1	Application	3
2	Features	3
3	Mechanical Specifications	3
4	Mechanical Drawing of TFT-LCD module	4
5	Input / Output Terminals	6
6	Touch Panel Characteristics	8
7	Absolute Maximum Ratings	9
8	Electrical Characteristics	9
9	Pixel Arrangement	11
10	Display Color and Gray Scale Reference	12
11	Block Diagram	13
12	Interface Timing	14
13	Power On Sequence	17
14	Optical Characteristics	17
15	Handling Cautions	21
16	Reliability Test	22
17	Packing Diagram	23
-	Revision History	24

1.Application

This data sheet applies to a color TFT LCD module, PM070WT4. The application of panel are OA product, portable DVD, car TV(must use Analog to Digital driving board), which requires high quality flat panel display.

Prime View assume no responsibility for any damage resulting from the use of the device which dose not comply with the instructions and the precautions in these specification sheet.

2. Features

- . Wide VGA (800*480 pixels) resolution
- . Amorphous silicon TFT LCD panel with back-light unit
- . Pixel in stripe configuration
- . Thin and light weight
- . Display Colors : 262,144 colors
- . +3.3V DC supply voltage for TFT LCD panel driving
- . Wide viewing angle
- . TTL interface
- . Module with resistive type touch panel .
- . Backlight driving DC/AC inverter not included in this module

3.Mechanical Specifications

Parameter	Specifications	Unit
Screen Size	7.0(diagonal)	inch
Display Format	800×(R, G, B)×480	dot
Display Colors	262,144	
Active Area	152.4(H)×91.44(V)	mm
Pixel Pitch	0.1905(H)×0.1905(V)	mm
Pixel Configuration	Stripe	
Outline Dimension	166.3(W)×105.3 (H)×10.7 (typ.) (D)	mm
Weight	318±15	g
Back-light	CCFL, 1 tube	
Surface treatment	Anti-glare and Wide View Film	
Display mode	Normally white	
Surface treatment of Touch Panel	3H	
Gray scale inversion direction	6 o'clock [ref to Page 17 viewing angle]	

4.Mechanical Drawing of TFT-LCD Module
Outline Drawing : Front View (unit mm)

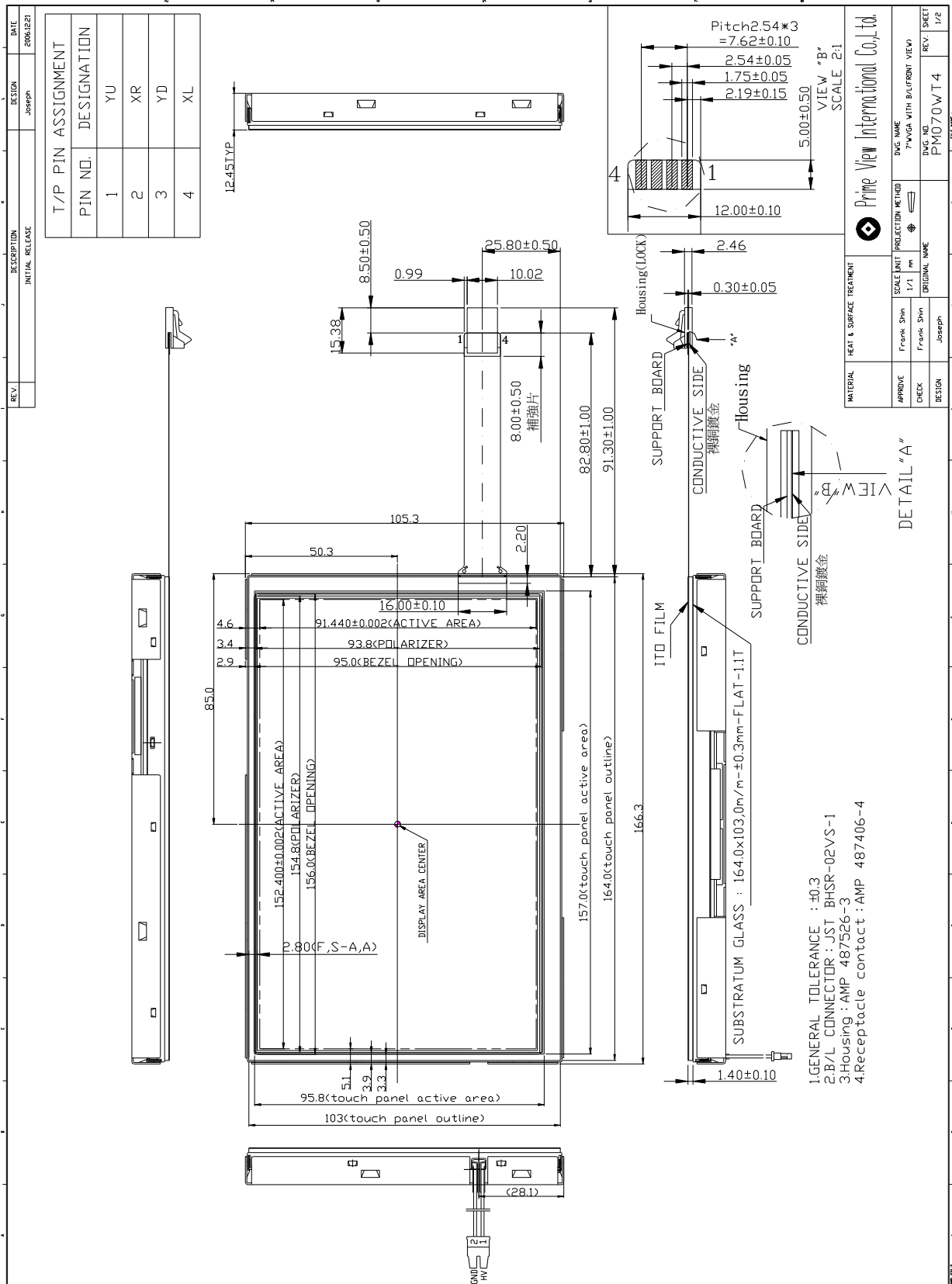

Outline Drawing : Rear View (unit mm)

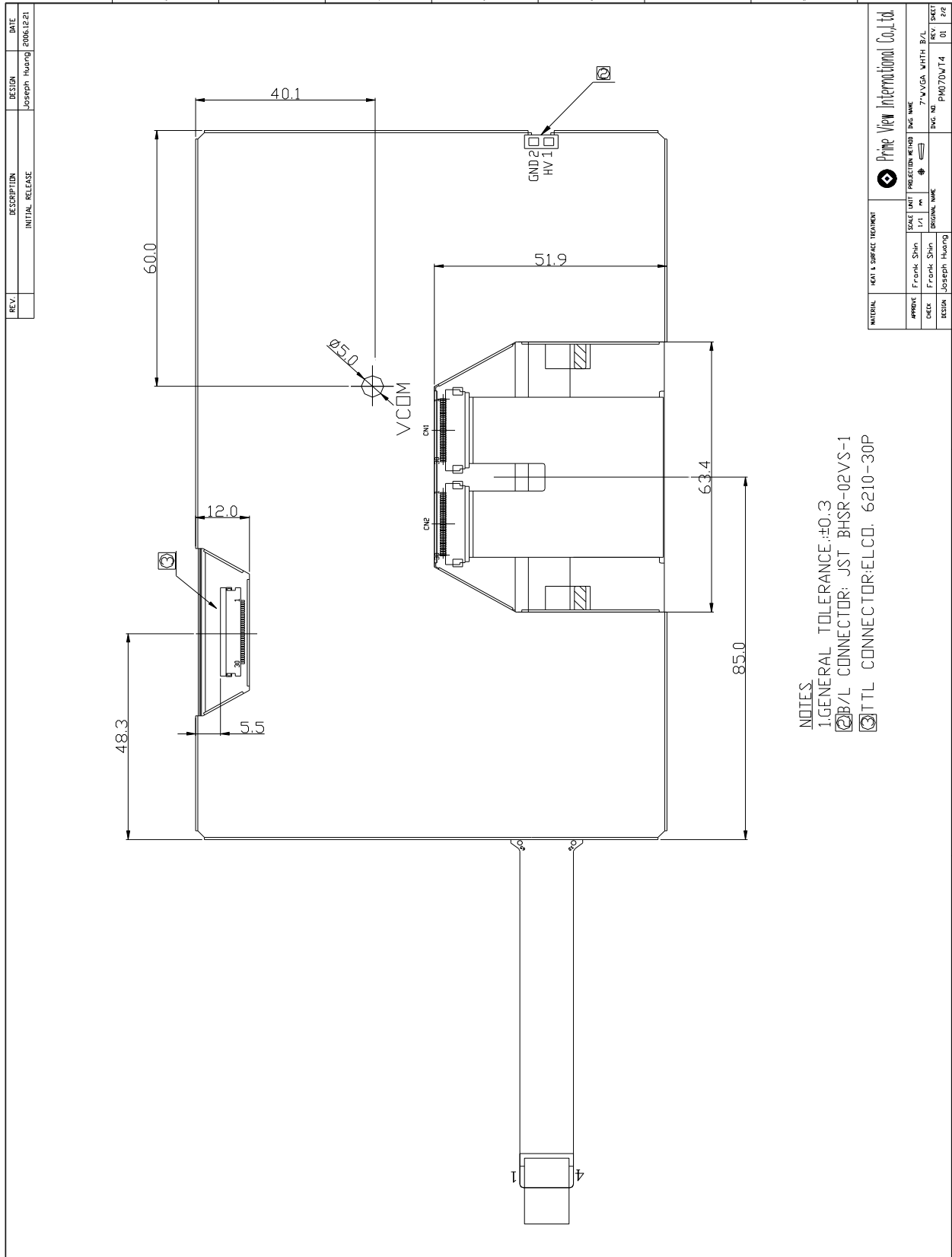

NOTES.
 1.GENERAL TOLERANCE:±0.3
 2.B/L CONNECTOR: JST BHSR-02VS-1
 3.ITTL CONNECTOR:ELCO. 6210-30P

REV.	DESCRIPTION	DESIGN	DATE
	INITIAL RELEASE	Joseph Huang	2006.02.21

APPROV	FRANK SHIN	SCALE	1:1	PROJ CODE	PM070WT4	DWG NAME	7" W/GGA, WHITE, B/L	
DESIGN	JOSEPH HUANG	DATE	01.01.06	DESIGNER	JOSEPH HUANG	DWG NO.	PM070WT4	
							REV	01
							SHEET	2/2

5. Input Terminals

5-1) TFT-LCD Panel Driving

Connector type: ELCO 6210-30P

Pin No.	Symbol	Function	Remark
1	CLK	Clock Signal for Sampling Image Digital Data	
2	Hsync	Horizontal Synchronous Signal	
3	Vsync	Vertical Synchronous Signal	
4	GND	Ground (0V)	
5	R0	Red Image Data Signal (LSB)	
6	R1	Red Image Data Signal	
7	R2	Red Image Data Signal	
8	R3	Red Image Data Signal	
9	R4	Red Image Data Signal	
10	R5	Red Image Data Signal (MSB)	
11	GND	Ground (0V)	
12	G0	Green Image Data Signal (LSB)	
13	G1	Green Image Data Signal	
14	G2	Green Image Data Signal	
15	G3	Green Image Data Signal	
16	G4	Green Image Data Signal	
17	G5	Green Image Data Signal (MSB)	
18	GND	Ground (0V)	
19	B0	Blue Image Data Signal (LSB)	
20	B1	Blue Image Data Signal	
21	B2	Blue Image Data Signal	
22	B3	Blue Image Data Signal	
23	B4	Blue Image Data Signal	
24	B5	Blue Image Data Signal (MSB)	
25	GND	Ground (0V)	
26	DENB	Compound Synchronization signal	Note5-1
27	VCC	DC +3.3V Power Supply	
28	VCC	DC +3.3V Power Supply	
29	R/L	Left / Right control for source driver	Note5-2
30	U/D	Up / Down control for gate driver	Note5-2

Note5-1 DENB input signal.

If customer wanted to off the DENB mode , you must keep the DENB always High or Low.

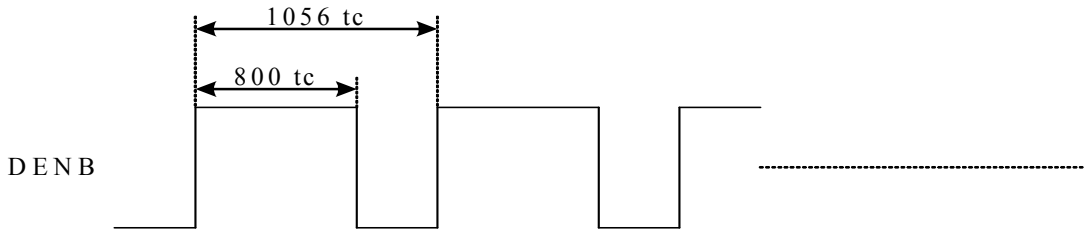

(tc: the period of sampling clock)

Note 5-2 The definitions of U/D & R/L

U/D(PIN 30)=Low R/L(PIN 29)=High

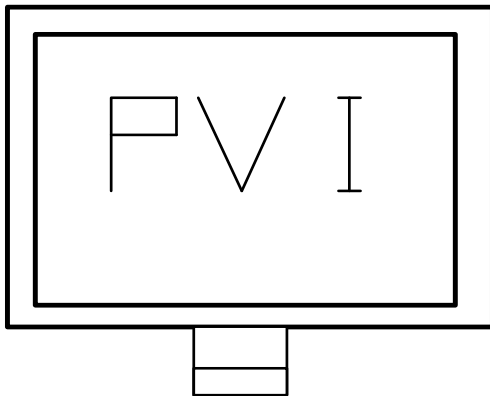

U/D(PIN 30)=High R/L(PIN 29)=Low

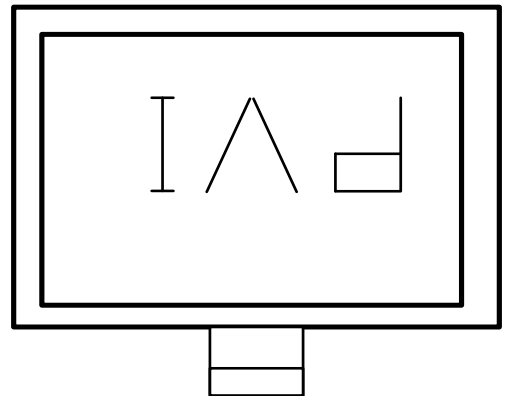

6.Touch Panel Characteristics

6.1) Pin assignment:

Pin	Symbol	Function	Remark
1	YU	Upper electrode Y(Upper side)	
2	XR	Lower electrode X(Right side)	
3	YD	Upper electrode Y(Down side)	
4	XL	Lower electrode X(Left side)	

6.2) Electrical Performance:

Parameters	Symbol	MIN.	Typ.	MAX.	Unit	Remark
Terminal Resistance	X	580	840	1200	Ω	
	Y	120	180	260	Ω	
Input Voltage	V _T	-	5.0	7.0	V	
Linearity(X ,Y direction)		-	-	± 1.5	%	
Insulation Impedance		20	-	-	M Ω	DC 25V
Response Time		-	-	15	ms	
Operation Force		-	-	50	g	Note 6-1

Note 6-1 Input through 0.8R stylus or finger.

6.3) Durability Performance

1. Hitting Durability:

At least 1,000,000 times with R8.0mm silicon rubber, 250g , 3times/sec .

2. Sliding Durability:

At least 100,000 times with R0.8mm polyacetal stylus , 250g , 60mm/sec.

7. Absolute Maximum Ratings:

GND=0V, Ta=25°C

Parameters	Symbol	MIN.	MAX.	Unit	Remark
Supply Voltage	V _{CC}	-0.3	+4.0	V	
Input Signals Voltage	V _{IN}	-0.3	V _{CC} +0.3	V	
Backlight Driving Frequency	F _L	0	100	KHz	

8. Electrical Characteristics

8-1) Recommended Operating Conditions:

GND = 0V , Ta = 25°C

Item	Symbol	Min.	Typ.	Max.	Unit	Remark
Supply Voltage	V _{CC}	3.0	3.3	3.6	V	
Current Dissipation	I _{CC}	-	178.3	194.5	mA	Note7-1
Digital input voltage	High Level	V _{IN}	0.7 V _{CC}	-	V _{CC}	
	Low Level	V _{IL}	-0.1	-	0.1V _{CC}	
V _{com} Voltage	V _{com}	-	3.1	-	V	

Note 8-1 : To test the current dissipation of VCC using the “color bars” testing pattern shown as below

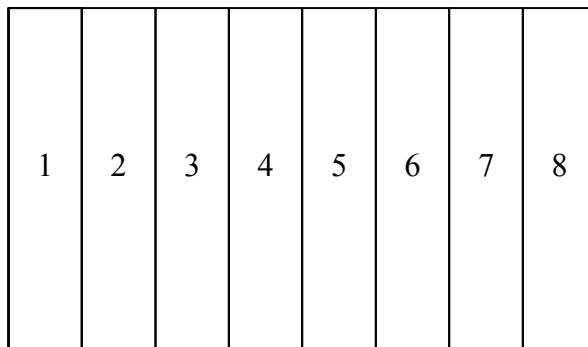

1. White
2. Yellow
3. Cyan
4. Green
5. Magenta
6. Red
7. Blue
8. Black

I_{CC} current dissipation testing pattern

8-2) Recommended Driving Condition for Back Light

Ta=25°C

Parameter	Symbol	Min.	Typ.	Max.	Unit	Remark
Lamp Voltage	V_L	522	580	638	V	$I_L=6mA$
Lamp Current	I_L	4	6	7	mA	Note 8-2
Lamp Frequency	P_L	45	60	80	KHz	Note 8-3
Starting Voltage (25°C) (Reference Value)	V_s	-	-	1090	Vrms	Note 8-4
Starting Voltage (0°C) (Reference Value)	V_s	-	-	1420	Vrms	Note 8-4

Note 8-2 In order to satisfy the quality of B/L, no matter use what kind of inverter, the output lamp current must between Min. and Max. to avoid the abnormal display image caused by B/L.

Note 8-3: The waveform of lamp driving voltage should be as closed to a perfect sine wave as possible.

Note 8-4 The "Max of starting voltage" means the minimum voltage of inverter to turn on the CCFL. and it should be applied to the lamp for more than 1 second to start up. Otherwise the lamp may not be turned on.

8-3) Backlight driving & Power Consumption

Pin No	Symbol	Description	Remark
1	VL1	Input terminal (Hi voltage side)	
2	VL2	Input terminal (Low voltage side)	Note 8-6

Note 8-6 : Low voltage side of backlight inverter connects with ground of inverter circuits.

Parameter	Symbol	Typ.	Max.	Unit	Remark
LCD Power consumption (W/O BL)	-	0.59	0.71	W	
Backlight Lamp Power Consumption	-	3.48	4.47	W	Note 8-7
Total Power Consumption	-	4.07	5.18	W	

Note 8-7: Backlight lamp power consumption is calculated by $I_L \times V_L$

9. Pixel Arrangement

The LCD module pixel arrangement is the stripe.

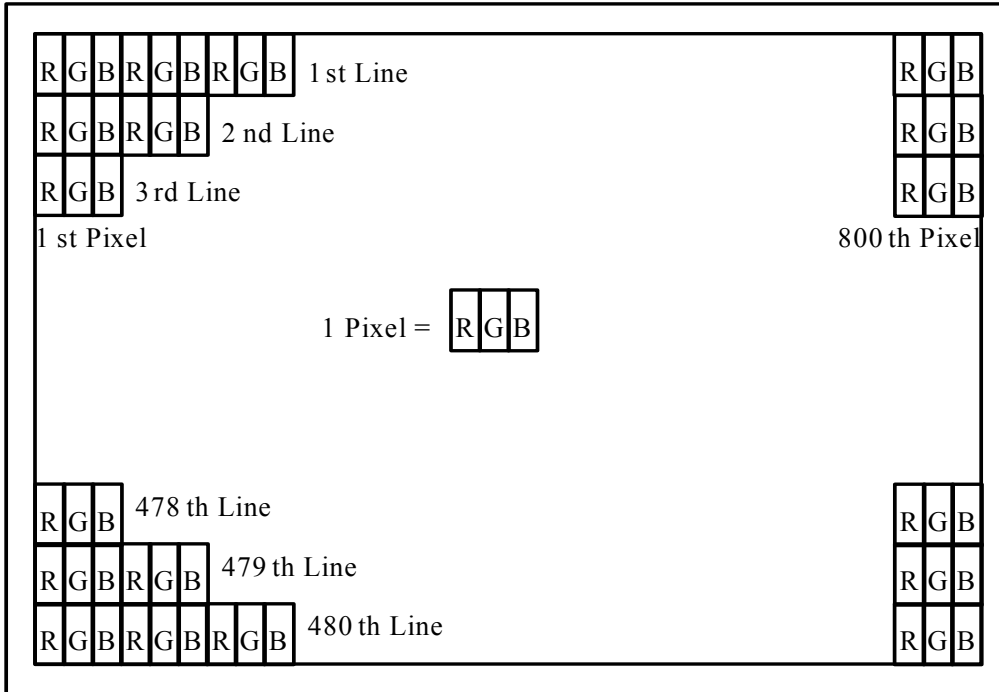

10. Display Color and Gray Scale Reference

Color		Input Color Data																	
		Red						Green						Blue					
		R5	R4	R3	R2	R1	R0	G5	G4	G3	G2	G1	G0	B5	B4	B3	B2	B1	B0
Basic Colors	Black	0	0	0	0	0	0	0	0	0	0	0	0	0	0	0	0	0	0
	Red (63)	1	1	1	1	1	1	0	0	0	0	0	0	0	0	0	0	0	0
	Green (63)	0	0	0	0	0	0	1	1	1	1	1	1	0	0	0	0	0	0
	Blue (63)	0	0	0	0	0	0	0	0	0	0	0	0	1	1	1	1	1	1
	Cyan	0	0	0	0	0	0	1	1	1	1	1	1	1	1	1	1	1	1
	Magenta	1	1	1	1	1	1	0	0	0	0	0	0	1	1	1	1	1	1
	Yellow	1	1	1	1	1	1	1	1	1	1	1	1	0	0	0	0	0	0
	White	1	1	1	1	1	1	1	1	1	1	1	1	1	1	1	1	1	1
Red	Red (00)	0	0	0	0	0	0	0	0	0	0	0	0	0	0	0	0	0	0
	Red (01)	0	0	0	0	0	1	0	0	0	0	0	0	0	0	0	0	0	0
	Red (02)	0	0	0	0	1	0	0	0	0	0	0	0	0	0	0	0	0	0
	Darker																		
	↓	↓	↓	↓	↓	↓	↓	↓	↓	↓	↓	↓	↓	↓	↓	↓	↓	↓	↓
	Brighter																		
	Red (61)	1	1	1	1	0	1	0	0	0	0	0	0	0	0	0	0	0	0
	Red (62)	1	1	1	1	1	0	0	0	0	0	0	0	0	0	0	0	0	0
Red (63)	1	1	1	1	1	1	0	0	0	0	0	0	0	0	0	0	0	0	
Green	Green (00)	0	0	0	0	0	0	0	0	0	0	0	0	0	0	0	0	0	0
	Green (01)	0	0	0	0	0	0	0	0	0	0	0	1	0	0	0	0	0	0
	Green (02)	0	0	0	0	0	0	0	0	0	0	1	0	0	0	0	0	0	0
	Darker																		
	↓	↓	↓	↓	↓	↓	↓	↓	↓	↓	↓	↓	↓	↓	↓	↓	↓	↓	↓
	Brighter																		
	Green (61)	0	0	0	0	0	0	1	1	1	1	0	1	0	0	0	0	0	0
	Green (62)	0	0	0	0	0	0	1	1	1	1	1	0	0	0	0	0	0	0
Green (63)	0	0	0	0	0	0	1	1	1	1	1	1	0	0	0	0	0	0	
Blue	Blue (00)	0	0	0	0	0	0	0	0	0	0	0	0	0	0	0	0	0	0
	Blue (01)	0	0	0	0	0	0	0	0	0	0	0	0	0	0	0	0	0	1
	Blue (02)	0	0	0	0	0	0	0	0	0	0	0	0	0	0	0	0	1	0
	Darker																		
	↓	↓	↓	↓	↓	↓	↓	↓	↓	↓	↓	↓	↓	↓	↓	↓	↓	↓	↓
	Brighter																		
	Blue (61)	0	0	0	0	0	0	0	0	0	0	0	0	1	1	1	1	0	1
	Blue (62)	0	0	0	0	0	0	0	0	0	0	0	0	1	1	1	1	1	0
Blue (63)	0	0	0	0	0	0	0	0	0	0	0	0	1	1	1	1	1	1	

11. Block Diagram

11-1) TFT-module Block Diagram

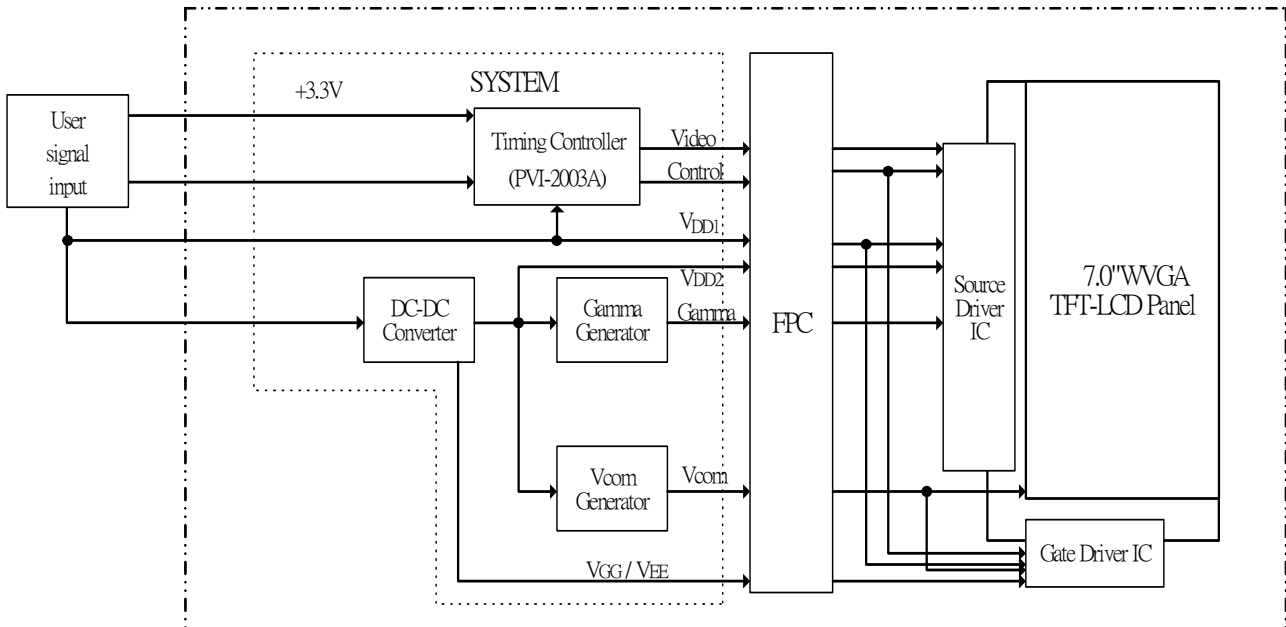

12. Interface Timing

12.1) Timing Parameters

		Symbol	Min.	Typ.	Max.	Unit	Remark	
Power supply		VCC	3.0	3.3	3.6	V		
CLK	Frequency	1/tc	-	32	-	MHz		
		tc	-	31.25	-	ns		
HSYNC	Period	Hp	-	33	-	us		
			-	1056	-	tc		
	Display period	Hdp	-	800	-	tc		
	Pulse width	Hpw	-	128	-	tc		
	Back-porch	Hbp	-	86	-	tc		
	Front-porch	Hfp	-	42	-	tc		
	Hpw+Hbp			-	214	-	tc	
	Hsync-CLK	Hhc	10	-	Tc-10	ns		
	Vsync-Hsync	Hvh	0	0	200	tc		
VSYNC	Period	Vp	-	17.325	-	ms		
			-	525	-	Hp		
	Display period	Vdp	-	480	-	Hp		
	Pulse width	Vpw	-	2	-	Hp		
	Back-porch	Vbp	-	33	-	Hp		
	Front-porch	Vfp	-	10	-	Hp		
	Vpw+Vbp			-	35	-	Hp	
DENB	Horizontal scanning period	T1	860	1056	1064	tc		
	Horizontal display period	T2	-	800	-	tc		
	Vertical display period	T3	-	480	-	T1		
	Frame cycling period	T4	520	525	800	T1		
R,G,B	CLK-DATA	Dcd	10	-	-	ns		
	DATA-CLK	Ddc	8	-	-	ns		

12.2) The Timing Diagram

A. The timing chart for DENB mode

a-1 CLK data ,relationship

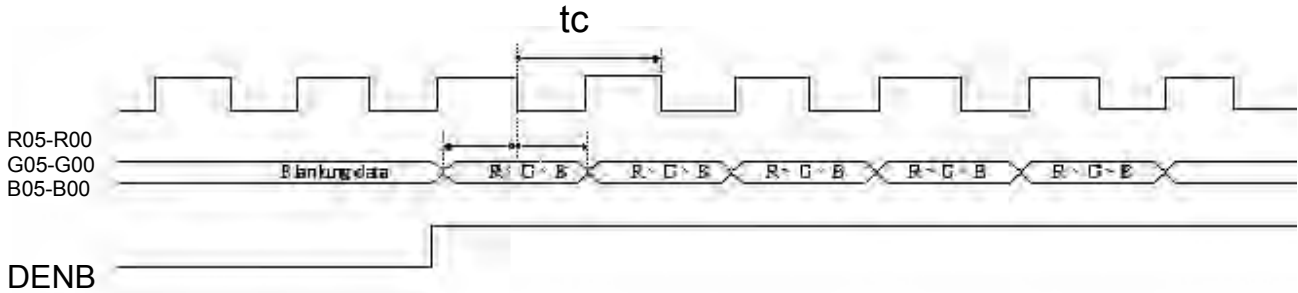

a-2 DENB Timing

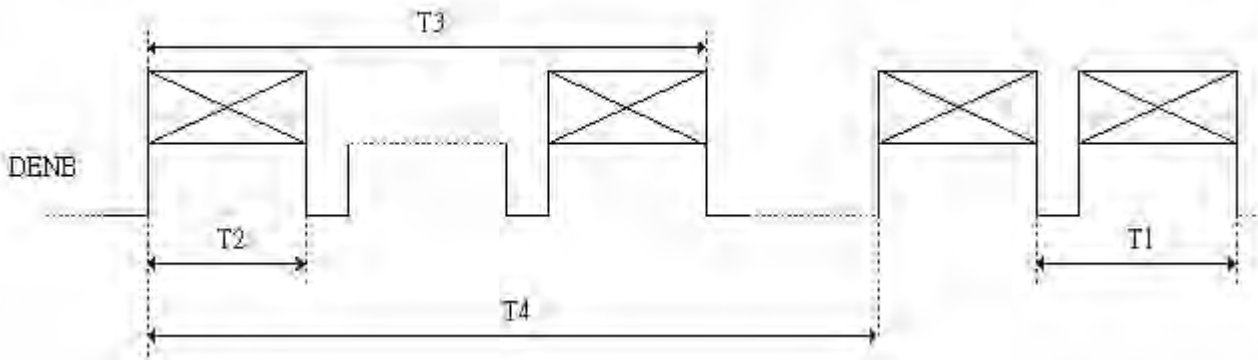

B. The timing chart for sync mode

b-1 CLK Hsync relation ship

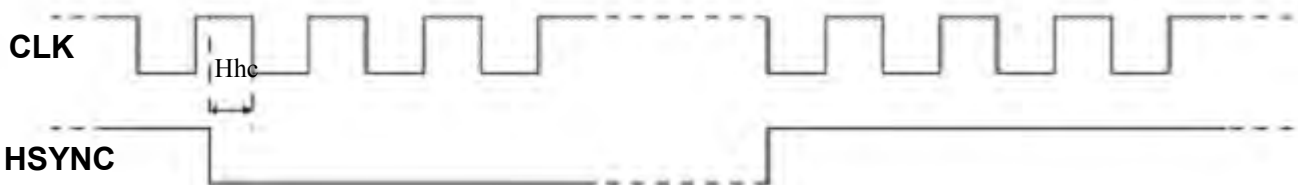

b-2 Hsync timing

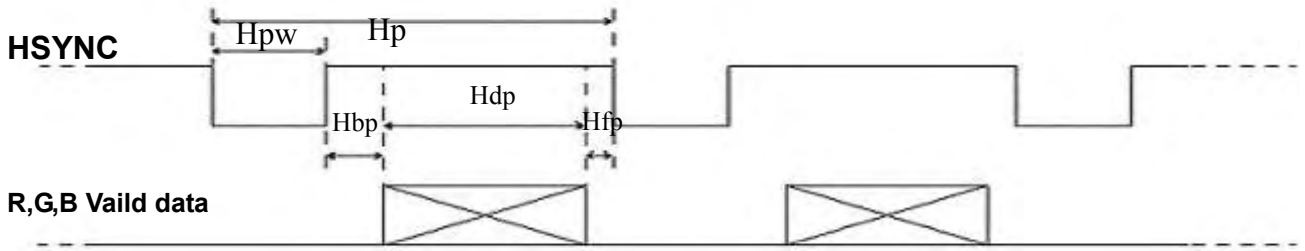

b-3 Hsync ,Vsync relation ship

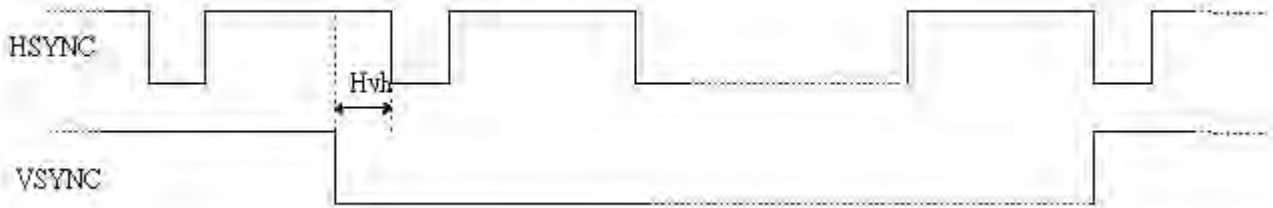

b-4 Vsync Timing

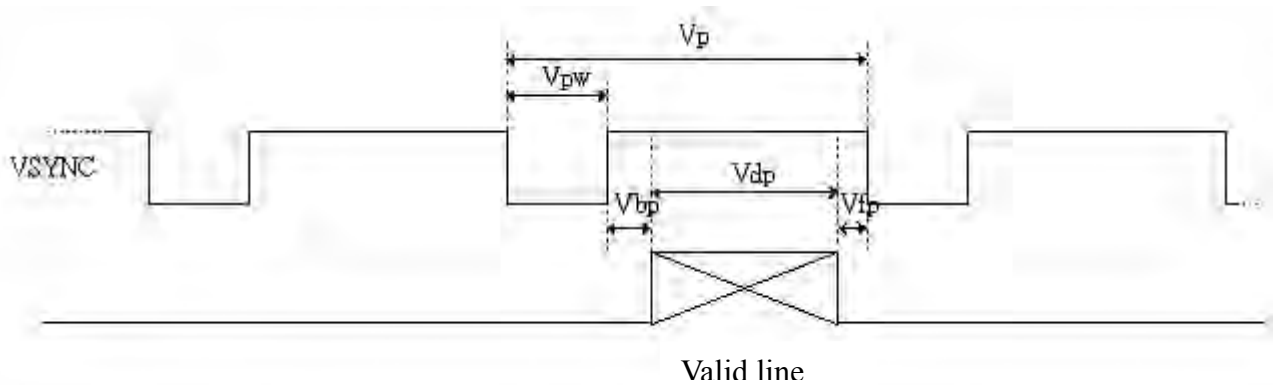

13. Power On Sequence

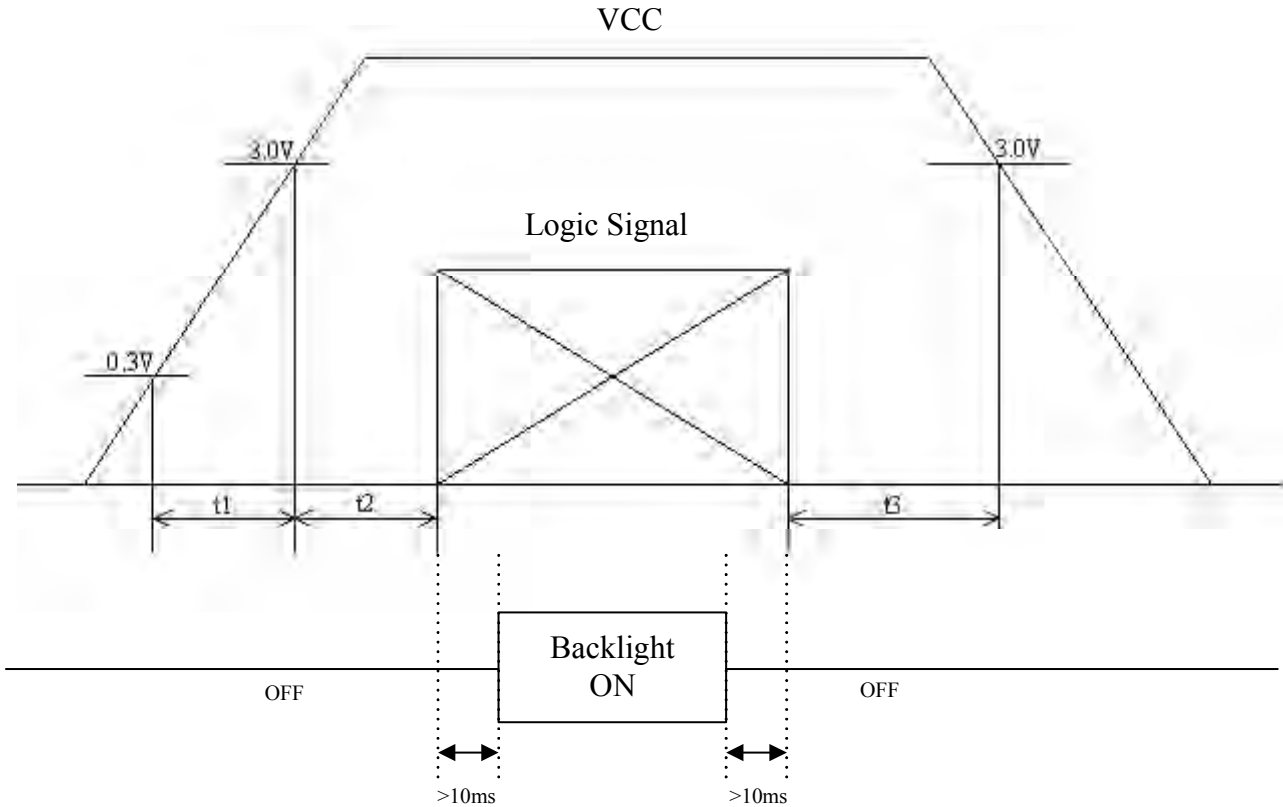

1. $0 < t1 \leq 20\text{ms}$
2. $0 < t2 \leq 50\text{ms}$
3. $0 < t3 \leq 1\text{s}$

14. Optical Characteristics

14-1) Specification:

Ta=25°C

Parameter	Symbol	Condition	MIN.	TYP.	MAX.	Unit	Remarks
Viewing Angle	Horizontal	θ 21.22	± 55	± 60	-	deg	Note 14-1
	Vertical	θ 12 (to 12 'clock)	35	40	-	deg	
		θ 11 (to 6 o'clock)	50	55	-	deg	
Contrast Ratio	CR	$\theta = 0^\circ / \varphi = 0$	250	400	-	-	Note 14-2
Response time	Rise	Tr	-	15	30	ms	Note 14-3
	Fall	Tf	-	25	50	ms	
Brightness	L	$\theta = 0^\circ / \varphi = 0$	280	330	-	cd/m ²	
Luminance Uniformity	U	-	70	75	-	%	Note 14-4
Lamp Life Time	-	-	25000	-	-	hr	At 6mA
White Chromaticity	x	$\theta = 0^\circ / \varphi = 0$	0.27	0.30	0.33	-	
	y		0.29	0.32	0.35	-	
Cross Talk	-	$\theta = 0^\circ$	-	-	3.5	%	Note 14-5

All the optical measurement shall be executed 30 minutes after backlight being turn-on. The optical characteristics shall be measured in dark room (ambient illumination on panel surface less than 1 Lux). The measuring configuration shows as following figure.

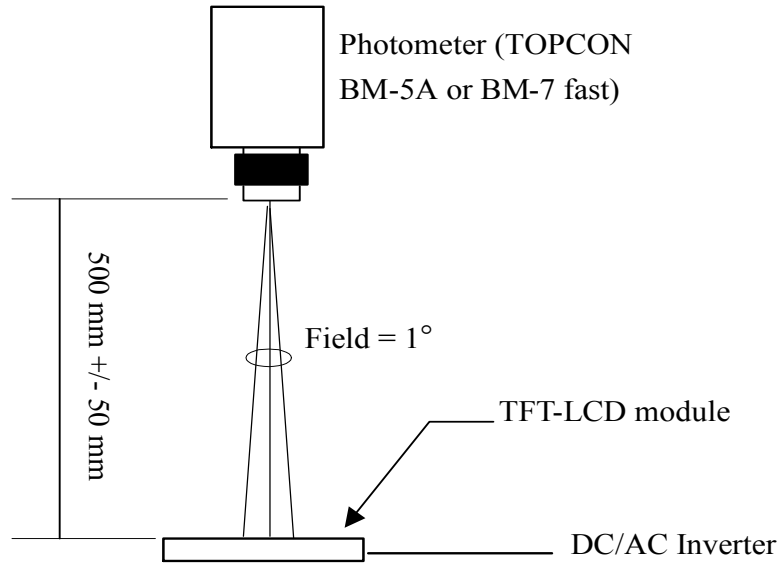

Optical characteristics measuring configuration

Topcon BM-5A or BM-7 fast luminance meter 1° field of view is used in the testing (after 30 minutes' operation). The typical luminance value is measured at lamp current 6.0 mA.

Note 14-1: The definitions of viewing angles are as follow.

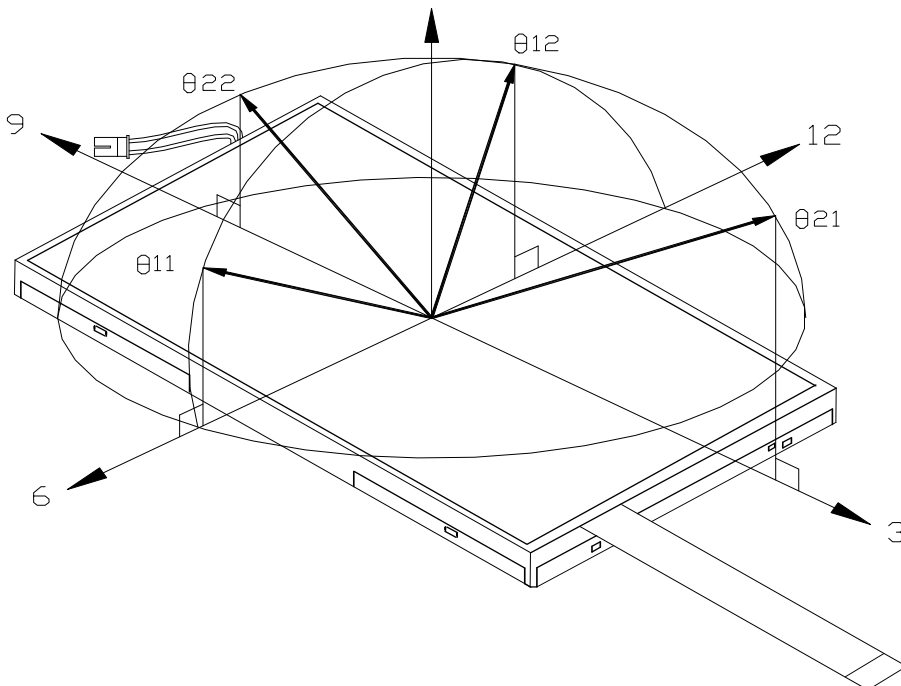

Note 14-2: The definition of contrast ratio $CR = \frac{\text{Luminance at gray level 63}}{\text{Luminance at gray level 0}}$

Note 14-3: Definition of Response Time T_r and T_f :

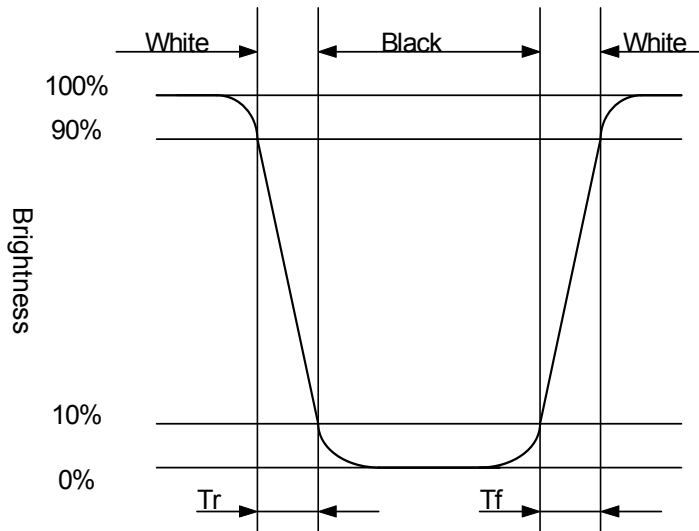

Note 14-4: The uniformity of LCD is defined as

$$U = \frac{\text{The Minimum Brightness of the 9 testing Points}}{\text{The Maximum Brightness of the 9 testing Points}}$$

Luminance meter : BM-5A or BM-7 fast(TOPCON)

Measurement distance : 500 mm +/- 50 mm

Ambient illumination : < 1 Lux

Measuring direction : Perpendicular to the surface of module

The test pattern is white (Gray Level 63).

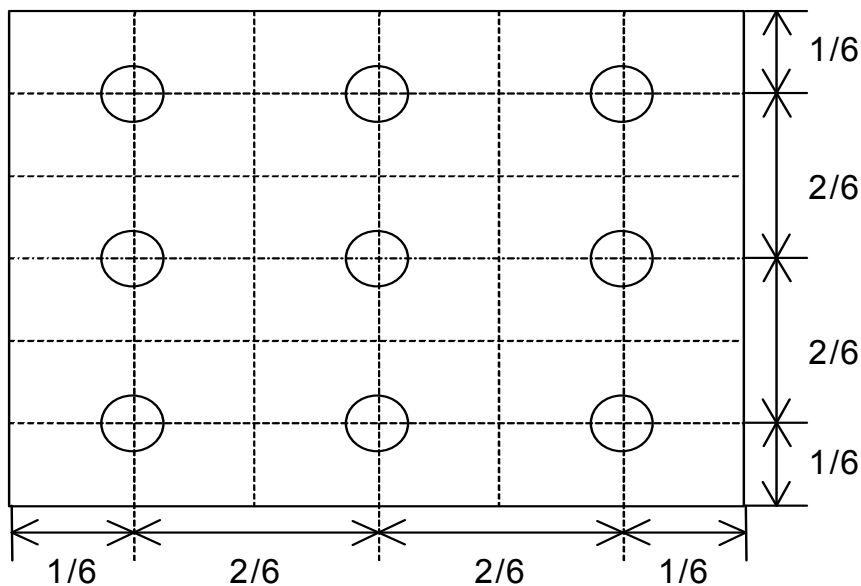

Note 14-5: Cross Talk (CTK) = $\frac{|Y_A - Y_B|}{Y_A} \times 100\%$

- YA: Brightness of Pattern A
- YB: Brightness of Pattern B
- Luminance meter : BM 5A or BM-7 fast (TOPCON)
- Measurement distance : 500 mm +/- 50 mm
- Ambient illumination : < 1 Lux
- Measuring direction : Perpendicular to the surface of module

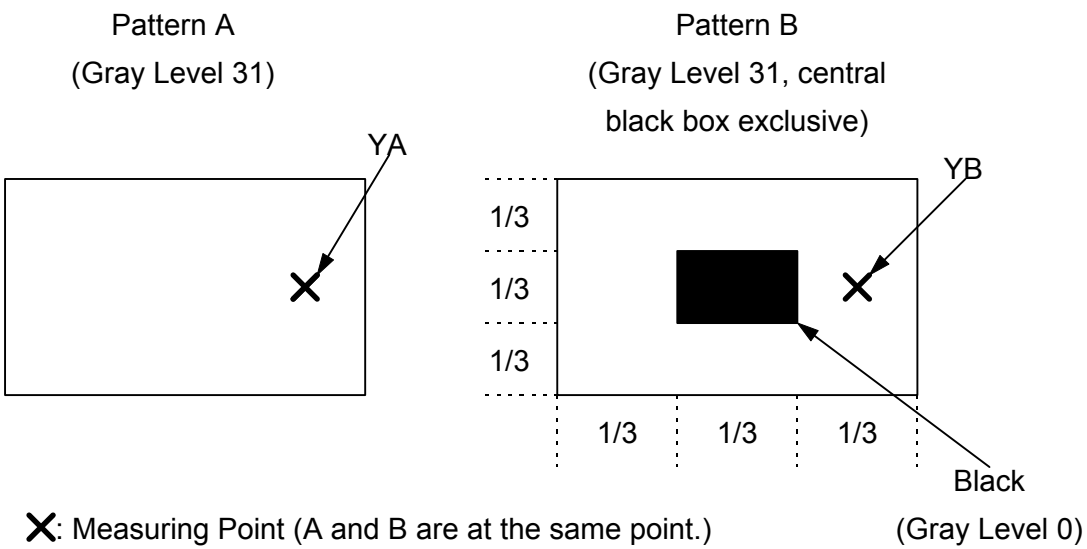

15. Handling Cautions

15-1) Mounting of module

- a) Please power off the module when you connect the input/output connector.
- b) Please connect the ground pattern of the inverter circuit surely. If the connection is not perfect, some following problems may happen possibly.
 - 1.The noise from the backlight unit will increase.
 - 2.The output from inverter circuit will be unstable.
 - 3.In some cases a part of module will heat.
- c) Polarizer which is made of soft material and susceptible to flaw must be handled carefully.
- d) Protective film (Laminator) is applied on surface to protect it against scratches and dirt. It is recommended to peel off the laminator before use and taking care of static electricity.

15-2) Precautions in mounting

- a) When metal part of the TFT-LCD module (shielding lid and rear case) is soiled, wipe it with soft dry cloth.
- b) Wipe off water drops or finger grease immediately. Long contact with water may cause discoloration or spots.
- c) TFT-LCD module uses glass which breaks or cracks easily if dropped or bumped on hard surface. Please handle with care.
- d) Since CMOS LSI is used in the module. So take care of static electricity and earth yourself when handling.

15-3) Adjusting module

- a) Adjusting volumes on the rear face of the module have been set optimally before shipment.
- b) Therefore, do not change any adjusted values. If adjusted values are changed, the specifications described may not be satisfied.

15-4) Others

- a) Do not expose the module to direct sunlight or intensive ultraviolet rays for many hours.
- b) Store the module at a room temperature place.
- c) The voltage of beginning electric discharge may over the normal voltage because of leakage current from approach conductor by to draw lump read lead line around.
- d) If LCD panel breaks, it is possibly that the liquid crystal escapes from the panel. Avoid putting it into eyes or mouth. When liquid crystal sticks on hands, clothes or feet. Wash it out immediately with soap.
- e) Observe all other precautionary requirements in handling general electronic components.
- f) Please adjust the voltage of common electrode as material of attachment by 1 module.

16. Reliability Test

No	Test Item	Test Condition	Remark
1	High Temperature Storage Test	Ta = +80°C, 240 hrs	
2	Low Temperature Storage Test	Ta = -30°C, 240 hrs	
3	High Temperature Operation Test	Ta = +70°C, 240 hrs	
4	Low Temperature Operation Test	Ta = -20°C, 240 hrs	
5	High Temperature & High Humidity Operation Test	Ta = +60°C, 90%RH, 240 hrs (No Condensation)	
6	Thermal Cycling Test (non-operating)	-30°C → +80°C, 100 Cycles 30min 30min	
7	Vibration Test (non-operating)	Frequency : 10 ~ 55 Hz, Amplitude : 1 mm Sweep time: 11 min Test Period: 6 Cycles for each direction of X, Y, Z	
8	Shock Test (non-operating)	100G, 6ms Direction: ±X, ±Y, ±Z Cycle: 3 times	
9	Electrostatic Discharge Test (non-operating)	Contact mode: ±8KV, 10times/point , 9 points/panel face Air mode: 150pF, 330Ω Air : ±15KV	
10	Hitting Durability Test (Touch panel)	1,000,000 times, with R 8.0 mm silicon rubber, 250g, 3times/sec	
11	Sliding Durability Test (Touch panel)	100,000 times, with R 0.8 mm polyacetal stylus, 250g, 60mm/sec	

Ta: ambient temperature

Note: The protective film must be removed before temperature test.

[Criteria]

In the standard conditions, there is not display function NG issue occurred. (including : line defect ,no image), All the cosmetic specification is judged before the reliability stress.

16. Packing Diagram

ZONE	REV.	DOCUMENT NO.	DESCRIPTION	DATE	REV. BY																																													
<p>NOTE:</p> <p>1. QTY: 40 pcs panel/carton. 2. Dimension: 530*295*230mm 3. Weight: 15.2 Kg</p>																																																		
		<table border="1" style="width:100%; border-collapse: collapse;"> <tr> <td style="width:5%;">4</td> <td style="width:15%;">50-0100111</td> <td style="width:60%;">CARTON</td> <td style="width:10%;">1</td> <td style="width:10%;"></td> </tr> <tr> <td>3</td> <td>50-0500071</td> <td>PINK Bag 190*190mm</td> <td>40</td> <td>抗靜電</td> </tr> <tr> <td>2</td> <td></td> <td>PM070WT4</td> <td>40</td> <td></td> </tr> <tr> <td>1</td> <td>50-0301681</td> <td>瓦楞隔板緩衝材料</td> <td>1</td> <td>上蓋+底座</td> </tr> </table>		4	50-0100111	CARTON	1		3	50-0500071	PINK Bag 190*190mm	40	抗靜電	2		PM070WT4	40		1	50-0301681	瓦楞隔板緩衝材料	1	上蓋+底座	<table border="1" style="width:100%; border-collapse: collapse;"> <thead> <tr> <th>ITEM</th> <th>PART NO.</th> <th>DESCRIPTION</th> <th>QTY</th> <th>REMARK</th> </tr> </thead> <tbody> <tr> <td>4</td> <td>50-0100111</td> <td>CARTON</td> <td>1</td> <td></td> </tr> <tr> <td>3</td> <td>50-0500071</td> <td>PINK Bag 190*190mm</td> <td>40</td> <td>抗靜電</td> </tr> <tr> <td>2</td> <td></td> <td>PM070WT4</td> <td>40</td> <td></td> </tr> <tr> <td>1</td> <td>50-0301681</td> <td>瓦楞隔板緩衝材料</td> <td>1</td> <td>上蓋+底座</td> </tr> </tbody> </table>		ITEM	PART NO.	DESCRIPTION	QTY	REMARK	4	50-0100111	CARTON	1		3	50-0500071	PINK Bag 190*190mm	40	抗靜電	2		PM070WT4	40		1	50-0301681	瓦楞隔板緩衝材料	1	上蓋+底座
4	50-0100111	CARTON	1																																															
3	50-0500071	PINK Bag 190*190mm	40	抗靜電																																														
2		PM070WT4	40																																															
1	50-0301681	瓦楞隔板緩衝材料	1	上蓋+底座																																														
ITEM	PART NO.	DESCRIPTION	QTY	REMARK																																														
4	50-0100111	CARTON	1																																															
3	50-0500071	PINK Bag 190*190mm	40	抗靜電																																														
2		PM070WT4	40																																															
1	50-0301681	瓦楞隔板緩衝材料	1	上蓋+底座																																														
MTL.SPEC.		UNSPECIFIED TOL'S		REMARK																																														
		ANGLE																																																
		ROUGHNESS																																																
APPROVE	Frank Shin	07.04.20	SCALE	UNIT	SHEET																																													
CHECK	Frank Shin	07.04.20			1 of 1																																													
DRAWN	Joseph	07.04.20	MTL.NO.		DWG. TITLE																																													
					7" WVGA+PCB(TTL)+T/P Packing																																													
			DWG. FILE:		REV. 01																																													
					A4 SIZE																																													

Revision History

Rev.	Issued Date	Revised Contents	Remark
0.1	Oct.24.2006	New	
1.0	Jan.03.2006	Release version	
2.0	Apr.17,2007	Modify Block Diagram	
3.0	Apr.30,2007	Modify Packing Diagram	