

PM150CVA120

FLAT-BASE TYPE
INSULATED PACKAGE

TERMINAL CODE

- | | |
|----------|----------|
| 1. WFO | 11. UP |
| 2. VWPC | 12. VUP1 |
| 3. WP | 13. NC |
| 4. VWP1 | 14. Fo |
| 5. VFO | 15. VNC |
| 6. VVPC | 16. VN1 |
| 7. VP | 17. UN |
| 8. VVP1 | 18. VN |
| 9. UFO | 19. WN |
| 10. VUVC | |

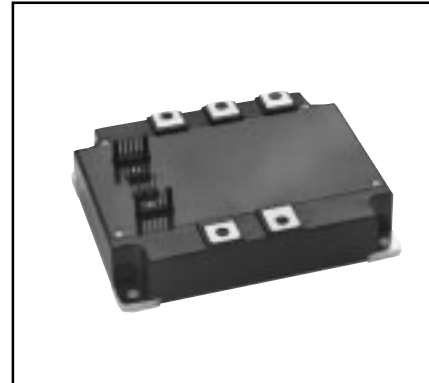
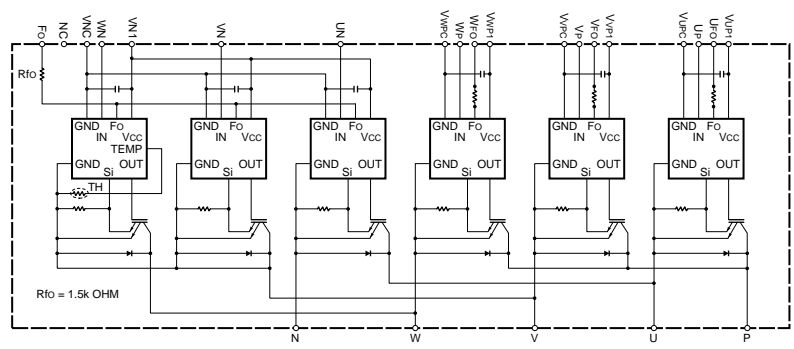
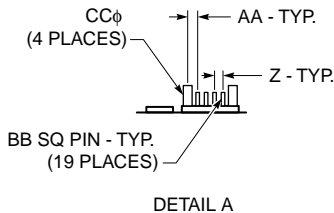
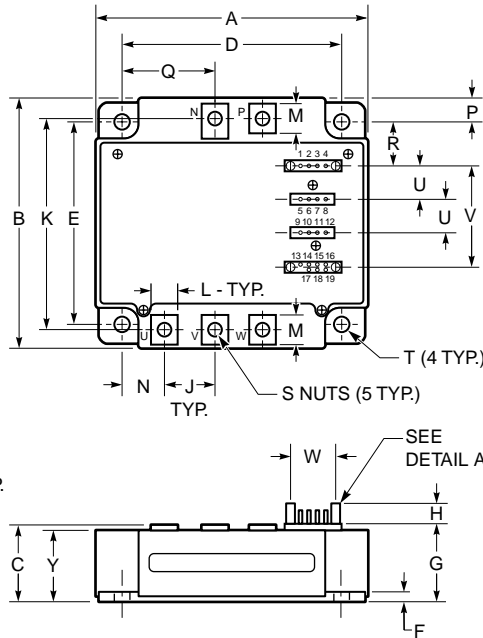

Description:

Mitsubishi Intelligent Power Modules are isolated base modules designed for power switching applications operating at frequencies to 20kHz. Built-in control circuits provide optimum gate drive and protection for the IGBT and free-wheel diode power devices.

Features:

- Complete Output Power Circuit
- Gate Drive Circuit
- Protection Logic
 - Short Circuit
 - Over Temperature
 - Under Voltage

Applications:

- Inverters
- UPS
- Motion/Servo Control
- Power Supplies

Ordering Information:

Example: Select the complete part number from the table below -i.e. PM150CVA120 is a 1200V, 150 Ampere Intelligent Power Module.

Type	Current Rating Amperes	V _{CES} Volts (x 10)
PM	150	120

Outline Drawing and Circuit Diagram

Dimensions	Inches	Millimeters
A	5.31	135.0
B	4.33	110.0
C	1.14 +0.04/-0.02	29.0 +1.0/-0.5
D	4.74±0.010	120.5±0.25
E	3.76±0.010	95.5±0.25
F	0.16	4.0
G	1.14	29.0
H	0.41	10.4
J	1.10	28.0
K	3.82	97.0
L	0.55	14.0
M	0.59	15.0
N	0.88	22.25

Dimensions	Inches	Millimeters
P	0.29	7.25
Q	1.98	50.25
R	1.03	26.25
S	M5 Metric	M5
T	0.22 Dia.	Dia. 5.5
U	0.56±0.010	14.1±0.25
V	1.72±0.012	43.57±0.3
W	0.57±0.012	14.6±0.3
Y	1.04	26.5
Z	0.10±0.010	2.54±0.25
AA	1.37±0.010	3.49±0.25
BB	0.02 SQ	0.64 SQ
CC	0.12 +0.04/-0.02	3.0 +1.0/-0.5

PM150CVA120

FLAT-BASE TYPE
INSULATED PACKAGE

Absolute Maximum Ratings, $T_j = 25^\circ\text{C}$ unless otherwise specified

Ratings	Symbol	PM150CVA120	Units
Power Device Junction Temperature	T_j	-20 to 150	$^\circ\text{C}$
Storage Temperature	T_{stg}	-40 to 125	$^\circ\text{C}$
Case Operating Temperature	T_C	-20 to 100	$^\circ\text{C}$
Mounting Torque, M5 Mounting Screws	—	2.5 ~ 3.5	N · m
Mounting Torque, M5 Main Terminal Screws	—	2.5 ~ 3.5	N · m
Module Weight (Typical)	—	1000	Grams
Supply Voltage (Applied between P - N)	$V_{\text{CC(surge)}}$	1000	Volts
Supply Voltage Protected by SC ($V_D = 13.5 \sim 16.5\text{V}$, Inverter Part, $T_j = 125^\circ\text{C}$ Start)	$V_{\text{CC(prot.)}}$	800	Volts
Isolation Voltage (Main Terminal to Baseplate, AC 1 min.)	V_{iso}	2500	Vrms

Control Sector

Supply Voltage (Applied between $V_{\text{UP1}}-V_{\text{UPC}}$, $V_{\text{VP1}}-V_{\text{VPC}}$, $V_{\text{WP1}}-V_{\text{WPC}}$, $V_{\text{N1}}-V_{\text{NC}}$)	V_D	20	Volts
Input Voltage (Applied between U_P-V_{UPC} , V_P-V_{VPC} , W_P-V_{WPC} , $U_N \cdot V_N \cdot W_N-V_{\text{NC}}$)	V_{CIN}	20	Volts
Fault Output Supply Voltage (Applied between $U_{\text{FO}}-V_{\text{UPC}}$, $V_{\text{FO}}-V_{\text{VPC}}$, $W_{\text{FO}}-V_{\text{WPC}}$, F_O-V_{NC})	V_{FO}	20	Volts
Fault Output Current (Sink Current at U_{FO} , V_{FO} , W_{FO} and F_O Terminal)	I_{FO}	20	mA

IGBT Inverter Sector

Collector-Emitter Voltage ($V_D = 15\text{V}$, $V_{\text{CIN}} = 15\text{V}$)	V_{CES}	1200	Volts
Collector Current, ($T_C = 25^\circ\text{C}$)	I_C	150	Amperes
Peak Collector Current, ($T_C = 25^\circ\text{C}$)	I_{CP}	300	Amperes
Collector Dissipation ($T_C = 25^\circ\text{C}$)	P_C	780	Watts

PM150CVA120

FLAT-BASE TYPE
INSULATED PACKAGE

Electrical and Mechanical Characteristics, $T_j = 25^\circ\text{C}$ unless otherwise specified

Characteristics	Symbol	Test Conditions	Min.	Typ.	Max.	Units
Control Sector						
Short Circuit Trip Level	SC	$-20^\circ\text{C} \leq T_j \leq 125^\circ\text{C}$, $V_D = 15\text{V}$	200	—	—	Amperes
Short Circuit Current Delay Time	$t_{\text{off(SC)}}$	$V_D = 15\text{V}$	—	10	—	μs
Over Temperature Protection	OT	Trip Level	100	110	120	$^\circ\text{C}$
($V_D = 15\text{V}$, Lower Arm)	OT_r	Reset Level	85	95	105	$^\circ\text{C}$
Supply Circuit Under Voltage Protection	UV	Trip Level	11.5	12.0	12.5	Volts
($-20^\circ\text{C} \leq T_j \leq 125^\circ\text{C}$)	UV_r	Reset Level	—	12.5	—	Volts
Circuit Current	I_D	$V_D = 15\text{V}$, $V_{\text{CIN}} = 15\text{V}$, $V_{\text{N1}}-V_{\text{NC}}$	—	72	100	mA
		$V_D = 15\text{V}$, $V_{\text{CIN}} = 15\text{V}$, $V_{\text{XP1}}-V_{\text{XPC}}$	—	24	34	mA
Input ON Threshold Voltage	$V_{\text{th(on)}}$	Applied between U_P-V_{UPC} , V_P-V_{VPC} ,	1.2	1.5	1.8	Volts
Input OFF Threshold Voltage	$V_{\text{th(off)}}$	W_P-V_{WPC} , $U_N \cdot V_N \cdot W_N-V_{\text{NC}}$	1.7	2.0	2.3	Volts
Fault Output Current	$I_{\text{FO(H)}}$	$V_D = 15\text{V}$, $V_{\text{FO}} = 15\text{V}$	—	—	0.01	mA
	$I_{\text{FO(L)}}$	$V_D = 15\text{V}$, $V_{\text{FO}} = 15\text{V}$	—	10	15	mA
Minimum Fault Output Pulse Width	t_{FO}	$V_D = 15\text{V}$	1.0	1.8	—	ms

PM150CVA120

FLAT-BASE TYPE
INSULATED PACKAGEElectrical and Mechanical Characteristics, $T_j = 25^\circ\text{C}$ unless otherwise specified

Characteristics	Symbol	Test Conditions	Min.	Typ.	Max.	Units
IGBT Inverter Sector						
Collector-Emitter Cutoff Current	I_{CES}	$V_{CE} = V_{CES}, V_D = 15\text{V}, T_j = 25^\circ\text{C}$	—	—	1.0	mA
		$V_{CE} = V_{CES}, V_D = 15\text{V}, T_j = 125^\circ\text{C}$	—	—	10.0	mA
FWDi Forward Voltage	V_{EC}	$-I_C = 150\text{A}, V_D = 15\text{V}, V_{CIN} = 15\text{V}$	—	2.50	3.50	Volts
Collector-Emitter Saturation Voltage	$V_{CE(sat)}$	$V_D = 15\text{V}, V_{CIN} = 0\text{V}, I_C = 150\text{A},$ Pulsed, $T_j = 25^\circ\text{C}$	—	2.65	3.30	Volts
		$V_D = 15\text{V}, V_{CIN} = 0\text{V}, I_C = 150\text{A},$ Pulsed, $T_j = 125^\circ\text{C}$	—	2.60	3.25	Volts
Inductive Load Switching Times	t_{on}		0.4	0.9	2.3	μs
	t_{rr}	$V_D = 15\text{V}, V_{CIN} = 0 \leftrightarrow 15\text{V}$	—	0.2	0.3	μs
	$t_{C(on)}$	$V_{CC} = 600\text{V}, I_C = 150\text{A},$ $T_j = 125^\circ\text{C}$	—	0.4	1.0	μs
	t_{off}		—	2.4	3.4	μs
	$t_{C(off)}$		—	0.7	1.2	μs

Thermal Characteristics

Characteristic	Symbol	Condition	Min.	Typ.	Max.	Units
Junction to Case Thermal Resistance	$R_{th(j-c)Q}$	Each Inverter IGBT	—	—	0.16	$^\circ\text{C/Watt}$
	$R_{th(j-c)F}$	Each Inverter FWDi	—	—	0.26	$^\circ\text{C/Watt}$
Contact Thermal Resistance	$R_{th(c-f)}$	Case to Fin Per Module, Thermal Grease Applied	—	—	0.018	$^\circ\text{C/Watt}$

Recommended Conditions for Use

Characteristic	Symbol	Condition	Value	Units
Supply Voltage	V_{CC}	Applied across P-N Terminals	≤ 800	Volts
	$V_{CE(surge)}$	Applied across P-N Terminals	≤ 1000	Volts
	V_D	Applied between $V_{UP1}-V_{UPC},$ $V_{VP1}-V_{VPC}, V_{WP1}-V_{WPC}, V_{N1}-V_{NC}$	15 ± 1.5	Volts
Input ON Voltage	$V_{CIN(on)}$	Applied between	≤ 0.8	Volts
Input OFF Voltage	$V_{CIN(off)}$	$U_P-V_{UPC}, V_P-V_{VPC}, W_P-V_{WPC},$ $U_N \cdot V_N \cdot W_N-V_{NC}$	≥ 4.0	Volts
Arm Shoot-Through Blocking Time	t_{dead}	For IPM's each Input Signal	≥ 3.0	μs

PM150CVA120

FLAT-BASE TYPE
INSULATED PACKAGE

SATURATION VOLTAGE CHARACTERISTICS (TYPICAL)

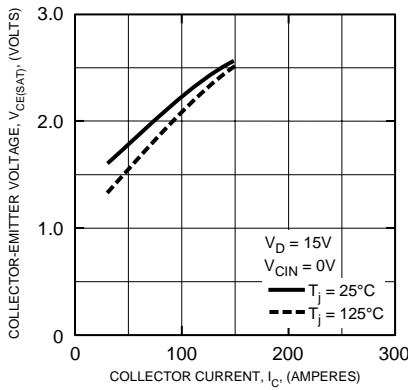

COLLECTOR-EMITTER SATURATION VOLTAGE CHARACTERISTICS (TYPICAL)

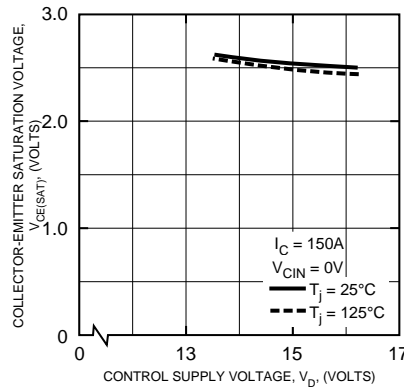

OUTPUT CHARACTERISTICS (TYPICAL)

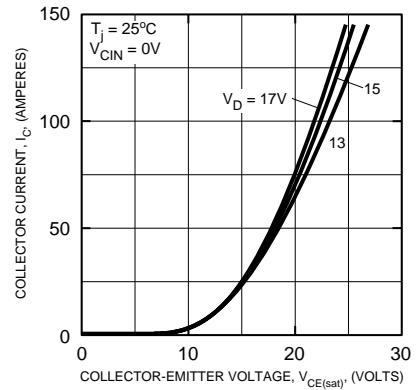

SWITCHING TIME VS. COLLECTOR CURRENT (TYPICAL)

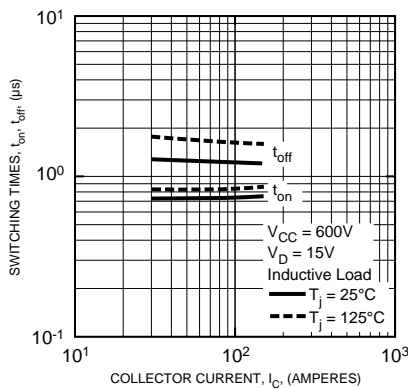

SWITCHING TIME VS. COLLECTOR CURRENT (TYPICAL)

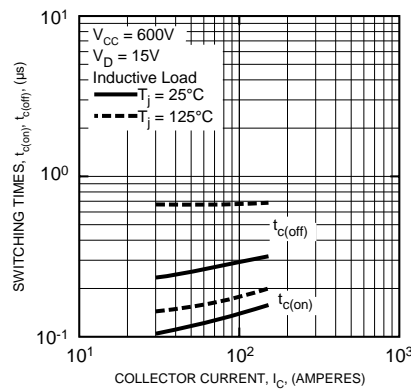

SWITCHING LOSS CHARACTERISTICS (TYPICAL)

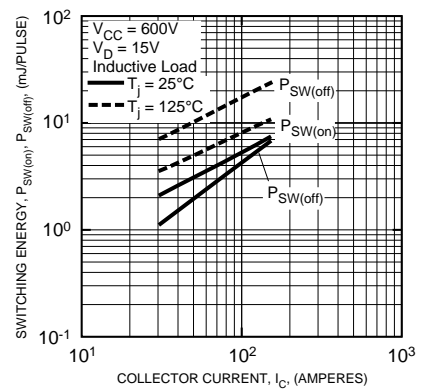

REVERSE RECOVERY CURRENT VS. COLLECTOR CURRENT (TYPICAL)

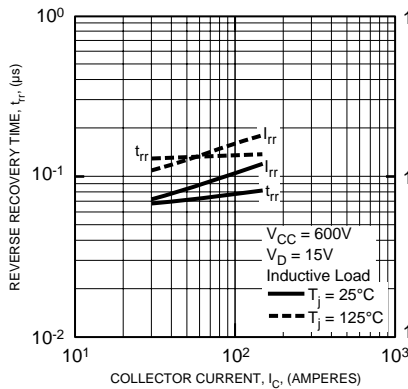

DIODE FORWARD CHARACTERISTICS

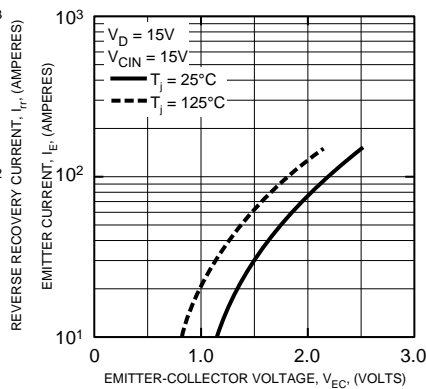

CIRCUIT CURRENT VS. CARRIER FREQUENCY

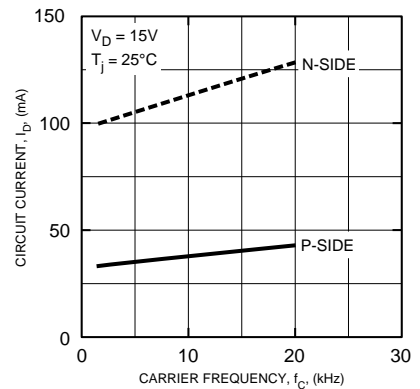

PM150CVA120

FLAT-BASE TYPE
INSULATED PACKAGE

