

**Single Supply RFIC Power Amplifier**

**2400 to 2500 MHz Operation**

**Features**

- 29 dBm Output Power
- 40% Efficiency
- Single 3V to 5V Supply - Class A Operation
- Linear Class AB Operation ( Requires  $-V_{G2}$  )\*
- 50  $\Omega$  Matched Input, Simple External Output Match
- Unconditionally Stable
- NEW PM-SOP™ Package (No bottom side contact)

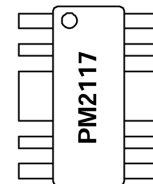

**PM-SOP™**  
**Plastic Package**

L= .196" x W= .079" x H=.042"

**Applications**

- FHSS or DSSS ISM Band Transmitters
- RFID Interrogators
- MMDS Band Transmitters

**Description**

The PM2117 is a two-stage high efficiency GaAs RFIC power amplifier developed for applications in the 2400 MHz ISM band. The input and interstage matching networks are included on chip. A simple series line, shunt capacitor output matching network keeps the additional component count to just 9 parts, including all bypass and blocking capacitors. In single supply mode both stages are inherently biased for Class A operation: the current will remain constant, or increase somewhat under input power back-off. Operating from a single 5 volt supply in Class A operation the PM2117 can produce over 800 mW saturated output power with 40% typical power added efficiency and approximately 400 mW from a single 3 V supply with a typical supply current of less than 300 mA

\* NOTE: For linear Class AB operation, supplying a negative 0.3 volts to  $V_{G2}$  will reduce current consumption when in an idle or backed off power mode. (See Application Note 2117AB for more details on linear operation.)

**Electrical Characteristics**

Typical Specifications for  $V_{DD} = 5.0V$   $T_A = +25^\circ C$  as tested in 50  $\Omega$  system, using matching circuit on page 3.

**Minimum and Maximum Specifications are Guaranteed over Frequency and Temperature**

Parameter	Symbol	Conditions	Min	Typ	Max	Units
Frequency Range	$f$		2400		2500	MHz
Power Output	$P_{SAT}$	$P_{IN} = 6$ dBm	27.5	29		dBm
Power Added Efficiency	$\eta$	$P_{IN} = 6$ dBm	30	40		%
Small Signal Gain	G			26		dB
Input Return Loss	$S_{11}$			14		dB
Output Power at 1dB Comp.	$P_{1dB}$			27		dBm
Operating Drain Current	$I_{DD}$	$P_{OUT} = P_{SAT}$		430	500	mA
Stability Factor	$k$	With or without match	1.5			
Thermal Resistance	$\theta_{JC}$	Junction to GND lead		35		$^\circ C/W$

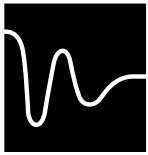

**Absolute Maximum Ratings**

Characteristics	Symbol	Value	Units
Drain Voltage	$V_{DD1,2}$	+7.0	V
Bias Current	$I_{DS}$	900	mA
RF Input Power	$P_{IN}$	+15.0	dBm
Power Dissipation	$P_{DISS}$	1.9	W
Load VSWR	VSWR	10:1	
Operating Temperature	$T_{OP}$	-40 to +85	°C
Junction Temperature	$T_J$	150	°C
Storage Temperature Range	$T_{STG}$	-65 to +150	°C

Caution: Operating beyond the specified rating for any of these parameters may cause permanent damage to device.

**Pin-Out**

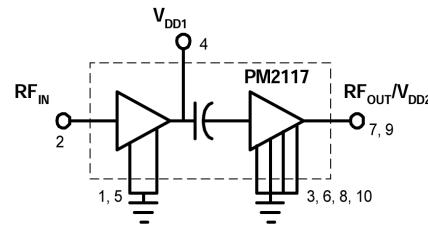

**Typical Performance Characteristics**

(Obtained using the suggested matching circuit shown on page 3.)

**Output Power and Efficiency vs. Frequency**

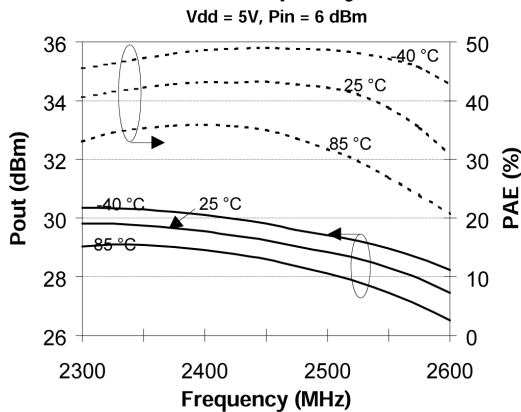

**Output Power, Efficiency and Current**

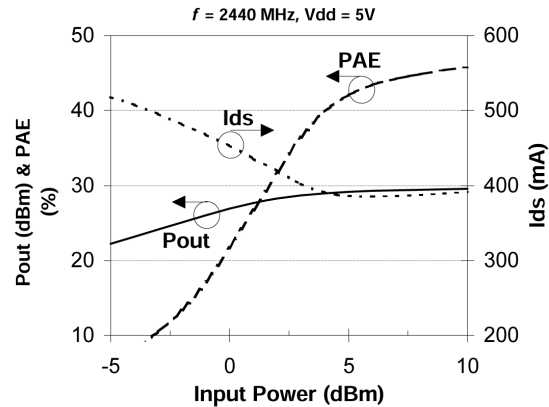

**Output Power & Supply Current Vs Vdd**

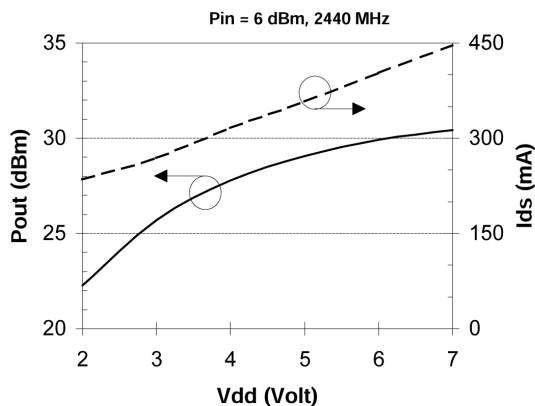

**Harmonic Levels at Saturated Output Power**

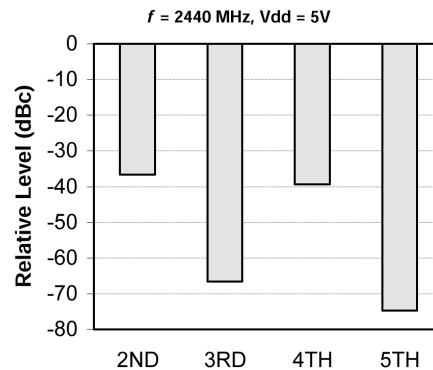

## Application Information

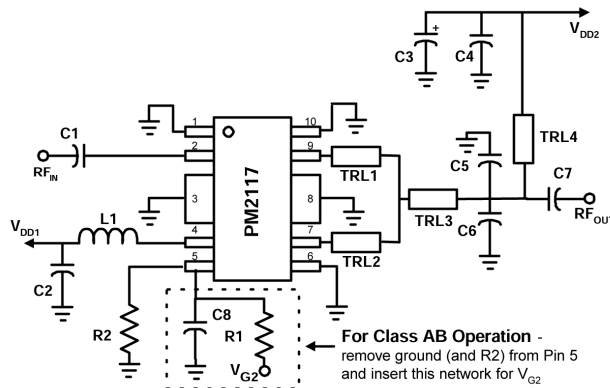

### Suggested Matching Circuit for 2.4 to 2.5 GHz Operation.

The PM2117 is internally matched on the input and interstage, so only output matching is required. A series line, shunt C network is required to match the output. Pins 7 and 9 provide the RF output. Separate transmission lines (TRL1 and TRL2) on each output provide a small impedance transformation before the main series transmission line (TRL3). Two parallel capacitors, C5 and C6 complete the series-L, shunt-C matching network. Two 0402-size capacitors are used for the equivalent shunt C to reduce parasitic inductance effects within the capacitors. L1 is required for supply line isolation to avoid excess gain at low frequencies. For Class AB Operation R1 and C8 replaces the direct connection to ground as shown above.  $V_{G2} = -0.3$  Vdc. (See Application Note 2117AB)

Part	Value / Type	Size
C5, C6	1.2 pF NPO	0402
C2	1000 pF X7R	0603
C1, C7	5.6 pF NPO	0603
C4	100 pF NPO	0603
C3	6.8 $\mu$ F TANT	1206
L1	12 nH	0802
R2	50 $\Omega$	0603
TRL1, 2	$\theta = 15^\circ$ , $Z_0 = 60 \Omega$	@2.44 GHz
TRL3	$\theta = 12^\circ$ , $Z_0 = 50 \Omega$	@2.44 GHz
TRL4	$\theta = 90^\circ$ , $Z_0 = 105 \Omega$	@2.44 GHz

Required only for Class AB Operation:		
R1	10 $\Omega$	0603
C8	1000 pF X7R	0603

## PCB Layout (PCB material = 0.018" FR4, $\epsilon_r = 4$ )

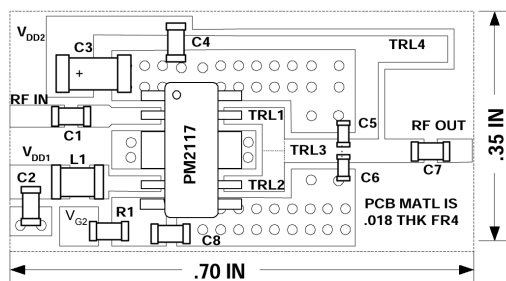

The placement and size (0402) of C5 and C6 are critical with respect to the IC package and the TRL's. Care should be taken to produce trace dimensions to achieve the TRL impedance's and phase lengths shown above. Dashed lines in this layout represent reference planes. All other components and traces may be moved to accommodate layout constraints. Pins 3 and 8 provide the source grounding for the FET's. Via holes (.010" dia.) should be placed in close proximity to the lead edges to minimize ground inductance.

**Note: R1 and C8 are for Class AB operation. For single supply Class A operation, remove R1 and replace C8 with R2. There is no  $V_{G2}$  in Class A operation.**

## Biasing

The PM2117 requires no negative bias for Class A operation because both FET's operate at 0 volts  $V_{GS}$ . At high input RF drive levels ( $> 3$  dBm), efficient PA operation is possible because the output current swings between zero and  $I_{max}$ , which is roughly 200% above  $I_{DSS}$ . Under saturated operation, the operating DC current is  $1/3 I_{max}$ . If the RF drive is backed off, the drain current rises to  $I_{DSS}$ . As such, "small-signal" operation will cause the current draw to increase by about 50%, to about 600 mA. This will not cause damage to the device for a short duration. Class AB operation is suggested and is accomplished by applying a negative 0.3 volts ( $V_{G2}$ ) and follow the schematic above. At 5 V Class A operation, the maximum duty cycle for small-signal operation is limited to 60% in order to remain below the 150 °C maximum recommended average junction temperature. Continuous operation is possible at 3V. For saturated operation, the drain efficiency increases to allow 100% duty cycle up to 5V.

PM2117 Small-Signal S-Parameters (V <sub>DD</sub> = 5V, Class A Operation)										
Freq.	S11		S21		S12		S22		MAG	k-Factor
	MAG	ANG	MAG	ANG	MAG	ANG	MAG	ANG	dB	
500	0.820	153.5	2.959	-0.6	0.0024	29.3	0.612	-159.2	16.3	14.91
1000	0.789	126.3	1.737	-136.7	0.0037	-24.9	0.791	177.0	13.3	10.39
1500	0.733	96.9	0.889	-127.7	0.0034	-102.1	0.706	169.7	5.3	37.88
2000	0.606	54.5	6.292	167.4	0.0012	104.0	0.648	172.6	20.3	23.98
2200	0.432	23.5	11.070	108.6	0.0007	-65.1	0.734	177.3	25.0	24.55
2300	0.285	9.4	12.201	71.1	0.0061	-77.4	0.791	174.0	26.4	2.27
2350	0.226	7.0	11.674	55.5	0.0064	-92.9	0.806	171.9	26.1	2.43
2400	0.168	7.3	11.386	37.9	0.0068	-112.5	0.816	169.7	26.0	2.00
2450	0.124	9.8	11.238	22.9	0.0070	-125.3	0.821	167.6	26.0	2.17
2500	0.100	17.6	10.380	9.6	0.0061	-133.4	0.818	165.7	25.2	2.57
2550	0.080	29.3	10.134	-5.0	0.0054	-143.7	0.815	163.8	24.9	3.14
2600	0.071	34.7	9.307	-15.8	0.0058	-152.0	0.808	162.6	24.0	3.18
3000	0.038	-165.5	6.245	-97.6	0.0076	160.5	0.749	156.1	19.5	4.67
4000	0.329	175.6	2.871	103.9	0.0116	9.8	0.649	146.5	12.0	7.66
5000	0.482	145.3	1.960	-41.6	0.0142	-99.4	0.599	126.7	8.9	8.89
6000	0.510	110.1	1.410	177.4	0.0212	143.1	0.521	98.6	5.7	9.00

## Thermal Considerations

The fused leads (pins 3, 8) on the PM2117 provide most of the thermal path from the device junction. In the absence of other heat conducting structures, we recommend 3 sq-in of continuous copper ground plane per watt of dissipated power (Note:  $P_{DISS} = \text{Duty Cycle} \times (P_{DC} - P_{RF})$ ). 2 oz. copper is recommended for the ground plane layer, with a minimum of 20 via holes (.010 diameter) to the component side in close proximity to the ground leads.

### Pin Connections

Pin Number	Function
1	GND
2	RF <sub>IN</sub>
3	GND
4	V <sub>DD1</sub>
5	GND (Class A)
5	V <sub>G2</sub> (Class AB)
6	GND
7	RF <sub>OUT</sub> /V <sub>DD2</sub>
8	GND
9	RF <sub>OUT</sub> /V <sub>DD2</sub>
10	GND

## Part Number Marking:

The PM2117 shall be marked as follows:

Model Number Code: "117" = PM2117

Lot Date Code: "Y" = Last Digit of Year

"WW" = Week During Year

### PM-SOP™ Outline Drawing

