

# PMR780SN

N-channel  $\mu$ TrenchMOS™ standard level FET

Rev. 01 — 5 March 2004

Product data

## 1. Product profile

### 1.1 Description

N-channel enhancement mode field-effect transistor in a plastic package using TrenchMOS™ technology.

### 1.2 Features

- Surface mounted package
- Low on-state resistance
- Footprint 63% smaller than SOT23
- Fast switching.

### 1.3 Applications

- Driver circuits
- Switching in portable appliances.

### 1.4 Quick reference data

- $V_{DS} \leq 60$  V
- $I_D \leq 0.55$  A
- $P_{tot} \leq 0.53$  W
- $R_{DS(on)} \leq 920$  m $\Omega$ .

## 2. Pinning information

Table 1: Pinning - SOT416 (SC-75), simplified outline and symbol

| Pin | Description | Simplified outline     | Symbol        |
|-----|-------------|------------------------|---------------|
| 1   | gate (g)    | <p>Top view MBK090</p> | <p>MBB076</p> |
| 2   | source (s)  |                        |               |
| 3   | drain (d)   |                        |               |

**SOT416 (SC-75)**

## 3. Ordering information

Table 2: Ordering information

| Type number | Package |  | Version |
|-------------|---------|--|---------|
|             | Name    | Description                              |         |
| PMR780SN    | SC-75   | Plastic surface mounted package; 3 leads | SOT416  |



**PHILIPS**

## 4. Limiting values

**Table 3: Limiting values**

In accordance with the Absolute Maximum Rating System (IEC 60134).

| Symbol                    | Parameter                           | Conditions   | Min | Max      | Unit |
|---------------------------|-------------------------------------|--|-----|----------|------|
| $V_{DS}$                  | drain-source voltage (DC)           | $25\text{ °C} \leq T_j \leq 150\text{ °C}$   | -   | 60       | V    |
| $V_{DGR}$                 | drain-gate voltage (DC)             | $25\text{ °C} \leq T_j \leq 150\text{ °C}$ ; $R_{GS} = 20\text{ k}\Omega$            | -   | 60       | V    |
| $V_{GS}$                  | gate-source voltage (DC)            |  | -   | $\pm 20$ | V    |
| $I_D$                     | drain current (DC)                  | $T_{sp} = 25\text{ °C}$ ; $V_{GS} = 10\text{ V}$ ; <b>Figure 2 and 3</b>             | -   | 0.55     | A    |
|                           |                                     | $T_{sp} = 100\text{ °C}$ ; $V_{GS} = 10\text{ V}$ ; <b>Figure 2</b>                  | -   | 0.35     | A    |
| $I_{DM}$                  | peak drain current                  | $T_{sp} = 25\text{ °C}$ ; pulsed; $t_p \leq 10\text{ }\mu\text{s}$ ; <b>Figure 3</b> | -   | 1.1      | A    |
| $P_{tot}$                 | total power dissipation             | $T_{sp} = 25\text{ °C}$ ; <b>Figure 1</b>  | -   | 0.53     | W    |
| $T_{stg}$                 | storage temperature                 |  | -55 | +150     | °C   |
| $T_j$                     | junction temperature                |  | -55 | +150     | °C   |
| <b>Source-drain diode</b> |                                     |  |     |          |      |
| $I_S$                     | source (diode forward) current (DC) | $T_{sp} = 25\text{ °C}$  | -   | 0.44     | A    |
| $I_{SM}$                  | peak source (diode forward) current | $T_{sp} = 25\text{ °C}$ ; pulsed; $t_p \leq 10\text{ }\mu\text{s}$                   | -   | 0.88     | A    |



$$P_{der} = \frac{P_{tot}}{P_{tot(25^\circ C)}} \times 100\%$$

Fig 1. Normalized total power dissipation as a function of solder point temperature.

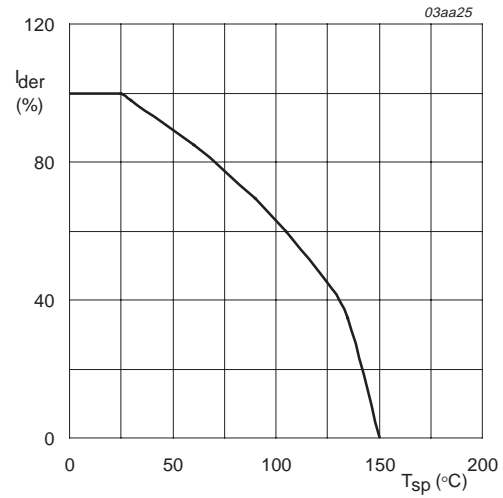

$$I_{der} = \frac{I_D}{I_{D(25^\circ C)}} \times 100\%$$

Fig 2. Normalized continuous drain current as a function of solder point temperature.

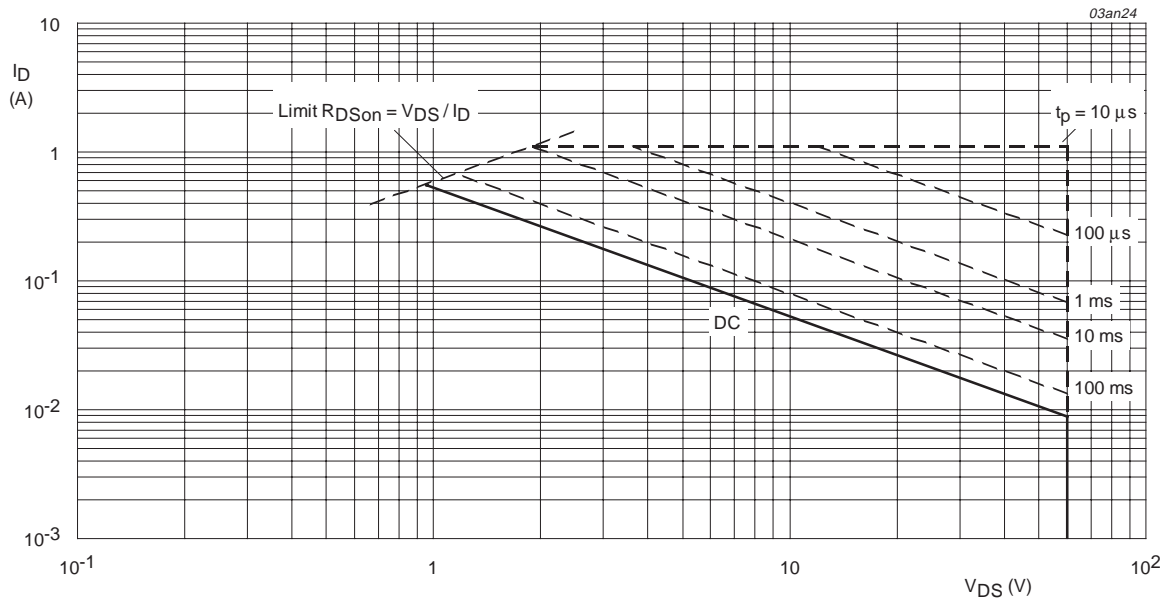

$T_{sp} = 25^\circ C$ ;  $I_{DM}$  is single pulse;  $V_{GS} = 10$  V.

Fig 3. Safe operating area; continuous and peak drain currents as a function of drain-source voltage.

## 5. Thermal characteristics

Table 4: Thermal characteristics

| Symbol         | Parameter  | Conditions | Min | Typ | Max | Unit |
|----------------|--|------------|-----|-----|-----|------|
| $R_{th(j-sp)}$ | thermal resistance from junction to solder point | Figure 4   | -   | -   | 235 | K/W  |

### 5.1 Transient thermal impedance

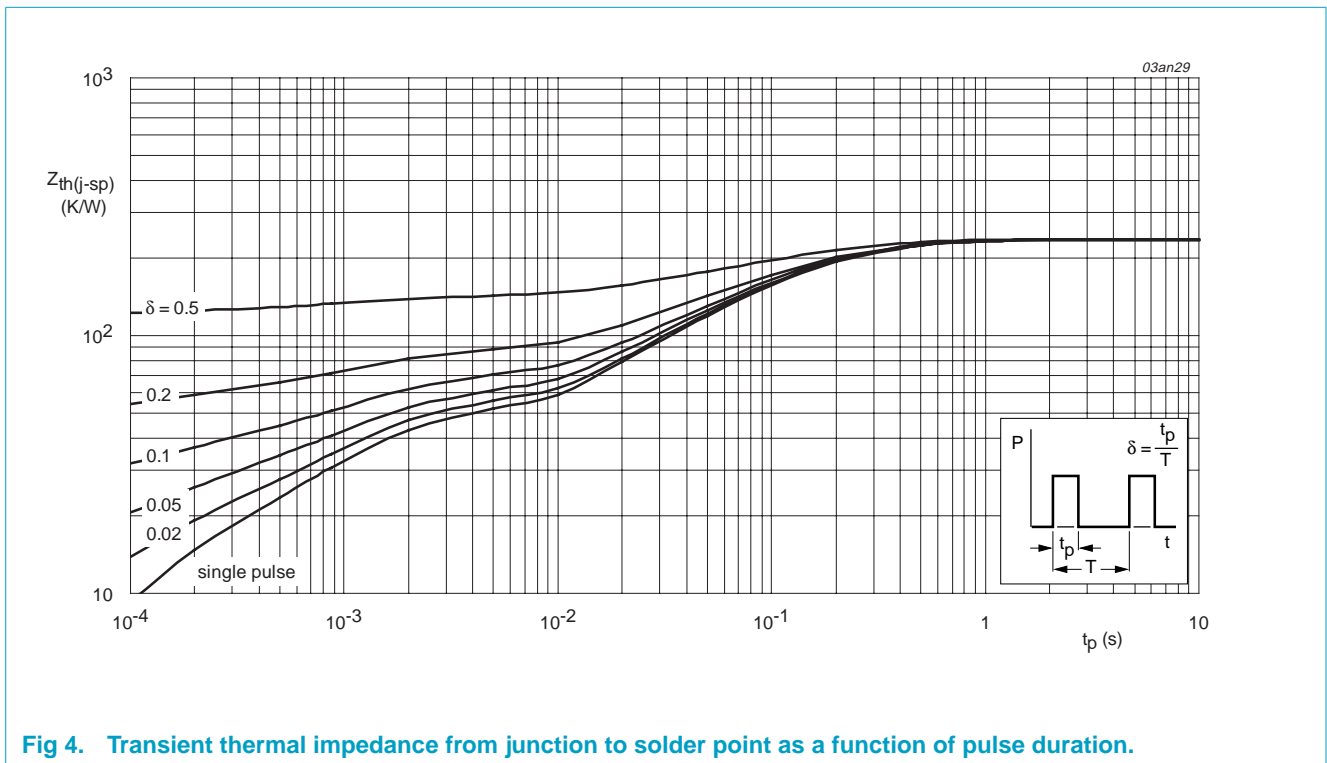

Fig 4. Transient thermal impedance from junction to solder point as a function of pulse duration.

## 6. Characteristics

**Table 5: Characteristics**

$T_j = 25\text{ }^\circ\text{C}$  unless otherwise specified.

| Symbol                         | Parameter                            | Conditions  | Min | Typ  | Max  | Unit          |
|--------------------------------|--------------------------------------|---|-----|------|------|---------------|
| <b>Static characteristics</b>  |                                      |   |     |      |      |               |
| $V_{(BR)DSS}$                  | drain-source breakdown voltage       | $I_D = 1\text{ }\mu\text{A}$ ; $V_{GS} = 0\text{ V}$<br>$T_j = 25\text{ }^\circ\text{C}$                  | 60  | -    | -    | V             |
|                                |                                      | $T_j = -55\text{ }^\circ\text{C}$   | 55  | -    | -    | V             |
| $V_{GS(th)}$                   | gate-source threshold voltage        | $I_D = 0.25\text{ mA}$ ; $V_{DS} = V_{GS}$ ; <b>Figure 9</b><br>$T_j = 25\text{ }^\circ\text{C}$          | 1   | 2    | 3    | V             |
|                                |                                      | $T_j = 150\text{ }^\circ\text{C}$   | 0.5 | -    | -    | V             |
|                                |                                      | $T_j = -55\text{ }^\circ\text{C}$   | -   | -    | 3.4  | V             |
| $I_{DSS}$                      | drain-source leakage current         | $V_{DS} = 60\text{ V}$ ; $V_{GS} = 0\text{ V}$<br>$T_j = 25\text{ }^\circ\text{C}$                        | -   | 0.05 | 1    | $\mu\text{A}$ |
|                                |                                      | $T_j = 100\text{ }^\circ\text{C}$   | -   | -    | 100  | $\mu\text{A}$ |
| $I_{GSS}$                      | gate-source leakage current          | $V_{GS} = \pm 20\text{ V}$ ; $V_{DS} = 0\text{ V}$  | -   | 10   | 100  | nA            |
| $R_{DS(on)}$                   | drain-source on-state resistance     | $V_{GS} = 10\text{ V}$ ; $I_D = 0.3\text{ A}$ ; <b>Figure 7 and 8</b><br>$T_j = 25\text{ }^\circ\text{C}$ | -   | 780  | 920  | m $\Omega$    |
|                                |                                      | $T_j = 150\text{ }^\circ\text{C}$   | -   | 1445 | 1700 | m $\Omega$    |
|                                |                                      | $V_{GS} = 4.5\text{ V}$ ; $I_D = 0.075\text{ A}$ ; <b>Figure 7 and 8</b>                                  | -   | 1100 | 1400 | m $\Omega$    |
| <b>Dynamic characteristics</b> |                                      |   |     |      |      |               |
| $Q_{g(tot)}$                   | total gate charge                    | $I_D = 1\text{ A}$ ; $V_{DD} = 30\text{ V}$ ; $V_{GS} = 10\text{ V}$ ; <b>Figure 13</b>                   | -   | 1.05 | -    | nC            |
| $Q_{gs}$                       | gate-source charge                   |   | -   | 0.2  | -    | nC            |
| $Q_{gd}$                       | gate-drain (Miller) charge           |   | -   | 0.22 | -    | nC            |
| $C_{iss}$                      | input capacitance                    | $V_{GS} = 0\text{ V}$ ; $V_{DS} = 30\text{ V}$ ; $f = 1\text{ MHz}$ ; <b>Figure 11</b>                    | -   | 23   | -    | pF            |
| $C_{oss}$                      | output capacitance                   |   | -   | 5    | -    | pF            |
| $C_{rss}$                      | reverse transfer capacitance         |   | -   | 3.5  | -    | pF            |
| $t_{d(on)}$                    | turn-on delay time                   | $V_{DD} = 30\text{ V}$ ; $R_L = 15\text{ }\Omega$ ; $V_{GS} = 10\text{ V}$ ; $R_G = 6\text{ }\Omega$      | -   | 2    | -    | ns            |
| $t_r$                          | rise time                            |   | -   | 4    | -    | ns            |
| $t_{d(off)}$                   | turn-off delay time                  |   | -   | 5    | -    | ns            |
| $t_f$                          | fall time                            |   | -   | 2.2  | -    | ns            |
| <b>Source-drain diode</b>      |                                      |   |     |      |      |               |
| $V_{SD}$                       | source-drain (diode forward) voltage | $I_S = 0.3\text{ A}$ ; $V_{GS} = 0\text{ V}$ ; <b>Figure 12</b>   | -   | 0.83 | 1.2  | V             |

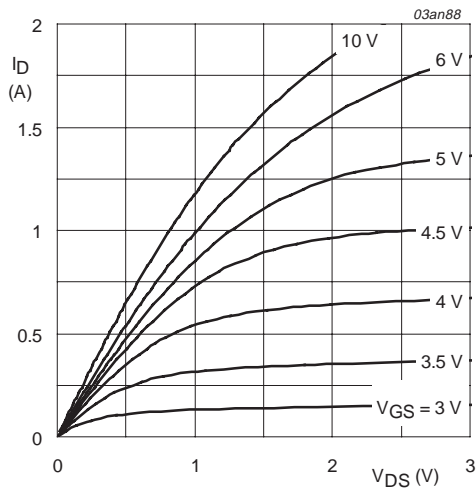

$T_j = 25^\circ\text{C}$

Fig 5. Output characteristics: drain current as a function of drain-source voltage; typical values.

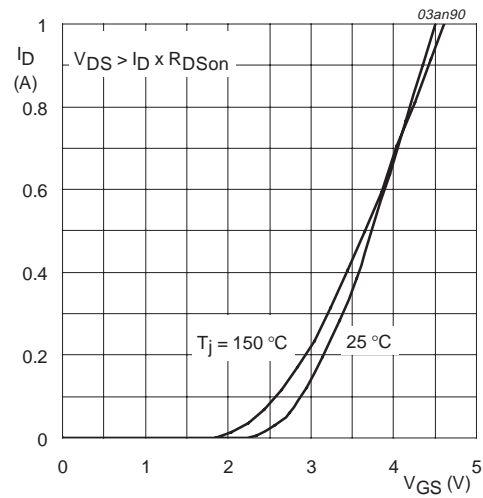

$T_j = 25^\circ\text{C}$  and  $150^\circ\text{C}$ ;  $V_{DS} > I_D \times R_{DSon}$

Fig 6. Transfer characteristics: drain current as a function of gate-source voltage; typical values.

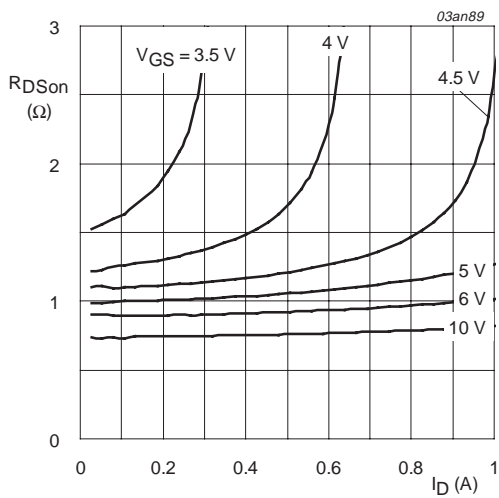

$T_j = 25^\circ\text{C}$

Fig 7. Drain-source on-state resistance as a function of drain current; typical values.

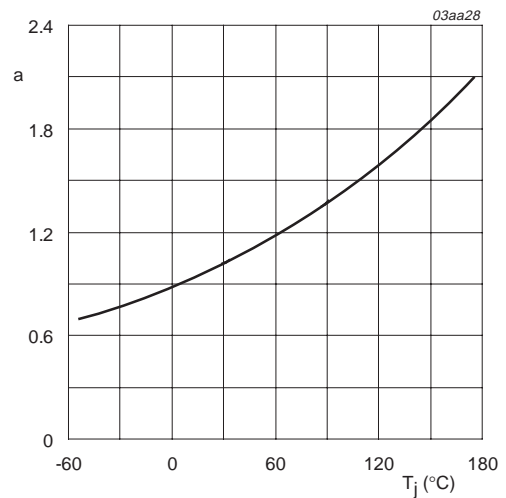

$$a = \frac{R_{DSon}}{R_{DSon}(25^\circ\text{C})}$$

Fig 8. Normalized drain-source on-state resistance factor as a function of junction temperature.

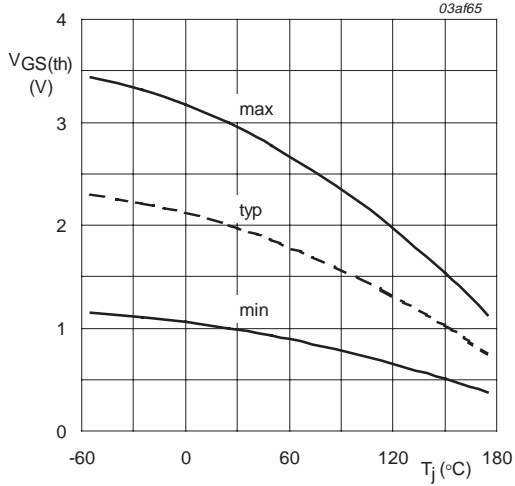

$I_D = 0.25 \text{ mA}; V_{DS} = V_{GS}$

Fig 9. Gate-source threshold voltage as a function of junction temperature.

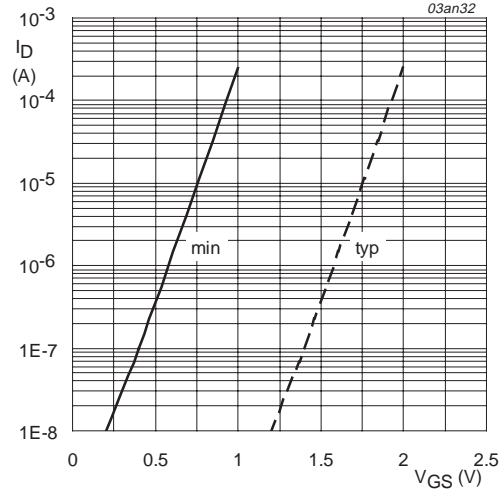

$T_j = 25 \text{ }^{\circ}C; V_{DS} = 5 \text{ V}$

Fig 10. Sub-threshold drain current as a function of gate-source voltage.

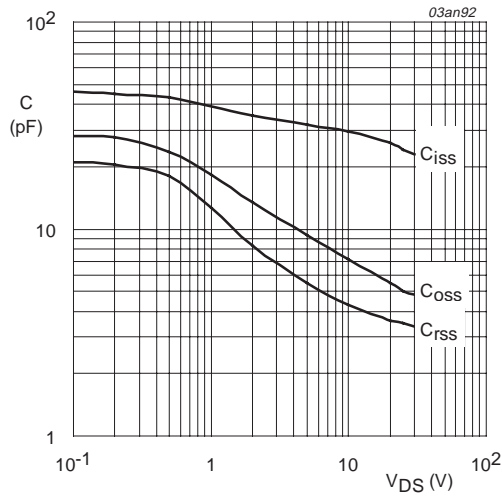

$V_{GS} = 0 \text{ V}; f = 1 \text{ MHz}$

Fig 11. Input, output and reverse transfer capacitances as a function of drain-source voltage; typical values.

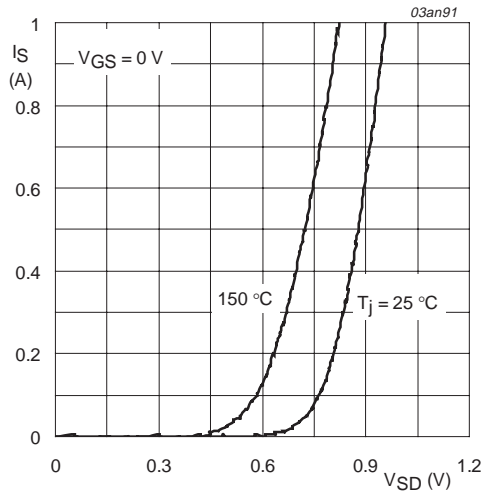

$T_j = 25\text{ }^\circ\text{C}$  and  $150\text{ }^\circ\text{C}$ ;  $V_{GS} = 0\text{ V}$

**Fig 12. Source (diode forward) current as a function of source-drain (diode forward) voltage; typical values.**

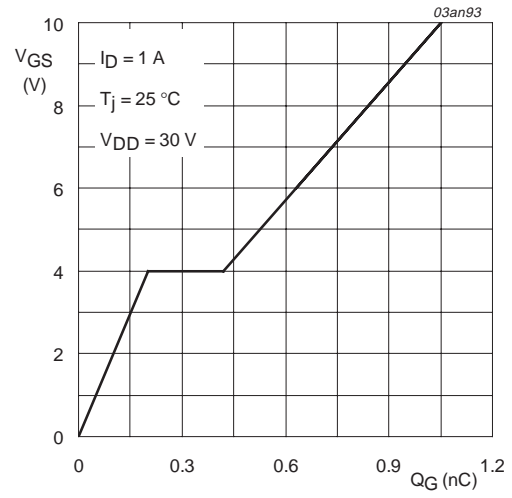

$I_D = 1\text{ A}$ ;  $V_{DD} = 30\text{ V}$

**Fig 13. Gate-source voltage as a function of gate charge; typical values.**



7. Package outline

Plastic surface mounted package; 3 leads

SOT416

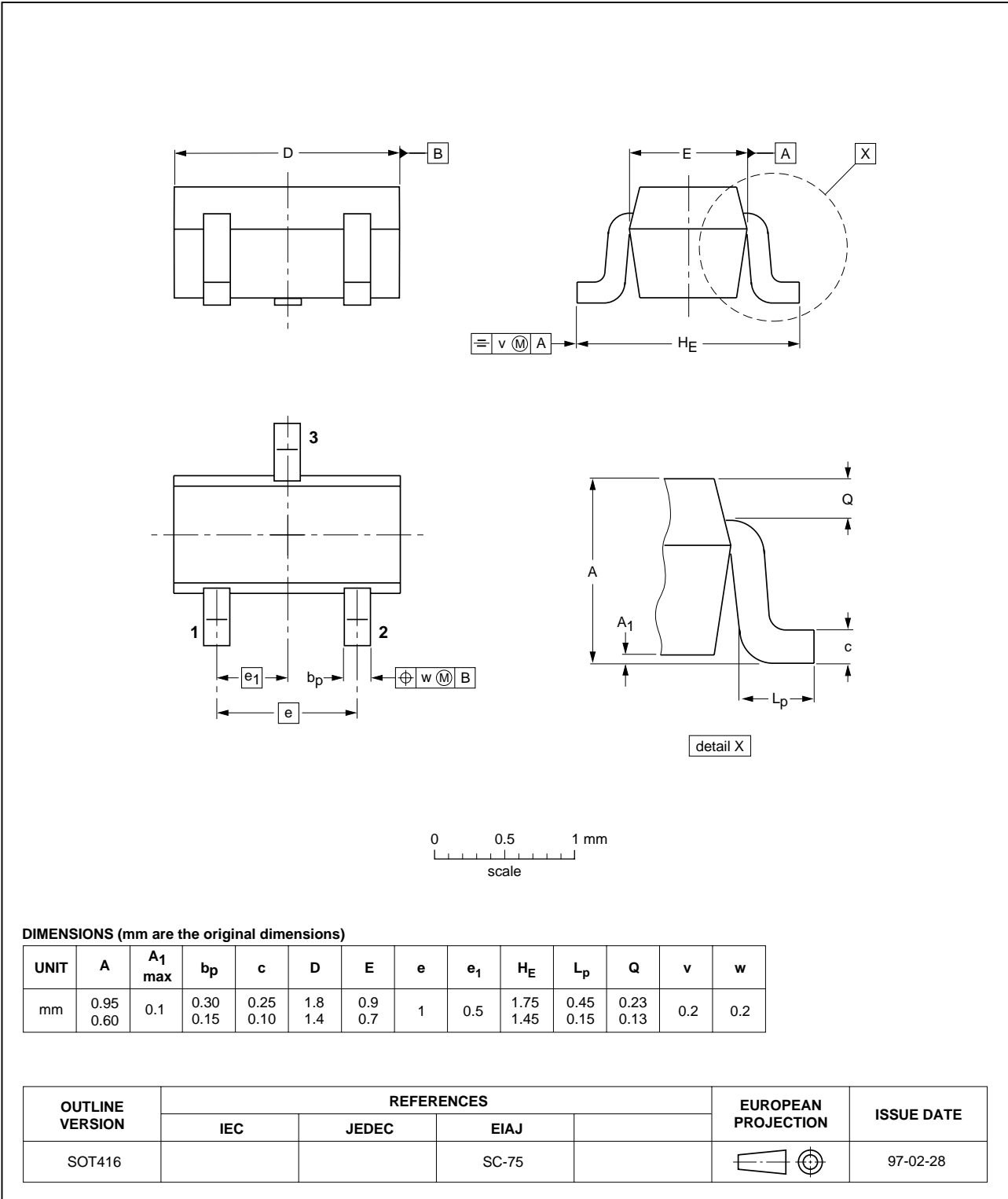
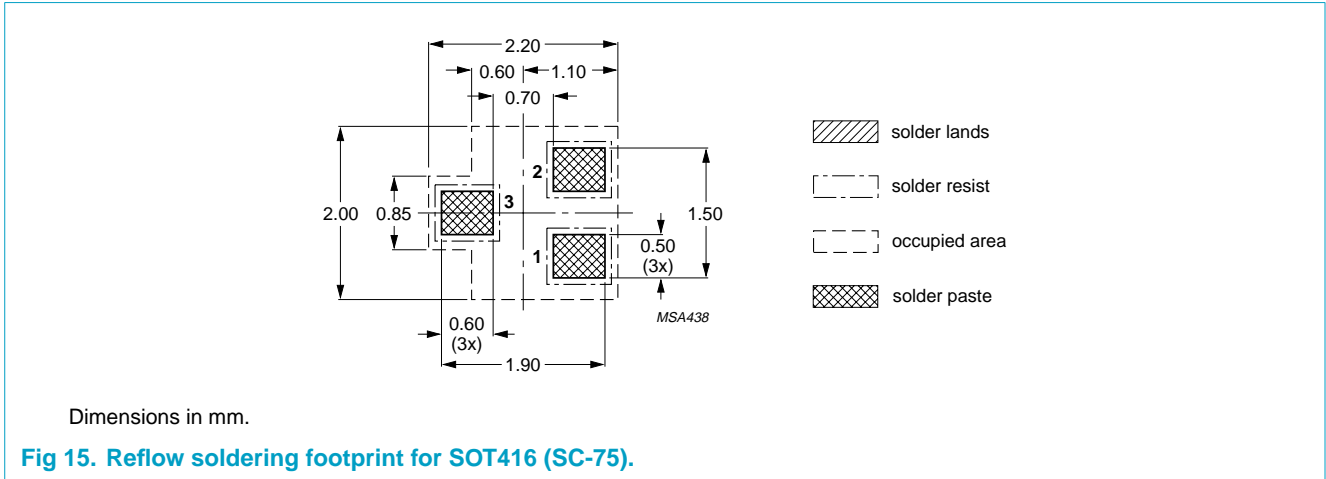

Fig 14. SOT416 (SC-75).

## 8. Soldering



## 9. Revision history

Table 6: Revision history

| Rev | Date     | CPCN | Description                   |
|-----|----------|------|-------------------------------|
| 01  | 20040305 | -    | Product data (9397 750 12666) |

## 10. Data sheet status

| Level | Data sheet status <sup>[1]</sup> | Product status <sup>[2][3]</sup> | Definition   |
|-------|----------------------------------|----------------------------------|--|
| I     | Objective data                   | Development                      | This data sheet contains data from the objective specification for product development. Philips Semiconductors reserves the right to change the specification in any manner without notice.  |
| II    | Preliminary data                 | Qualification                    | This data sheet contains data from the preliminary specification. Supplementary data will be published at a later date. Philips Semiconductors reserves the right to change the specification without notice, in order to improve the design and supply the best possible product.             |
| III   | Product data                     | Production                       | This data sheet contains data from the product specification. Philips Semiconductors reserves the right to make changes at any time in order to improve the design, manufacturing and supply. Relevant changes will be communicated via a Customer Product/Process Change Notification (CPCN). |

[1] Please consult the most recently issued data sheet before initiating or completing a design.

[2] The product status of the device(s) described in this data sheet may have changed since this data sheet was published. The latest information is available on the Internet at URL <http://www.semiconductors.philips.com>.

[3] For data sheets describing multiple type numbers, the highest-level product status determines the data sheet status.

## 11. Definitions

**Short-form specification** — The data in a short-form specification is extracted from a full data sheet with the same type number and title. For detailed information see the relevant data sheet or data handbook.

**Limiting values definition** — Limiting values given are in accordance with the Absolute Maximum Rating System (IEC 60134). Stress above one or more of the limiting values may cause permanent damage to the device. These are stress ratings only and operation of the device at these or at any other conditions above those given in the Characteristics sections of the specification is not implied. Exposure to limiting values for extended periods may affect device reliability.

**Application information** — Applications that are described herein for any of these products are for illustrative purposes only. Philips Semiconductors make no representation or warranty that such applications will be suitable for the specified use without further testing or modification.

## 12. Disclaimers

**Life support** — These products are not designed for use in life support appliances, devices, or systems where malfunction of these products can reasonably be expected to result in personal injury. Philips Semiconductors

customers using or selling these products for use in such applications do so at their own risk and agree to fully indemnify Philips Semiconductors for any damages resulting from such application.

**Right to make changes** — Philips Semiconductors reserves the right to make changes in the products - including circuits, standard cells, and/or software - described or contained herein in order to improve design and/or performance. When the product is in full production (status 'Production'), relevant changes will be communicated via a Customer Product/Process Change Notification (CPCN). Philips Semiconductors assumes no responsibility or liability for the use of any of these products, conveys no licence or title under any patent, copyright, or mask work right to these products, and makes no representations or warranties that these products are free from patent, copyright, or mask work right infringement, unless otherwise specified.

## 13. Trademarks

**TrenchMOS** — is a trademark of Koninklijke Philips Electronics N.V.

## Contact information

For additional information, please visit <http://www.semiconductors.philips.com>.

For sales office addresses, send e-mail to: [sales.addresses@www.semiconductors.philips.com](mailto:sales.addresses@www.semiconductors.philips.com).

Fax: +31 40 27 24825

## Contents

|           |                                      |           |
|-----------|--------------------------------------|-----------|
| <b>1</b>  | <b>Product profile</b> .....         | <b>1</b>  |
| 1.1       | Description .....                    | 1         |
| 1.2       | Features .....                       | 1         |
| 1.3       | Applications .....                   | 1         |
| 1.4       | Quick reference data .....           | 1         |
| <b>2</b>  | <b>Pinning information</b> .....     | <b>1</b>  |
| <b>3</b>  | <b>Ordering information</b> .....    | <b>1</b>  |
| <b>4</b>  | <b>Limiting values</b> .....         | <b>2</b>  |
| <b>5</b>  | <b>Thermal characteristics</b> ..... | <b>4</b>  |
| 5.1       | Transient thermal impedance .....    | 4         |
| <b>6</b>  | <b>Characteristics</b> .....         | <b>5</b>  |
| <b>7</b>  | <b>Package outline</b> .....         | <b>9</b>  |
| <b>8</b>  | <b>Soldering</b> .....               | <b>10</b> |
| <b>9</b>  | <b>Revision history</b> .....        | <b>10</b> |
| <b>10</b> | <b>Data sheet status</b> .....       | <b>11</b> |
| <b>11</b> | <b>Definitions</b> .....             | <b>11</b> |
| <b>12</b> | <b>Disclaimers</b> .....             | <b>11</b> |
| <b>13</b> | <b>Trademarks</b> .....              | <b>11</b> |

© Koninklijke Philips Electronics N.V. 2004.  
Printed in The Netherlands

All rights are reserved. Reproduction in whole or in part is prohibited without the prior written consent of the copyright owner.

The information presented in this document does not form part of any quotation or contract, is believed to be accurate and reliable and may be changed without notice. No liability will be accepted by the publisher for any consequence of its use. Publication thereof does not convey nor imply any license under patent- or other industrial or intellectual property rights.

Date of release: 5 March 2004

Document order number: 9397 750 12666



# PHILIPS

*Let's make things better.*