

PQxxxGN1HZPH Series

Low Voltage Operation, Compact Surface Mount type Low Power-Loss Voltage Regulators

■ Features

1. Low voltage output
($V_O=0.8$ to $1.2V$)
2. Low voltage operation: $V_{IN(MIN)}=1.7V$
3. Output current : 1A
4. Built-in overcurrent and overheat protection functions
5. Conform to Flow Soldering SC-63 package
6. RoHS directive compliant

■ Applications

1. AV equipment
2. OA equipment

■ Model Line-up

Output Voltage (TYP.)	Model No.
0.8V	PQ008GN1HZPH
1.0V	PQ010GN1HZPH
1.2V	PQ012GN1HZPH

■ Absolute Maximum Ratings

(Ta=25°C)

Parameter	Symbol	Rating	Unit
*1 Input voltage	V_{IN}	5.5	V
*1 Bias supply voltage	V_B	7	V
Output current	I_O	1.5	A
*2 Power dissipation	P_D	8	W
*3 Junction temperature	T_j	150	°C
Operating temperature	T_{opr}	-40 to +85	°C
Storage temperature	T_{stg}	-40 to +150	°C
Soldering temperature	T_{sol}	260(10s)	°C

*1 All are open except GND and applicable terminals.

*2 Pd: With infinite heat sink

*3 Overheat protection may operate at $T_j:125^{\circ}C$ to $150^{\circ}C$

■ Outline Dimensions

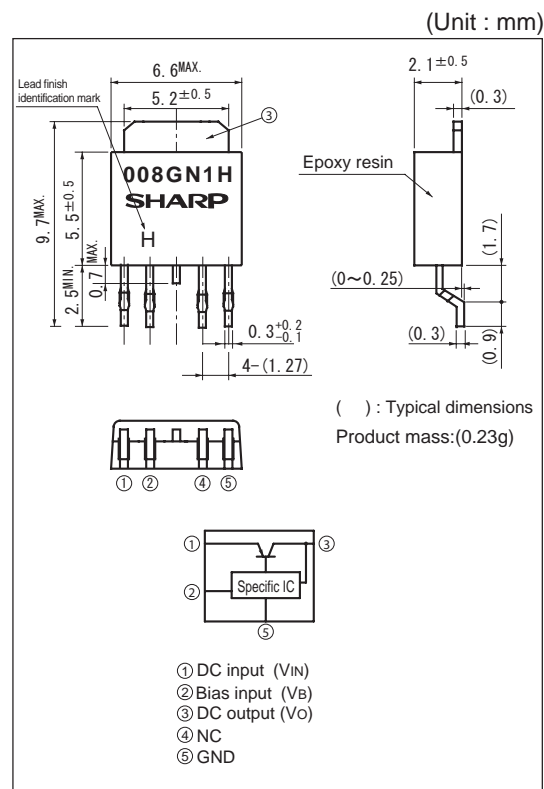

Lead finish: Lead-free solder plating
(Composition: Sn2Cu)

Notice The content of data sheet is subject to change without prior notice.

In the absence of confirmation by device specification sheets, SHARP takes no responsibility for any defects that may occur in equipment using any SHARP devices shown in catalogs, data books, etc. Contact SHARP in order to obtain the latest device specification sheets before using any SHARP device.

Electrical Characteristics

(Unless otherwise specified, condition shall be $V_{IN}=1.8V, V_B=3.3V, I_o=0.5A, T_a=25^\circ C$)

Parameter	Symbol	Conditions	MIN.	TYP.	MAX.	Unit
Input voltage	V_{IN}	-	1.7	-	5.5	V
Bias supply voltage	V_B	-	2.35	-	7	V
Output voltage	V_o	-	Refer to the following table.1			V
Load regulation	$RegL$	$I_o=5mA$ to 1.5A	-	0.3	1.0	%
Line regulation	$Regl$	$V_{IN}=1.7V$ to 5.5V, $V_B=2.35$ to 7V, $I_o=5mA$	-	0.3	1.0	%
Temperature coefficient of output voltage	$TcVo$	$T_j=0$ to $+125^\circ C$, $I_o=5mA$	-	± 0.5	-	%
Ripple rejection	RR1	Refer to Fig.2	-	60	-	dB
	RR2	Refer to Fig.3	-	53	-	dB
Bias inflow current	I_B	-	-	1.5	2	mA

Table.1 Output Voltage

(Unless otherwise specified, condition shall be $V_{IN}=1.8V, V_B=3.3V, I_o=0.5A, V_c=2.7V, T_a=25^\circ C$)

Model No.	Symbol	Conditions	MIN.	TYP.	MAX.	Unit
PQ008GN1HZPH	V_o	-	0.77	0.8	0.83	V
PQ010GN1HZPH			0.97	1	1.03	
PQ012GN1HZPH			1.07	1.2	1.23	

Fig.1 Test Circuit

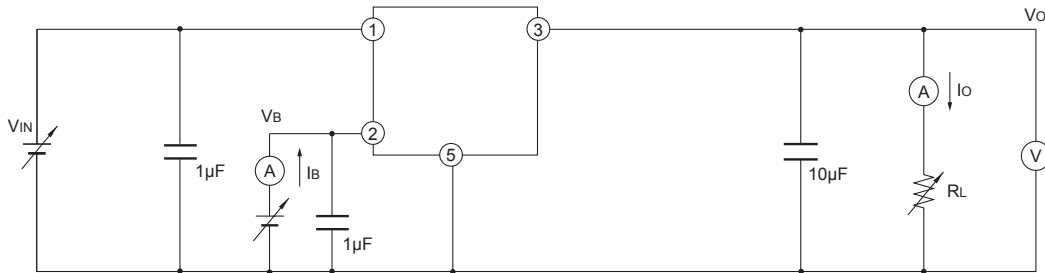
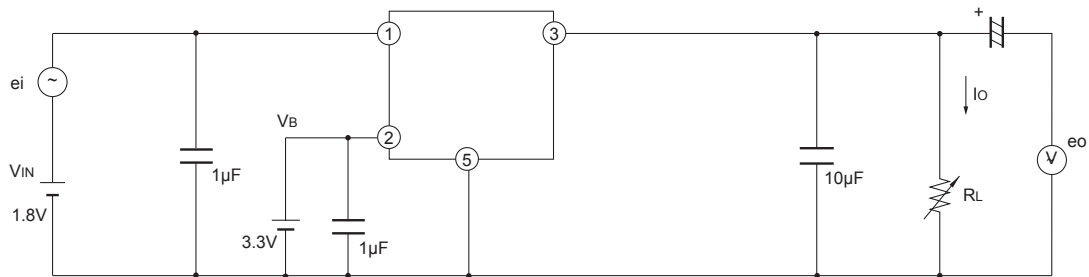

Fig.2 Test Circuit for Ripple Rejection (1)



$f=120Hz$ (sine wave)
 $e_i(rms)=0.1V$
 $V_{IN}=1.8V$
 $V_B=3.3V$
 $I_o=0.3A$
 $RR=20\log(e_i(rms)/e_o(rms))$

Fig.3 Test Circuit for Ripple Rejection (2)

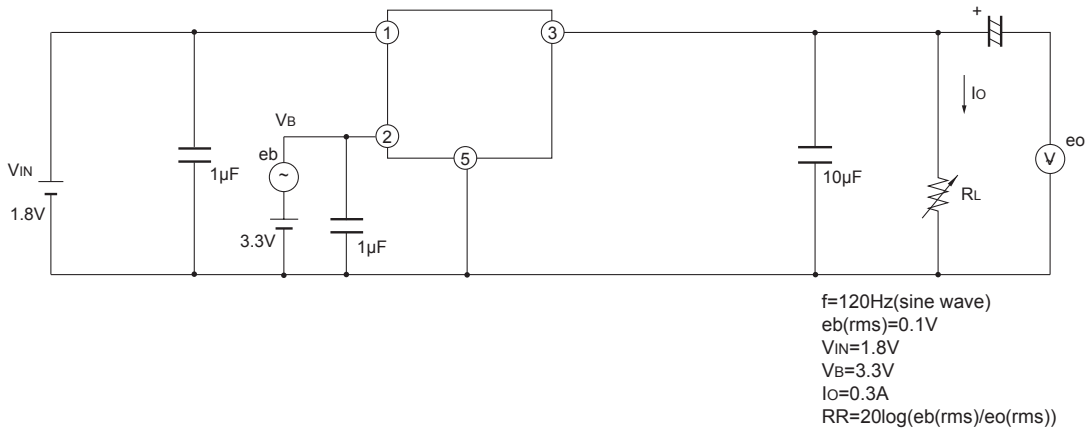
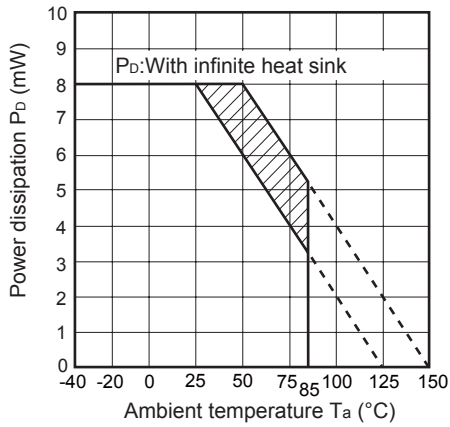

Fig.4 Power Dissipation vs. Ambient Temperature



Note) Oblique line portion: Overheat protection may operate in this area.

Fig.5 Overcurrent Protection Characteristics (PQ012GN1HZPH)

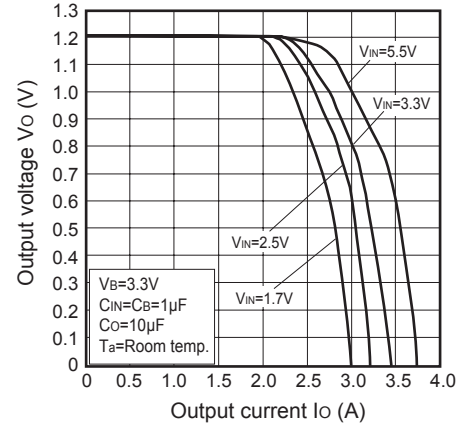

Fig.6 Output Voltage vs. Ambient Temperature (PQ008GN1HZPH)

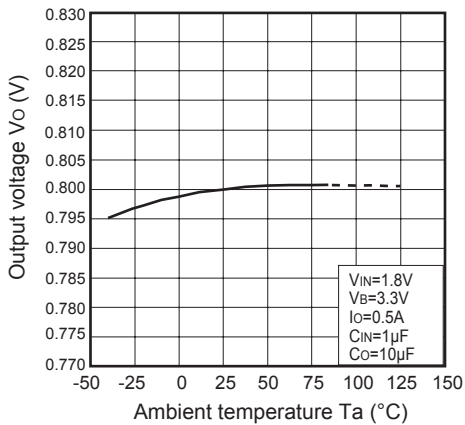

Fig.7 Output Voltage vs. Ambient Temperature (PQ010GN1HZPH)

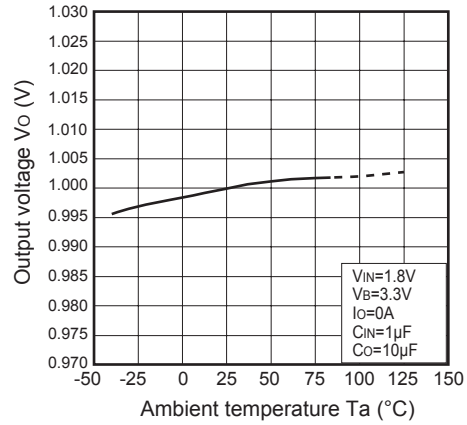

Fig.8 Output Voltage vs. Ambient Temperature (PQ012GN1HZPH)

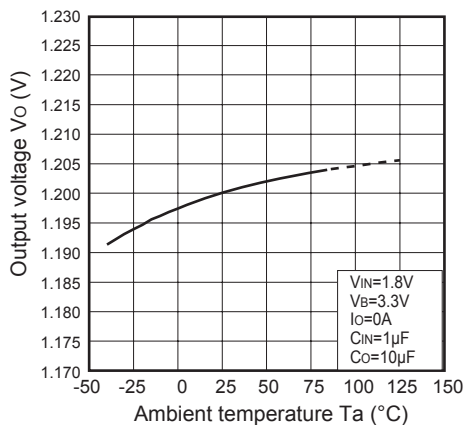

Fig.9 Line Regulation vs. Ambient Temperature

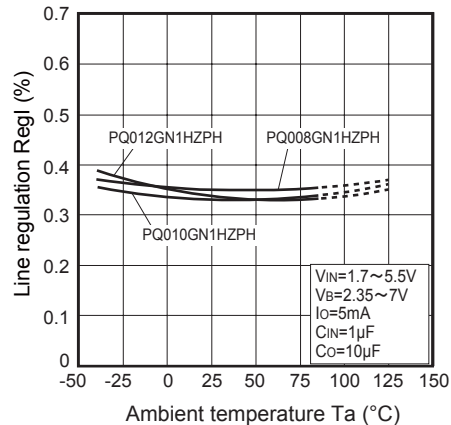

Fig.10 Bias Inflow Current vs. Ambient Temperature

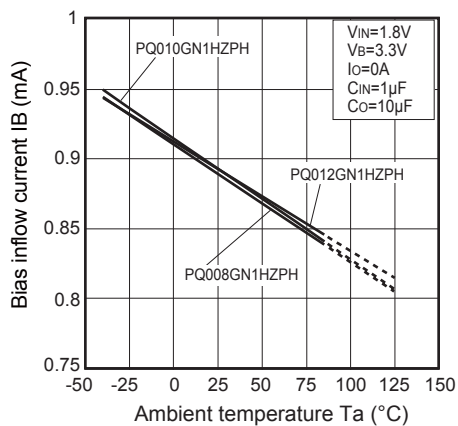

Fig.11 Output Voltage vs. Input Voltage (PQ008GN1HZPH)

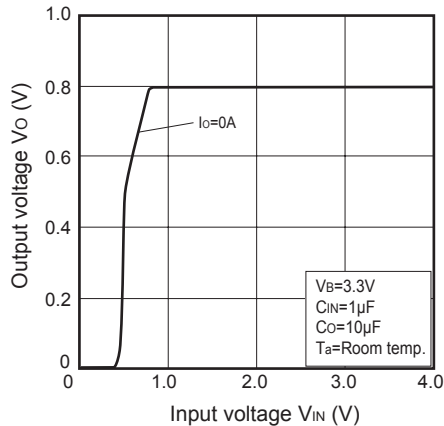

Fig.12 Output Voltage vs. Input Voltage (PQ010GN1HZPH)

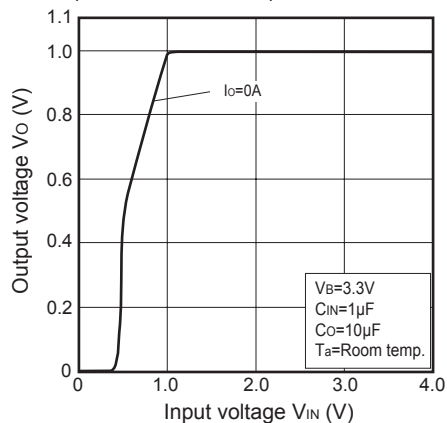

Fig.13 Output Voltage vs. Input Voltage (PQ012GN1HZPH)

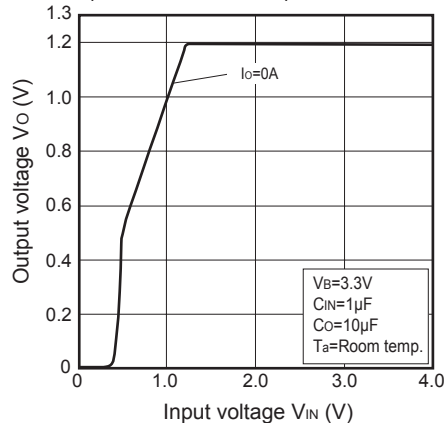

Fig.14 Output Voltage vs. Bias Supply Voltage (PQ008GN1HZPH)

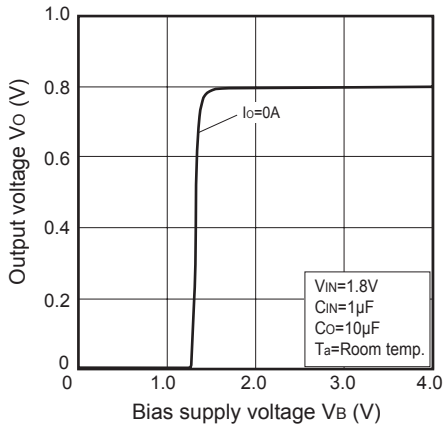

Fig.15 Output Voltage vs. Bias Supply Voltage (PQ010GN1HZPH)

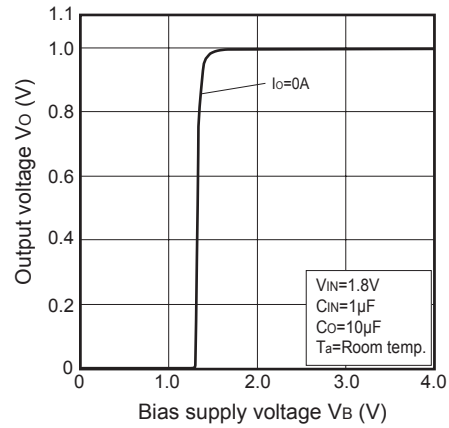

Fig.16 Output Voltage vs. Bias Supply Voltage (PQ012GN1HZPH)

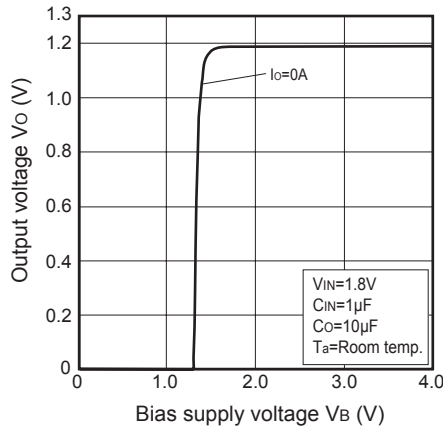

Fig.17 Output Voltage Deviation vs. Input Voltage / Bias Supply Voltage (PQ008GN1HZPH)

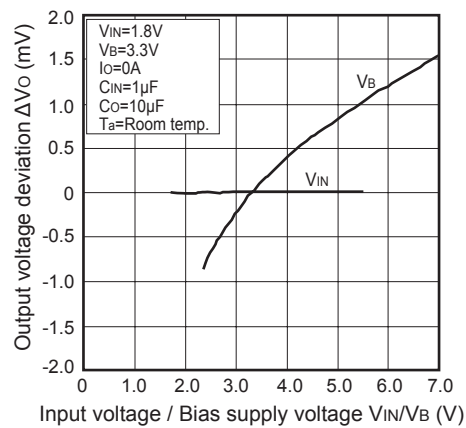

Fig.18 Output Voltage Deviation vs. Input Voltage / Bias Supply Voltage (PQ010GN1HZPH)

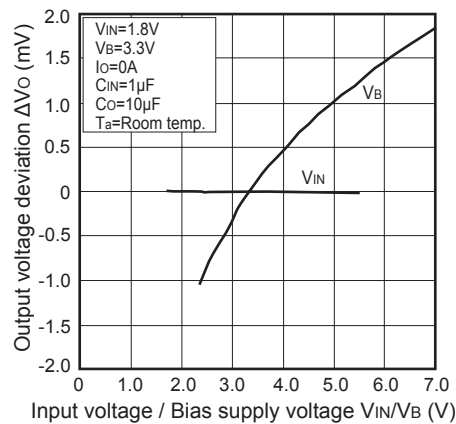

Fig.19 Output Voltage Deviation vs. Input Voltage / Bias Supply Voltage (PQ012GN1HZPH)

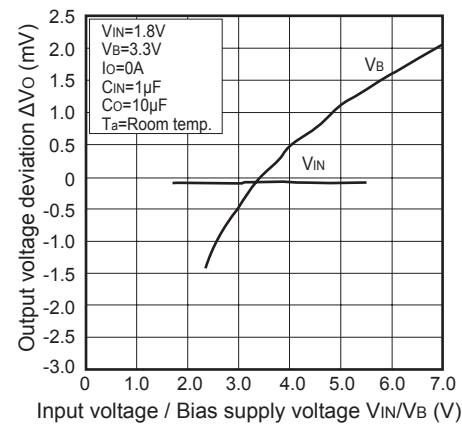

Fig.20 Input Current vs. Input Voltage (PQ008GN1HZPH)

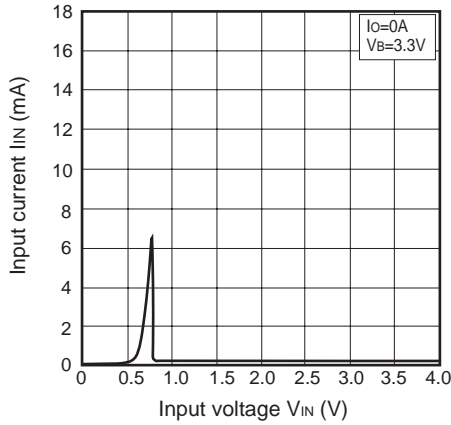

Fig.21 Input Current vs. Input Voltage (PQ010GN1HZPH)

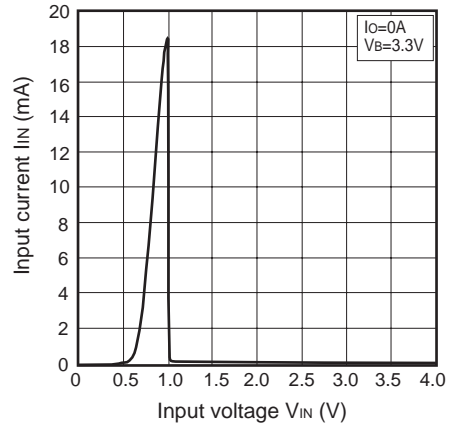

Fig.22 Input Current vs. Input Voltage (PQ012GN1HZPH)

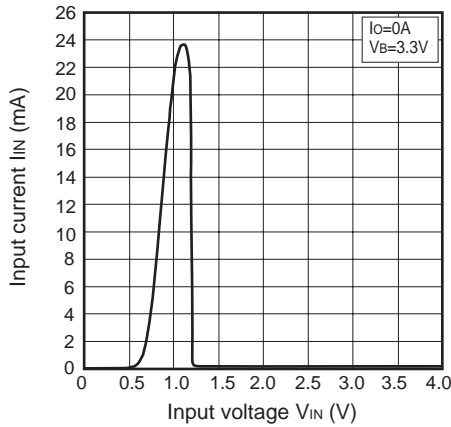

Fig.23 Bias Inflow Current vs. Input Voltage (PQ008GN1HZPH)

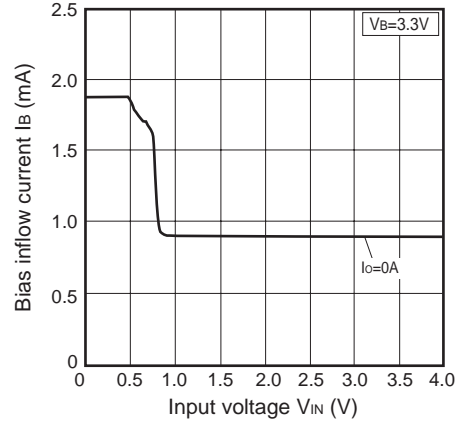

Fig.24 Bias Inflow Current vs. Input Voltage (PQ010GN1HZPH)

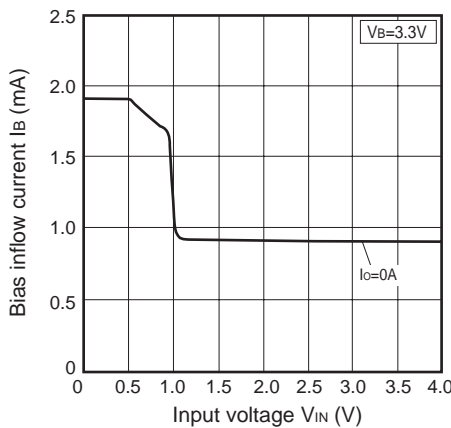

Fig.25 Bias Inflow Current vs. Input Voltage (PQ012GN1HZPH)

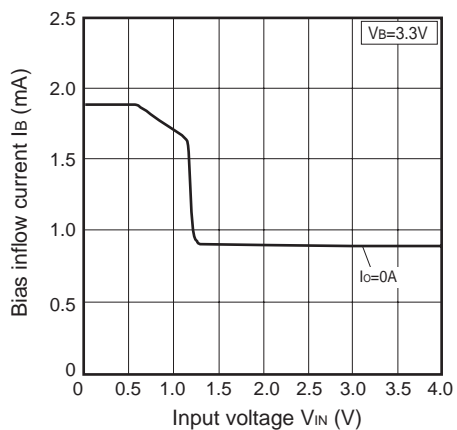

Fig.26 Bias Inflow Current vs. Bias Supply Voltage (PQ008GN1HZPH)

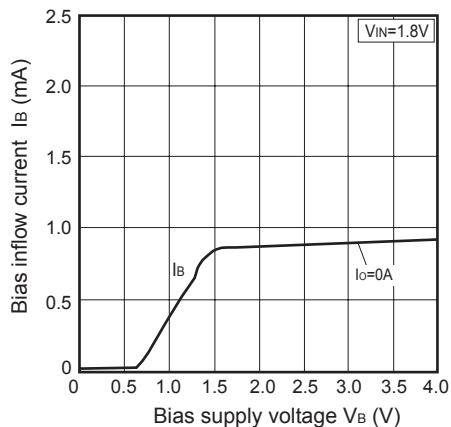

Fig.27 Bias Inflow Current vs. Bias Supply Voltage (PQ010GN1HZPH)

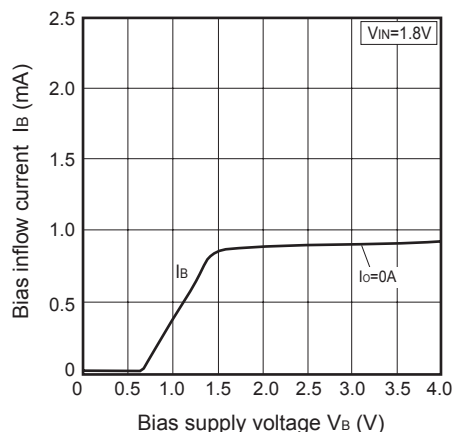

Fig.28 Bias Inflow Current vs. Bias Supply Voltage (PQ012GN1HZPH)

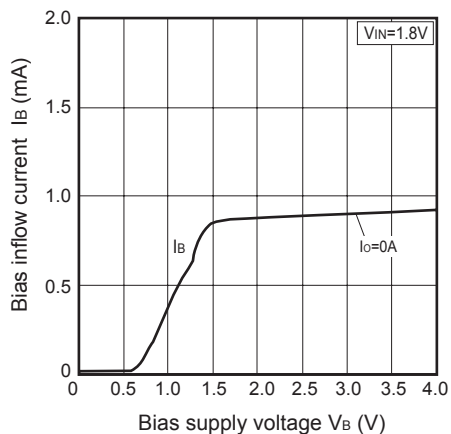
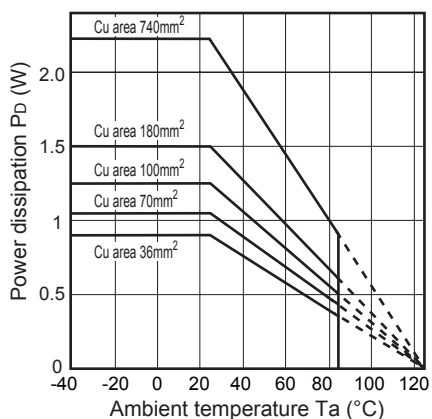
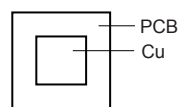

Fig.29 Power Dissipation vs. Ambient Temperature (Typical Value)



Mounting PCB



Material : Glass-cloth epoxy resin
 Size : 50×50×1.6mm
 Cu thickness : 35μm