

PQxxxFZ5MZ Series/PQxxxFZ01Z Series

Low Voltage Operation Low Power-Loss Voltage Regulators (SC-63)

Features

- Low voltage operation (Minimum operating voltage: 1.7V)
1.8V input → available 1.0 to 1.2V output
- Surface mount package (equivalent to EIAJ SC-63)

Applications

- Personal computers, power supply in peripherals
- Power supplies for various electronic equipment such as DVD player or STB

Model Line-up

Output current (I _o)	Package type	1.0V Output	1.2V Output
0.5A	Taping	PQ010FZ5MZP	PQ012FZ5MZP
	Sleeve	PQ010FZ5MZZ	PQ012FZ5MZZ
1A	Taping	PQ010FZ01ZP	PQ012FZ01ZP
	Sleeve	PQ010FZ01ZZ	PQ012FZ01ZZ

Absolute Maximum Ratings (Ta=25°C)

Parameter	Symbol	Rating	Unit
Input voltage	V _{IN}	3.7	V
Bias supply voltage	V _B	7	V
*1 Output Voltage	V _C	7	V
Output current	I _o	0.5	A
		1	
*2 Power dissipation	P _D	8	W
*3 Junction temperature	T _j	150	°C
Operating temperature	T _{opr}	-25 to +85	°C
Storage temperature	T _{stg}	-40 to +150	°C
Soldering temperature	T _{sol}	260(10s)	°C

*1 All are open except GND and applicable terminals.

*2 P_D:With infinite heat sink

*3 Overheat protection may operate at T_j=125°C to 150°C.

Outline Dimensions

(Unit : mm)

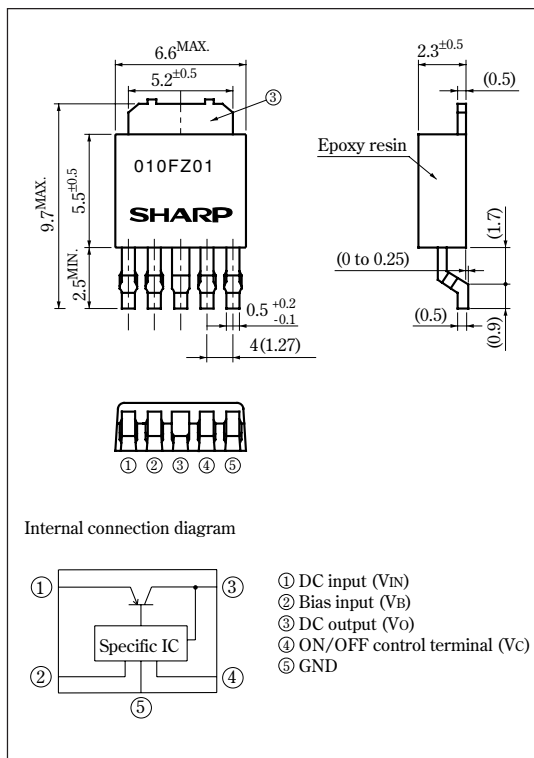

SHARP

•Please refer to the chapter " Handling Precautions ".

Electrical Characteristics (Unless otherwise specified, $V_{IN}=1.8V$, $V_B=3.3V$, $I_O=0.3A$, $V_C=2.7V$, $T_a=25^\circ C$ (PQxxxFZ5MZ))
 (Unless otherwise specified, $V_{IN}=1.8V$, $V_B=3.3V$, $I_O=0.5A$, $V_C=2.7V$, $T_a=25^\circ C$ (PQxxxFZ01Z))

Parameter	Symbol	Conditions	MIN.	TYP.	MAX.	Unit
Input voltage	V_{IN}	-	1.7	-	3.7	V
Bias supply voltage	V_B	-	2.35	-	7	V
Output voltage	V_O	-	Refer to following table			V
Load regulation	PQxxxFZ5MZ	$I_O=5mA$ to $0.5A$	-	0.2	1	%
	PQxxxFZ01Z					
Line regulation	$RegI$	$V_{IN}=1.7$ to $3.7V$, $V_B=2.35$ to $7V$, $I_O=5mA$	-	0.2	1	%
Temperature coefficient of output voltage	TcV_O	$T_j=0$ to $125^\circ C$, $I_O=5mA$	-	0.5	-	%/ $^\circ C$
Ripple rejection	RR1	Refer to Fig.2	-	65	-	dB
	RR2	Refer to Fig.3	-	60	-	dB
*4 ON-state voltage for control	$V_C(ON)$	-	-	-	-	V
ON-state current for control	$I_C(ON)$	-	2	-	200	μA
OFF-state voltage for control	$V_C(OFF)$	-	-	-	0.8	V
OFF-state current for control	$I_C(OFF)$	$V_C=0.4V$	-	-	2	μA
Bias inflow current	I_B	$I_O=0$	-	1.5	3	mA
Output OFF-state dissipation current	I_{qs}	$I_O=0$, $V_C=0.4V$	-	-	10	μA

*4 In case of opening control terminal ④, output voltage turns off

Output Voltage Line-up (Unless otherwise specified, $V_{IN}=1.8V$, $V_B=3.3V$, $I_O=0.3A$, $V_C=2.7V$, $T_a=25^\circ C$ (PQxxxFZ5MZ))
 (Unless otherwise specified, $V_{IN}=1.8V$, $V_B=3.3V$, $I_O=0.5A$, $V_C=2.7V$, $T_a=25^\circ C$ (PQxxxFZ01Z))

Model No.	Symbol	Conditions	MIN.	TYP.	MAX.	Unit
PQ010FZ5MZ/PQ010FZ01Z	V_O	-	0.97	1.0	1.03	V
PQ012FZ5MZ/PQ012FZ01Z	V_O	-	1.17	1.2	1.23	

Fig.1 Test Circuit

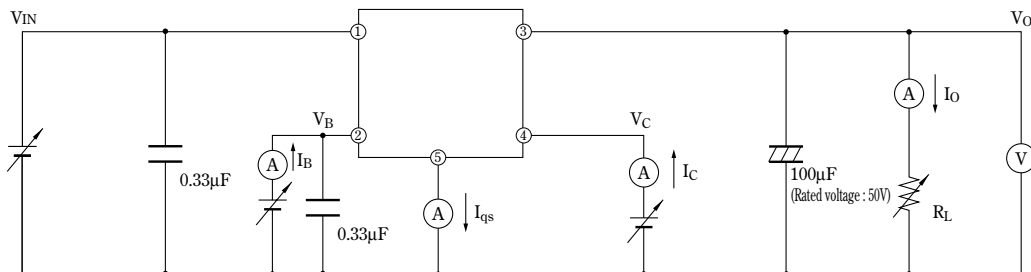

Fig.2 Test Circuit for Ripple Rejection

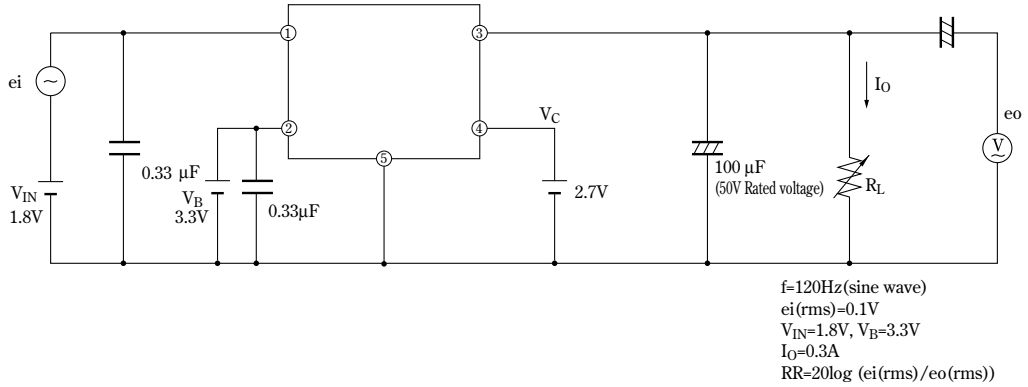

Fig.3 Test Circuit for Ripple Rejection

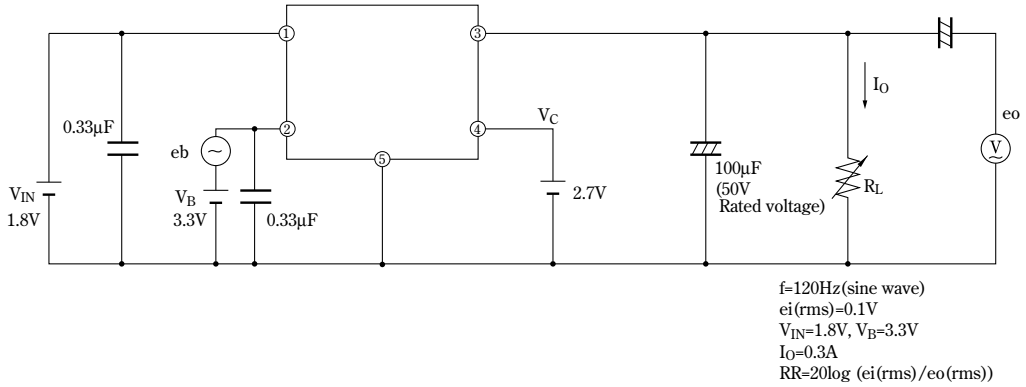

Fig.4 Power Dissipation vs. Ambient Temperature

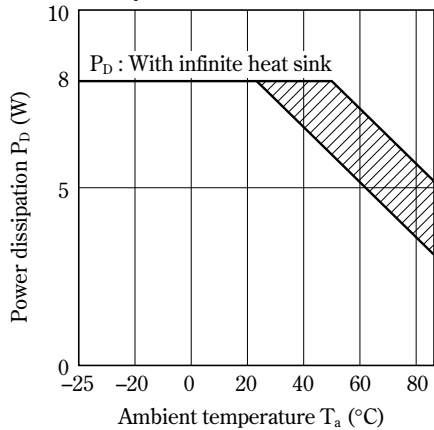

Fig.5 Overcurrent Protection Characteristics (PQ010FZ5MZ)

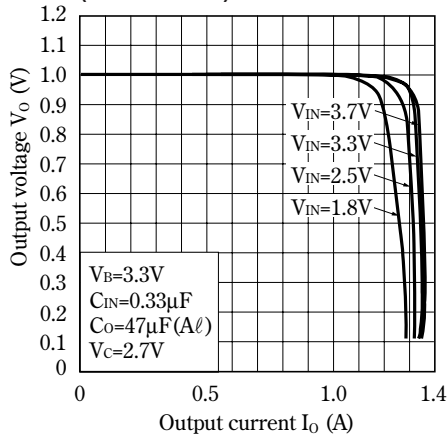

Fig.6 Overcurrent Protection Characteristics (PQ012FZ5MZ)

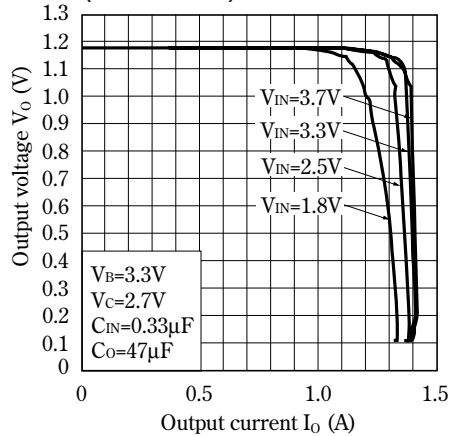

Fig.7 Overcurrent Protection Characteristics (PQ010FZ01Z)

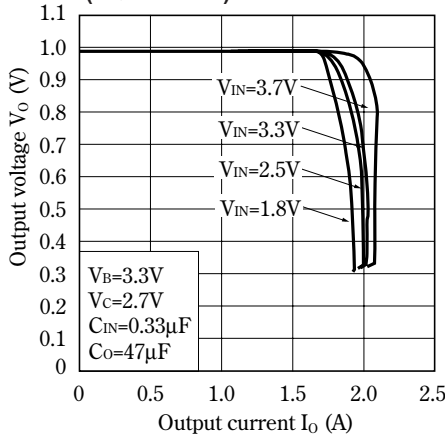

Fig.8 Overcurrent Protection Characteristics (PQ012FZ01Z)

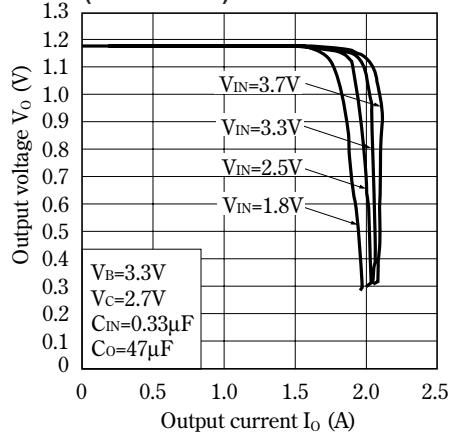

Fig.9 Output Voltage vs. Ambient Temperature (PQ010FZ5MZ / PQ010FZ01Z)

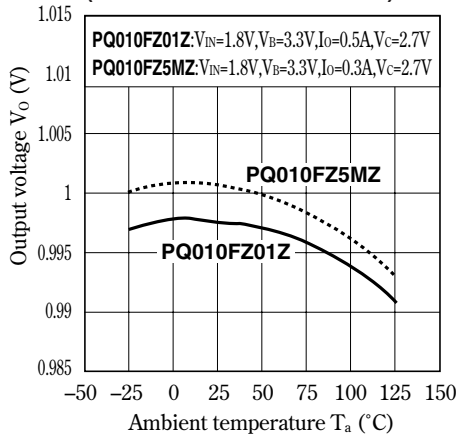

Fig.10 Output Voltage vs. Ambient Temperature (PQ012FZ5MZ / PQ012FZ01Z)

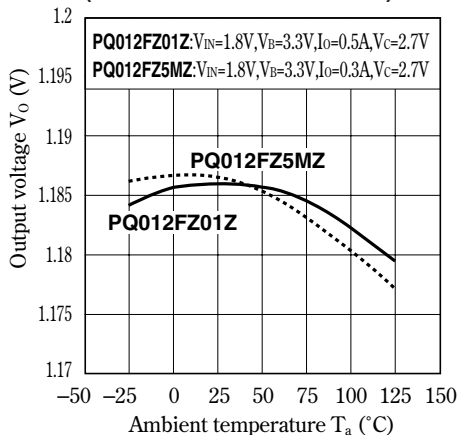

Fig.11 Bias Inflow Current vs. Ambient Temperature

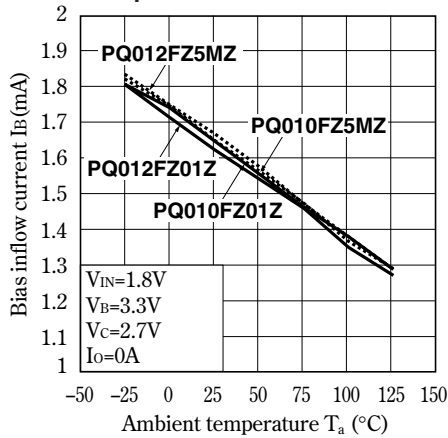

Fig.12 Output Short-circuit Current vs. Ambient Temperature (Reference)

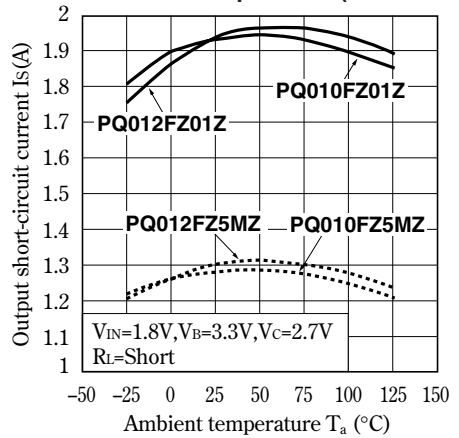

Fig.13 Output Voltage vs. Input Voltage (PQ010FZ5MZ)

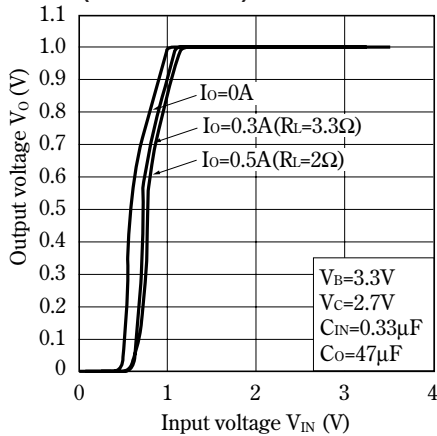

Fig.14 Output Voltage vs. Input Voltage (PQ012FZ5MZ)

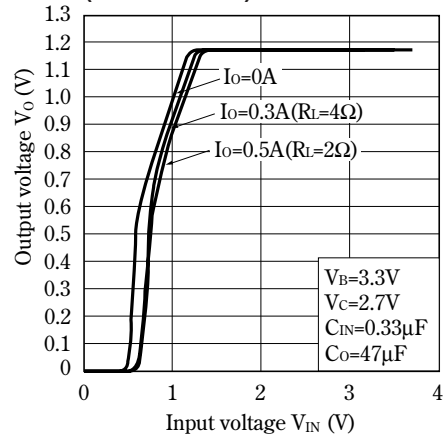

Fig.15 Output Voltage vs. Input Voltage (PQ010FZ01Z)

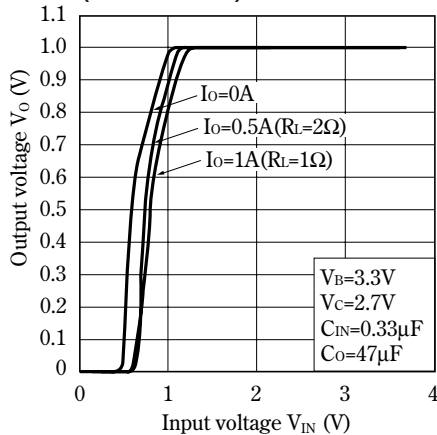

Fig.16 Output Voltage vs. Input Voltage (PQ012FZ01Z)

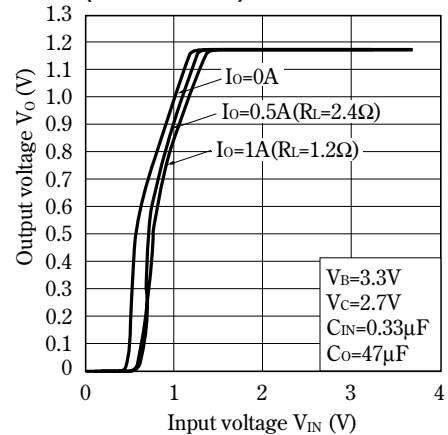

Fig.17 Output Voltage vs. Bias Supply Voltage (PQ010FZ5MZ)

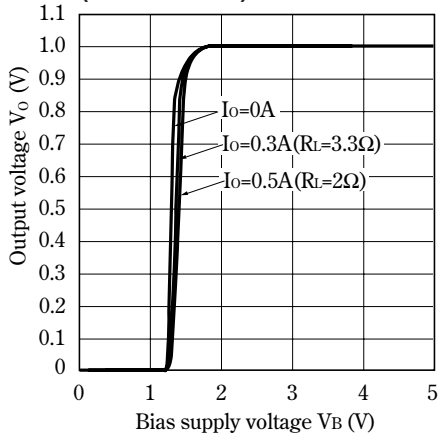

Fig.18 Output Voltage vs. Bias Supply Voltage (PQ012FZ5MZ)

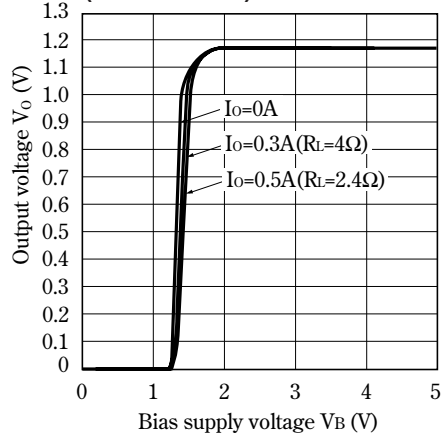

Fig.19 Output Voltage vs. Bias Supply Voltage (PQ010FZ01Z)

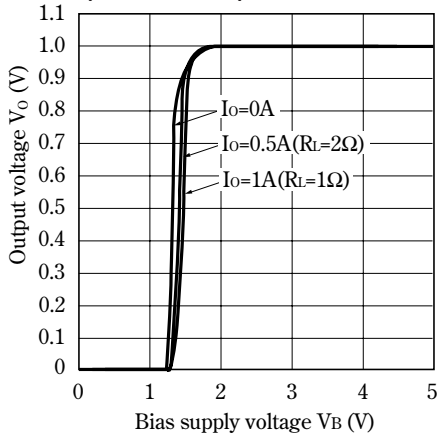

Fig.20 Output Voltage vs. Bias Supply Voltage (PQ012FZ01Z)

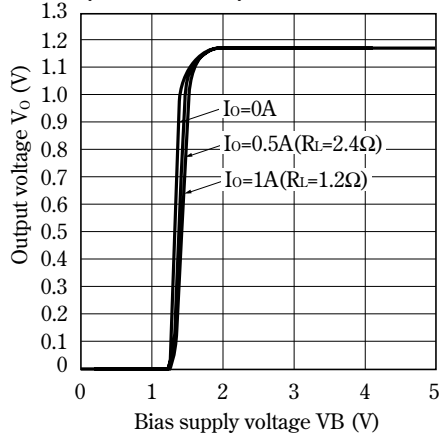

Fig.21 Circuit Operating Current vs. Input Voltage /Bias Supply Voltage (PQ010FZ5MZ)

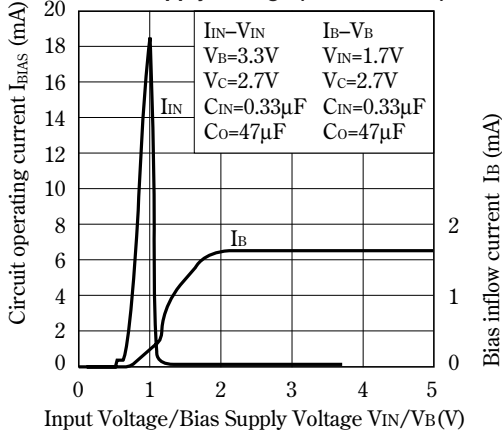

Fig.22 Circuit Operating Current vs. Input Voltage /Bias Supply Voltage (PQ012FZ5MZ)

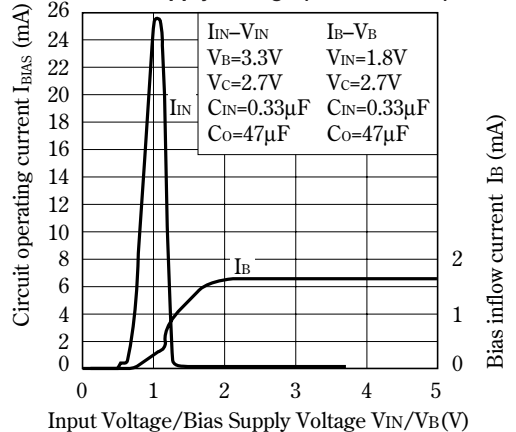

Fig.23 Circuit Operating Current vs. Input Voltage /Bias Supply Voltage (PQ010FZ01Z)

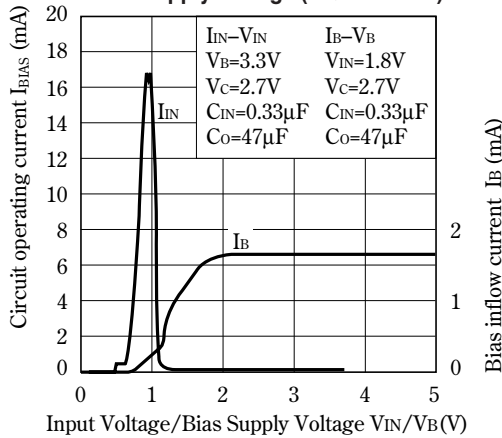

Fig.24 Circuit Operating Current vs. Input Voltage /Bias Supply Voltage (PQ012FZ01Z)

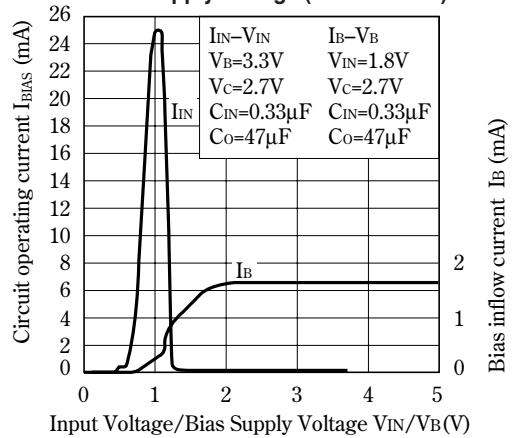

Fig.25 Output Voltage vs. Input Voltage / Bias Supply Voltage (PQ010FZ5MZ)

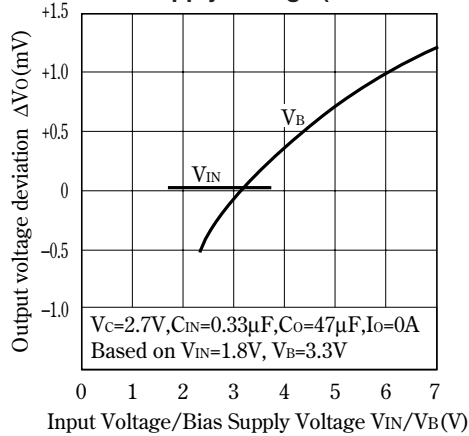

Fig.26 Output Voltage vs. Input Voltage / Bias Supply Voltage (PQ010FZ01Z)

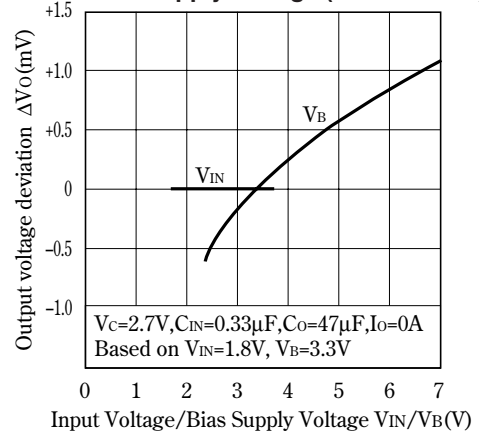

Fig.27 Output Voltage vs. Input Voltage / Bias Supply Voltage (PQ012FZ5MZ)

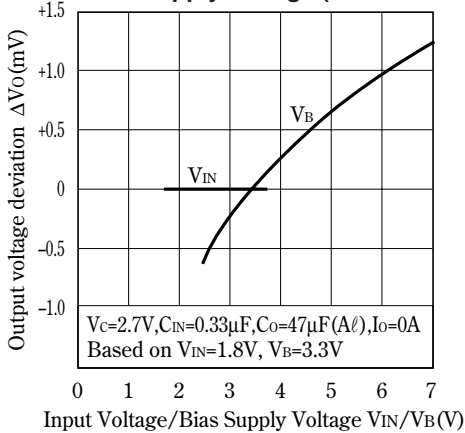

Fig.28 Output Voltage vs. Input Voltage / Bias Supply Voltage (PQ012FZ01Z)

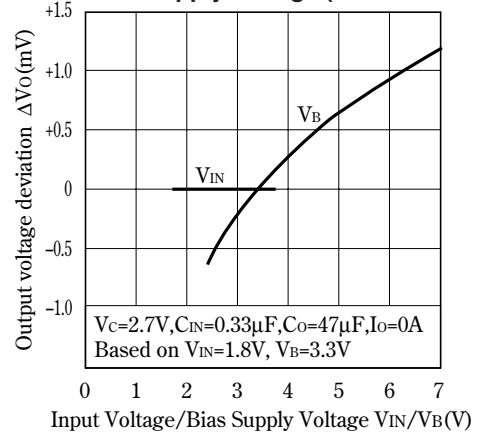

Fig.29 Output Voltage vs. Output Current

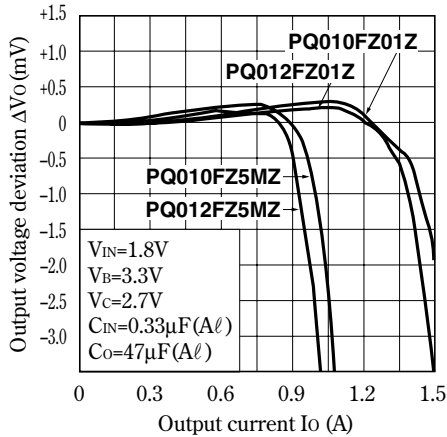

Fig.30 Ripple Rejection vs. Input Ripple Frequency(PQ010FZ5MZ/PQ010FZ01Z)

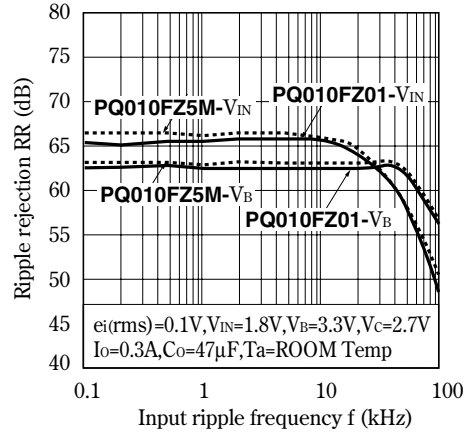

Fig.31 Ripple Rejection vs. Input Ripple Frequency(PQ012FZ5MZ/PQ012FZ01Z)

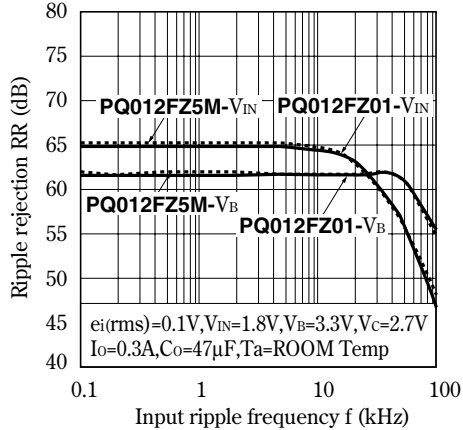

Fig.32 Ripple Rejection vs. Output Current (PQ010FZ5MZ / PQ010FZ01Z)

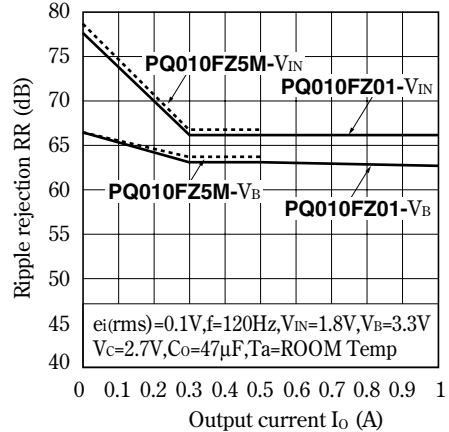

Fig.33 Ripple Rejection vs. Output Current (PQ010FZ5MZ / PQ010FZ01Z)

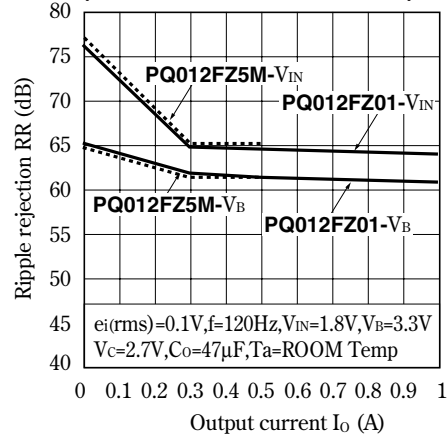

Fig.34 Typical Application

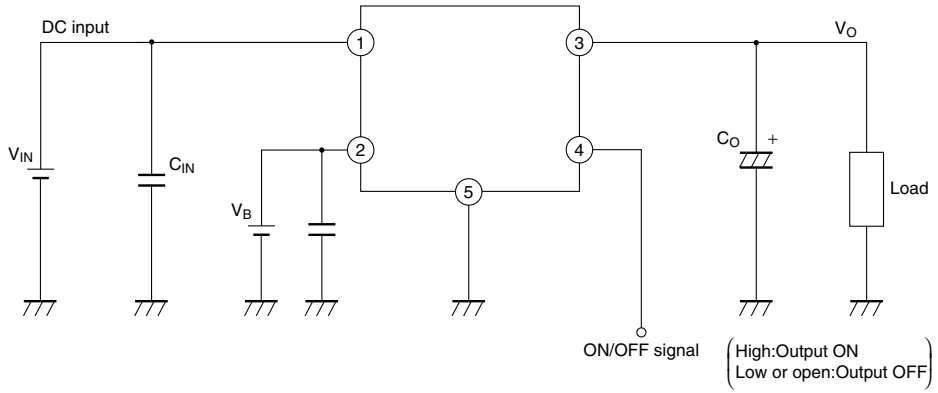
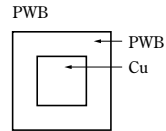
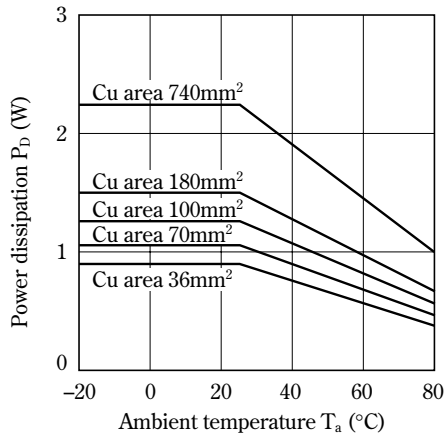

Fig.35 Power Dissipation vs. Ambient Temperature (Typical Value)



Material : Glass-cloth epoxy resin
 Size : 50×50×1.6mm
 Cu thickness : 35μm

NOTICE

- The circuit application examples in this publication are provided to explain representative applications of SHARP devices and are not intended to guarantee any circuit design or license any intellectual property rights. SHARP takes no responsibility for any problems related to any intellectual property right of a third party resulting from the use of SHARP's devices.
- Contact SHARP in order to obtain the latest device specification sheets before using any SHARP device. SHARP reserves the right to make changes in the specifications, characteristics, data, materials, structure, and other contents described herein at any time without notice in order to improve design or reliability. Manufacturing locations are also subject to change without notice.
- Observe the following points when using any devices in this publication. SHARP takes no responsibility for damage caused by improper use of the devices which does not meet the conditions and absolute maximum ratings to be used specified in the relevant specification sheet nor meet the following conditions:
 - (i) The devices in this publication are designed for use in general electronic equipment designs such as:
 - Personal computers
 - Office automation equipment
 - Telecommunication equipment [terminal]
 - Test and measurement equipment
 - Industrial control
 - Audio visual equipment
 - Consumer electronics
 - (ii) Measures such as fail-safe function and redundant design should be taken to ensure reliability and safety when SHARP devices are used for or in connection with equipment that requires higher reliability such as:
 - Transportation control and safety equipment (i.e., aircraft, trains, automobiles, etc.)
 - Traffic signals
 - Gas leakage sensor breakers
 - Alarm equipment
 - Various safety devices, etc.
 - (iii) SHARP devices shall not be used for or in connection with equipment that requires an extremely high level of reliability and safety such as:
 - Space applications
 - Telecommunication equipment [trunk lines]
 - Nuclear power control equipment
 - Medical and other life support equipment (e.g., scuba).
- If the SHARP devices listed in this publication fall within the scope of strategic products described in the Foreign Exchange and Foreign Trade Law of Japan, it is necessary to obtain approval to export such SHARP devices.
- This publication is the proprietary product of SHARP and is copyrighted, with all rights reserved. Under the copyright laws, no part of this publication may be reproduced or transmitted in any form or by any means, electronic or mechanical, for any purpose, in whole or in part, without the express written permission of SHARP. Express written permission is also required before any use of this publication may be made by a third party.
- Contact and consult with a SHARP representative if there are any questions about the contents of this publication.