

PQxxxENA1ZPH Series

Low Voltage Operation, Compact Surface Mount type Low Power-Loss Voltage Regulators

Features

1. Low voltage operation
(Minimum operating voltage: 2.35V)
2. Output current : 1A
3. Low dissipation current
(Dissipation current at no load: MAX. 2mA
Output OFF-state dissipation current: MAX. 5 μ A)
4. Compliant Ceramic capacitors
5. Built-in ON/OFF function
6. Built-in overcurrent and overheat protection functions
7. Conform to Flow Soldering SC-63 package
8. RoHS directive compliant

Applications

1. Personal computers and peripheral equipment
2. Power supplies for various digital electronic equipment such as DVD player or STB

Model Line-up

Output Voltage (TYP.)	Model No.
1.5V	PQ015ENA1ZPH
1.8V	PQ018ENA1ZPH
2.5V	PQ025ENA1ZPH
3.3V	PQ033ENA1ZPH

Absolute Maximum Ratings

(Ta=25°C)

Parameter	Symbol	Rating	Unit
*1 Input voltage	V _{IN}	10	V
*1 Output control voltage	V _C	10	V
Output current	I _O	1	A
*2 Power dissipation	P _D	8	W
*3 Junction temperature	T _J	150	°C
Operating temperature	T _{opr}	-40 to +85	°C
Storage temperature	T _{stg}	-40 to +150	°C
Soldering temperature	T _{sol}	260(10s)	°C

*1 All are open except GND and applicable terminals.

*2 At surface-mounted condition

*3 Overheat protection may operate at T_J:125°C to 150°C

Outline Dimensions

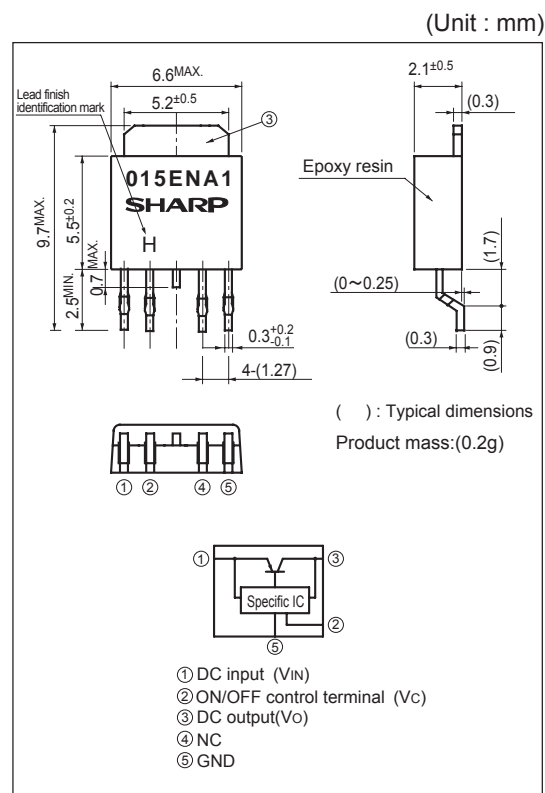

Notice The content of data sheet is subject to change without prior notice.

In the absence of confirmation by device specification sheets, SHARP takes no responsibility for any defects that may occur in equipment using any SHARP devices shown in catalogs, data books, etc. Contact SHARP in order to obtain the latest device specification sheets before using any SHARP device.

Electrical Characteristics

(Unless otherwise specified, condition shall be $V_{IN}=V_O(TYP.)+1V, I_O=0.5A, V_C=2.7V, T_a=25^\circ C$)

Parameter	Symbol	Conditions	MIN.	TYP.	MAX.	Unit
Input voltage	V_{IN}	-	Refer to the following table.1			V
Output voltage	V_O	-	Refer to the following table.2			V
Load regulation	RegL	$I_O=5mA$ to 1.0A	-	0.2	1.0	%
Line regulation	Regl	$V_{IN}=V_O(TYP.)+1V$ to $V_O(TYP.)+6V, I_O=5mA$	-	0.1	1.0	%
Temperature coefficient of output voltage	$T_C V_O$	$T_j=0$ to $+125^\circ C, I_O=5mA$	-	± 0.01	-	%/ $^\circ C$
Ripple rejection	RR	Refer to Fig.3	-	60	-	dB
*4 Dropout voltage	V_{I-O}	$I_O=0.5A$ *5	-	0.2	0.5	V
*6 ON-state voltage for control	$V_{C(ON)}$	-	2.0	-	-	V
ON-state current for control	$I_{C(ON)}$	-	-	-	200	μA
OFF-state voltage for control	$V_{C(OFF)}$	-	-	-	0.6	V
OFF-state current for control	$I_{C(OFF)}$	$V_C=0.4V$	-	-	5	μA
Quiescent current	I_q	$I_O=0A$	-	1	2	mA
Output OFF-state dissipation current	I_{qs}	$I_O=0A, V_C=0.4V$	-	-	5	μA

*4 Applied to PQ033ENA1ZPH

*5 Input voltage shall be the value when output voltage is 95% in comparison with the initial value.

*6 In case of opening control terminal ②, output voltage turns off

Table.1 Input Voltage range

(Unless otherwise specified, condition shall be $I_O=0.5A, V_C=2.7V, T_a=25^\circ C$)

Model No.	Symbol	Conditions	MIN.	TYP.	MAX.	Unit
PQ015ENA1ZPH	V_{IN}	-	2.35	-	10	V
PQ018ENA1ZPH	V_{IN}	-	2.35	-	10	V
PQ025ENA1ZPH	V_{IN}	-	3.0	-	10	V
PQ033ENA1ZPH	V_{IN}	-	3.8	-	10	V

Table.2 Output Voltage

(Unless otherwise specified, condition shall be $V_{IN}=V_O(TYP.)+1V, I_O=0.5A, V_C=2.7V, T_a=25^\circ C$)

Model No.	Symbol	Conditions	MIN.	TYP.	MAX.	Unit
PQ015ENA1ZPH	V_O	-	1.47	1.5	1.53	V
PQ018ENA1ZPH	V_O	-	1.764	1.8	1.836	V
PQ025ENA1ZPH	V_O	-	2.45	2.5	2.55	V
PQ033ENA1ZPH	V_O	-	3.234	3.3	3.366	V

Fig.1 Typical Application

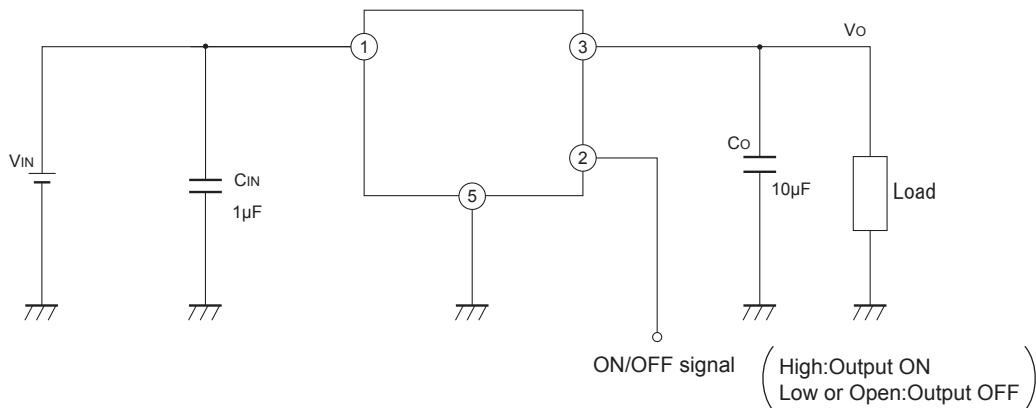

Fig.2 Test Circuit

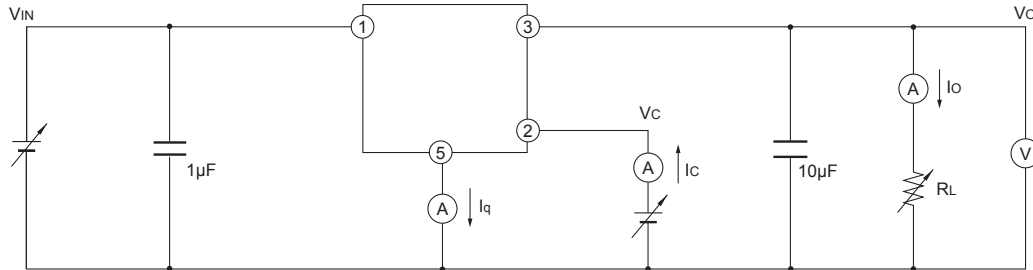
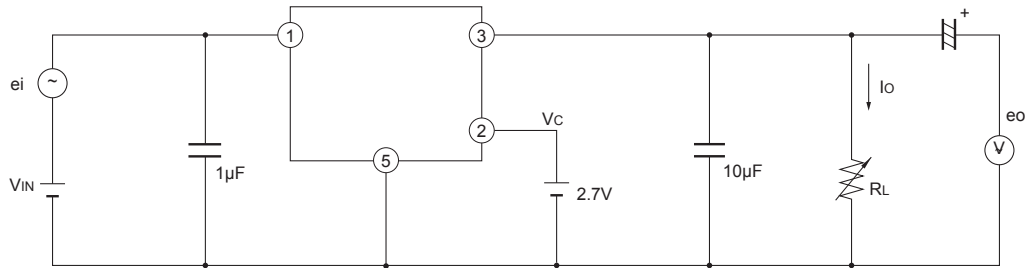
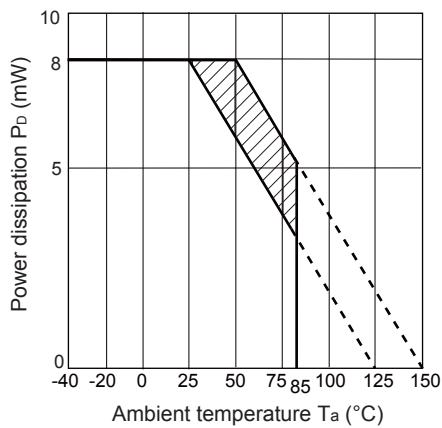

Fig.3 Test Circuit for Ripple Rejection



$f=120\text{Hz}(\text{sine wave})$
 $e_i(\text{rms})=0.5\text{V}$
 $V_{IN}=V_o(\text{TYP})+2\text{V}$
 $I_o=0.3\text{A}$
 $RR=20\log(e_i(\text{rms})/e_o(\text{rms}))$

Fig.4 Power Dissipation vs. Ambient Temperature



Note) Oblique line portion: Overheat protection may operate in this area.

Fig.5 Overcurrent Protection Characteristics (PQ015ENA1ZPH)

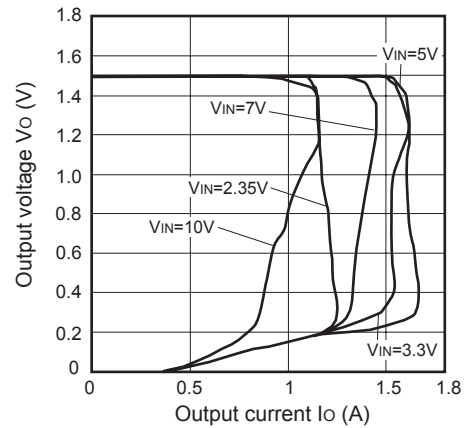

Fig.6 Overcurrent Protection Characteristics (PQ018ENA1ZPH)

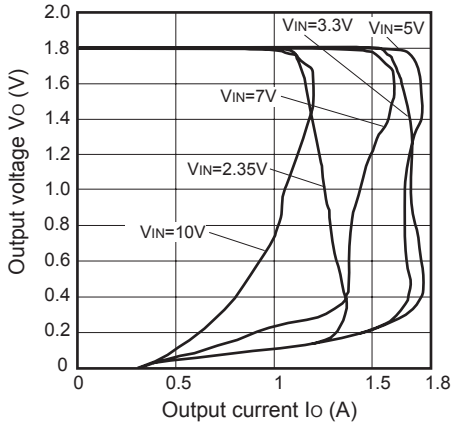

Fig.7 Overcurrent Protection Characteristics (PQ025ENA1ZPH)

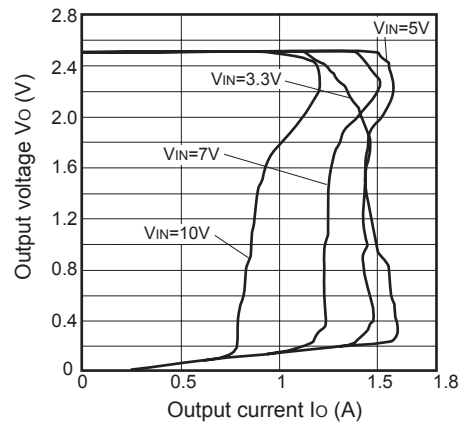

Fig.8 Overcurrent Protection Characteristics (PQ033ENA1ZPH)

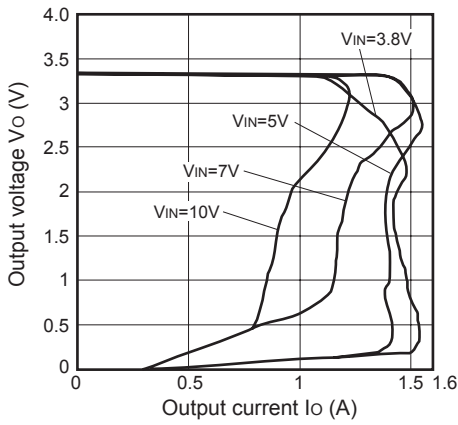

Fig.9 Output Voltage vs. Ambient Temperature (PQ025ENA1ZPH)

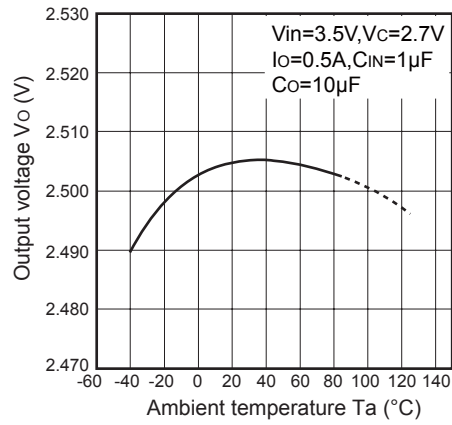

Fig.10 Output Voltage vs. Ambient Temperature (PQ033ENA1ZPH)

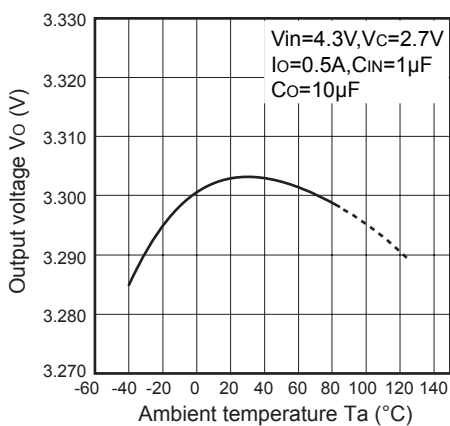

Fig.11 Dropout Voltage vs. Ambient Temperature (PQ025ENA1ZPH, PQ033ENA1ZPH)

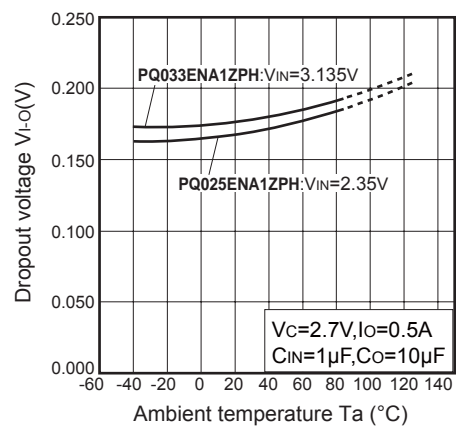

Fig.12 Line Regulation vs. Ambient Temperature

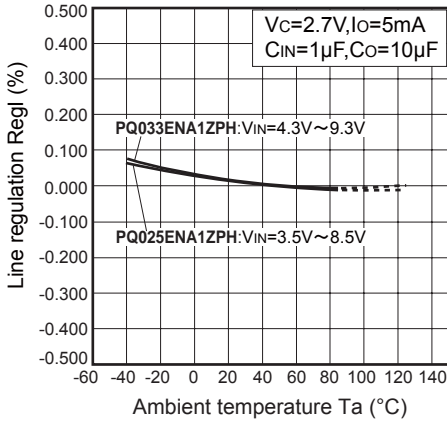

Fig.13 Load Regulation vs. Ambient Temperature

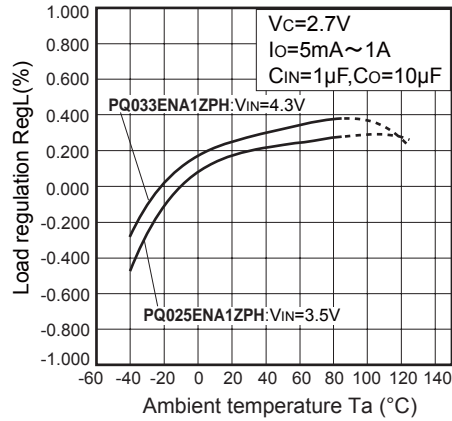

Fig.14 Quiescent Current vs. Ambient Temperature (PQxxxENA1ZPH)

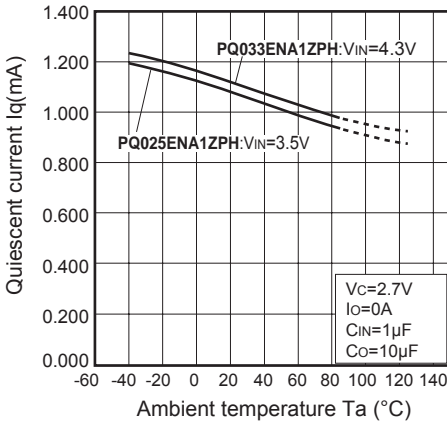

Fig.15 Output Voltage vs. ON/OFF Control Voltage (PQ033ENA1ZPH)

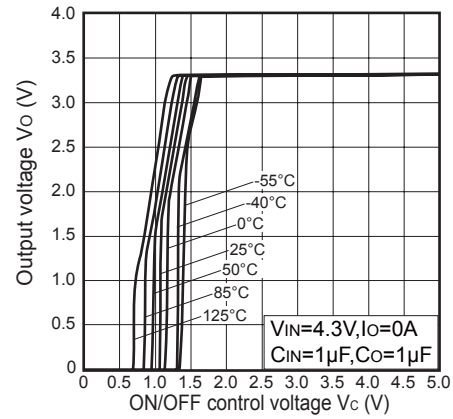

Fig.16 Output Voltage Deviation vs. Input Voltage (PQ025ENA1ZPH)

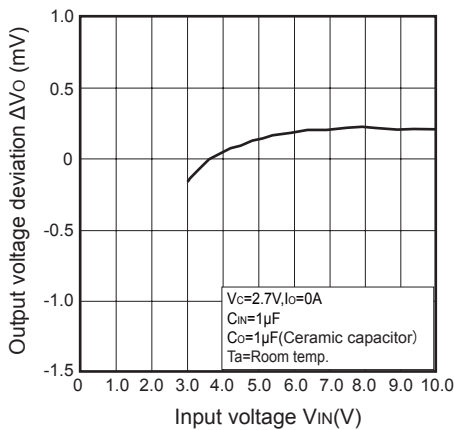

Fig.17 Output Voltage Deviation vs. Input Voltage (PQ033ENA1ZPH)

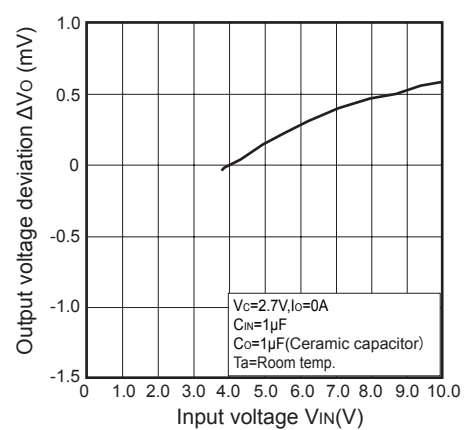

Fig.18 Output Voltage Deviation vs. Output Current

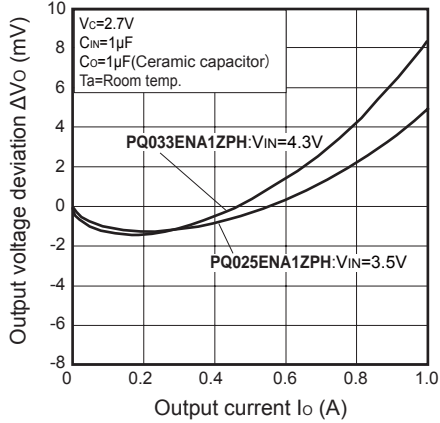

Fig.19 Output Voltage vs. Input Voltage (PQ025ENA1ZPH)

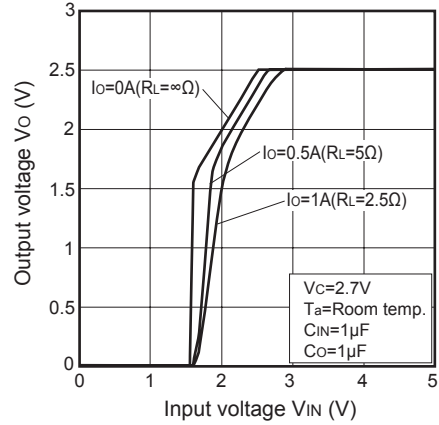

Fig.20 Output Voltage vs. Input Voltage (PQ033ENA1ZPH)

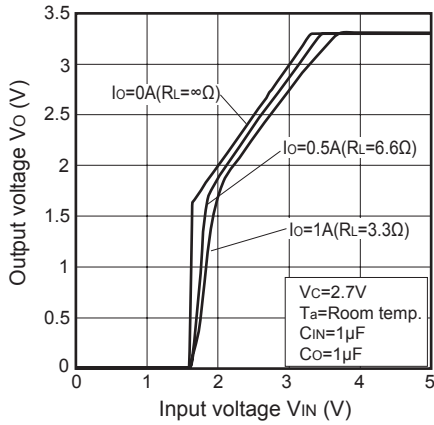

Fig.21 Circuit Operating Current vs. Input Voltage (PQ025ENA1ZPH)

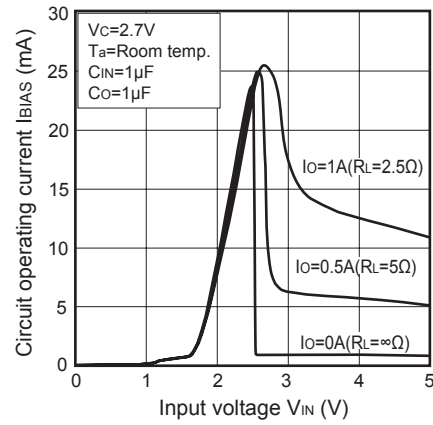

Fig.22 Circuit Operating Current vs. Input Voltage (PQ033ENA1ZPH)

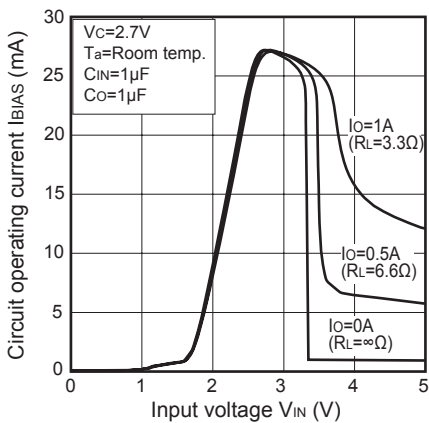

Fig.23 Dropout Voltage vs. Output Current (PQ025ENA1ZPH)

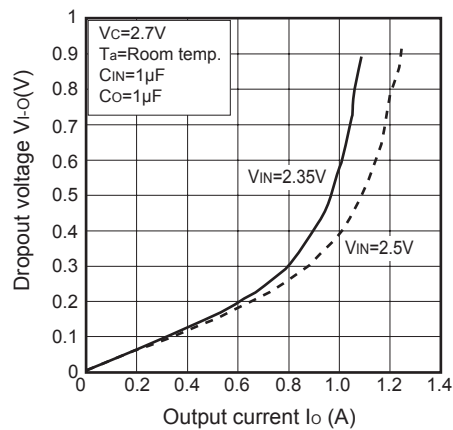

Fig.24 Dropout Voltage vs. Output Current (PQ033ENA1ZPH)

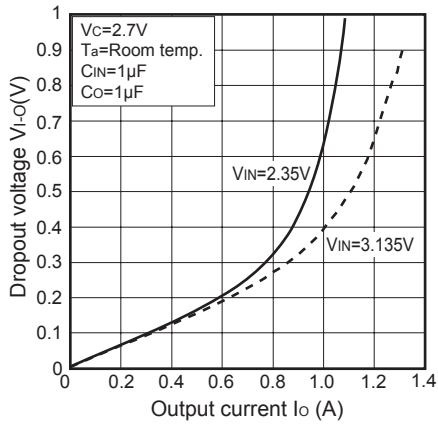

Fig.25 Ripple Rejection vs. Input Ripple Frequency (PQxxxENA1ZPH)

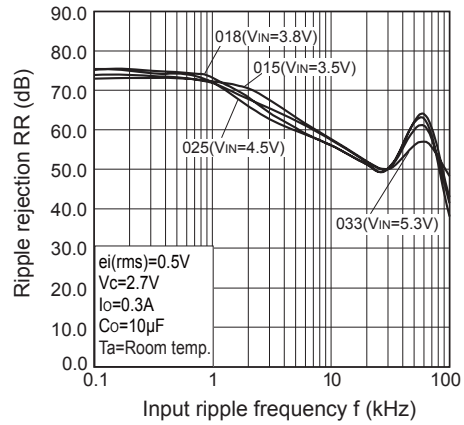

Fig.26 Ripple Rejection vs. Output Current (PQxxxENA1ZPH)

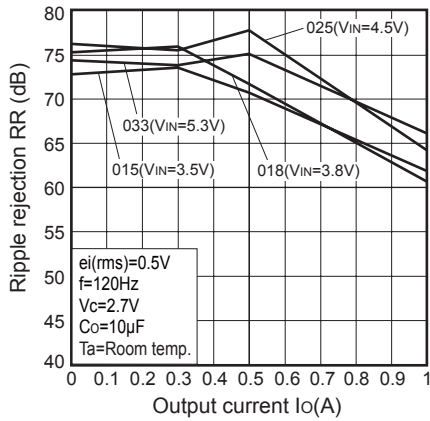
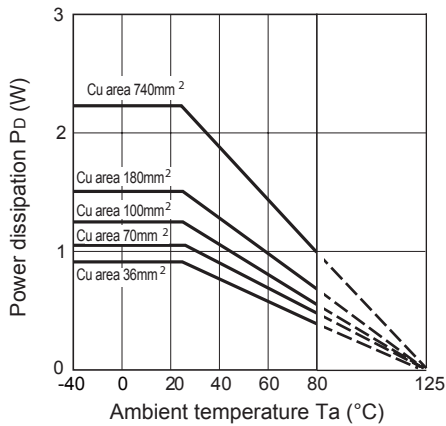
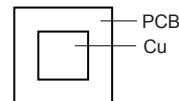

Fig.27 Power Dissipation vs. Ambient Temperature (Typical Value)



Mounting PCB



Material : Glass-cloth epoxy resin
 Size : $50 \times 50 \times 1.6mm$
 Cu thickness : $35\mu m$