

PQ05RG1/PQ05RG11 Series

Low Power-Loss Voltage Regulators(Built-in Reverse Voltage Protection Function
Between Input and Output)

■ Features

- Low power-loss (Dropout voltage : MAX. 0.5V)
- Compact resin full-mold package
- Built-in a function to prevent reverse voltage between input and output
The diode to prevent reverse voltage between input and output is not necessary. ($V_{O-i} < 15V$)
- Built-in ON/OFF control function

■ Applications

- Series power supply for various electronic equipment such as VCRs and musical instruments

■ Model Line-ups

Output voltage	5V output	9V output	12V output
Output voltage precision:±5%	PQ05RG1	PQ09RG1	PQ12RG1
Output voltage precision:±2.5%	PQ05RG11	PQ09RG11	PQ12RG11

■ Outline Dimensions

(Unit : mm)

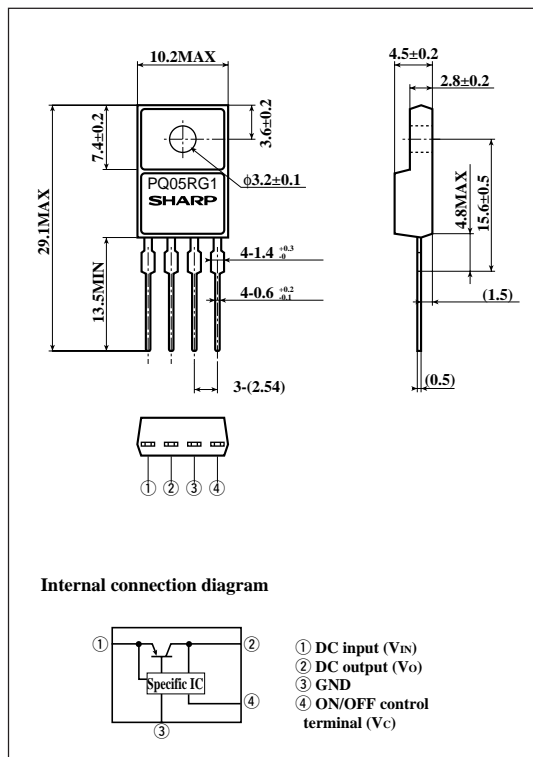

■ Absolute Maximum Ratings

(T_a=25°C)

Parameter	Symbol	Rating	Unit
*1 Input voltage	V_{IN}	35	V
*1 ON/OFF control terminal voltage	V_C	35	V
*2 Input-output reverse voltage	V_{O-i}	15	V
Output current	I_O	1.0	A
Power dissipation(No heat sink)	P_{D1}	1.5	W
Power dissipation (With infinite heat sink)	P_{D2}	15	
*3 Junction temperature	T_j	150	°C
Operating temperature	T_{opr}	-20 to +80	°C
Storage temperature	T_{stg}	-40 to +150	°C
Soldering temperature	T_{sol}	260 (For 10s)	°C

*1 All are open except GND and applicable terminals.

*2 V_O terminal applicable voltage from external: V_O (characteristics value) to 25V

*3 Overheat protection may operate at $125 < T_j < 150$ °C

· Please refer to the chapter "Handling Precautions".

SHARP

" In the absence of confirmation by device specification sheets, SHARP takes no responsibility for any defects that may occur in equipment using any SHARP devices shown in catalogs, data books, etc. Contact SHARP in order to obtain the latest version of the device specification sheets before using any SHARP's device. "

■ Electrical Characteristics

(Unless otherwise specified, condition shall be $I_o=0.5A, T_a=25^{\circ}C^{*4}$)

Parameter	Symbol	Conditions	MIN.	TYP.	MAX.	Unit	
Output voltage	V_o	$I_o=0.5A$	$V_{IN}=7V$	4.75	5.0	5.25	V
			$V_{IN}=11V$	8.55	9.0	9.45	
			$V_{IN}=14V$	11.4	12.0	12.6	
			$V_{IN}=7V$	4.88	5.0	5.12	
			$V_{IN}=11V$	8.78	9.0	9.22	
			$V_{IN}=14V$	11.7	12.0	12.3	
Load regulation	R_{egL}	^{*4}	-	0.3	2.0	%	
Line regulation	R_{egI}	$I_o=5mA, ^{*5}$	-	0.1	2.5	%	
Temperature coefficient of output voltage	T_cV_o	$I_o=5mA, T_j=0 \text{ to } 125^{\circ}C, ^{*6}$	-	± 0.01	-	$\%/^{\circ}C$	
Ripple rejection	RR	Refer to Fig. 2	45	60	-	dB	
Dropout voltage	V_{i-o}	^{*7} , $I_o=0.5A$	-	0.2	0.5	V	
^{*8} ON-state voltage for control	$V_{C(ON)}$	^{*6} , $I_o=0.5A$	2.0	-	-	V	
ON-state current for control	$I_{C(ON)}$	^{*6} , $I_o=0.5A, V_C=2.7V$	-	-	20	μA	
OFF-state voltage for control	$V_{C(OFF)}$	^{*6}	-	-	0.8	V	
OFF-state current for control	$I_{C(OFF)}$	^{*6} , $V_o=0.4A$	-	-	-0.4	mA	
Quiescent current	I_q	$I_o=0A, ^{*6}$	-	6.0	10.0	mA	

^{*4} PQ05RG1/11: $V_{IN}=7V, I_o=5mA \text{ to } 1.0A$
 PQ09RG1/11: $V_{IN}=11V, I_o=5mA \text{ to } 1.0A$
 PQ12RG1/11: $V_{IN}=14V, I_o=5mA \text{ to } 1.0A$

^{*5} PQ05RG1/11: $V_{IN}=6 \text{ to } 16V$
 PQ09RG1/11: $V_{IN}=10 \text{ to } 20V$
 PQ12RG1/11: $V_{IN}=13 \text{ to } 23V$

^{*6} PQ05RG1/11: $V_{IN}=7V$
 PQ09RG1/11: $V_{IN}=11V$
 PQ12RG1/11: $V_{IN}=14V$

^{*7} Input voltage shall be the value when output voltage is 95% in comparison with the initial value.

^{*8} In case of opening control terminal ④, output voltage turns on.

Fig.1 Test Circuit

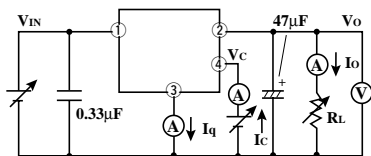
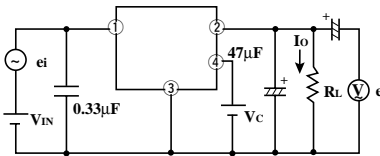
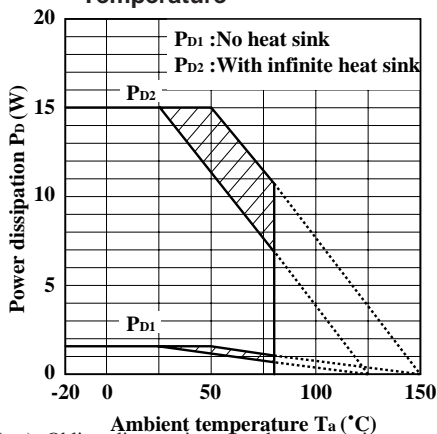

Fig.2 Test Circuit of Ripple Rejection



$f=120Hz$ (sine wave)
 $e_i=0.5V_{rms}$
 $V_{IN}=7V$ (PQ05RG1/PQ05RG11)
 $V_{IN}=11V$ (PQ09RG1/PQ09RG11)
 $V_{IN}=14V$ (PQ12RG1/PQ12RG11)
 $I_o=0.5A$
 $RR=20 \log (e_i/e_o)$

Fig.3 Power Dissipation vs. Ambient Temperature



Note) Oblique line portion : Overheat protection may operate in this area.

Fig.5 Overcurrent Protection Characteristics (Typical Value)

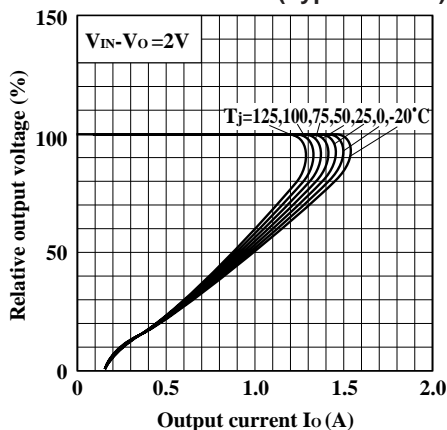

Fig.7 Output Voltage Deviation vs. Junction Temperature (PQ09RG1/11)

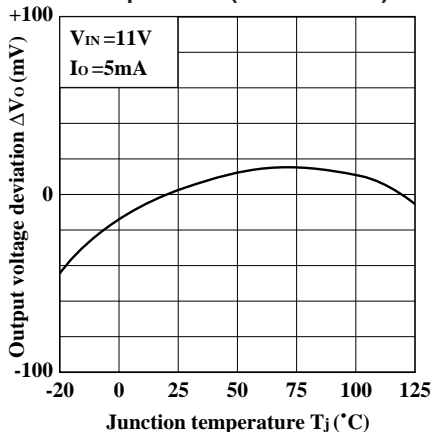

Fig.4 Overcurrent Protection Characteristics (Typical Value)

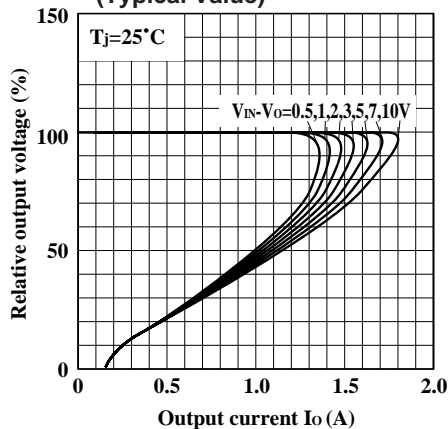

Fig.6 Output Voltage Deviation vs. Junction Temperature (PQ05RG1/11)

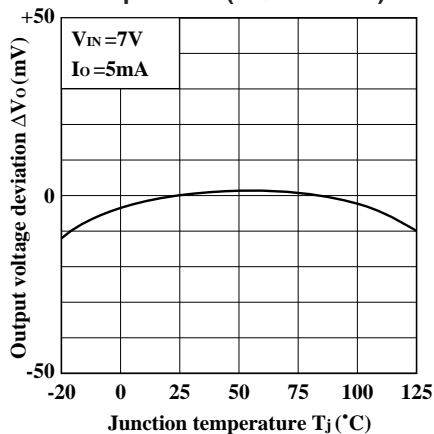

Fig.8 Output Voltage Deviation vs. Junction Temperature (PQ12RG1/11)

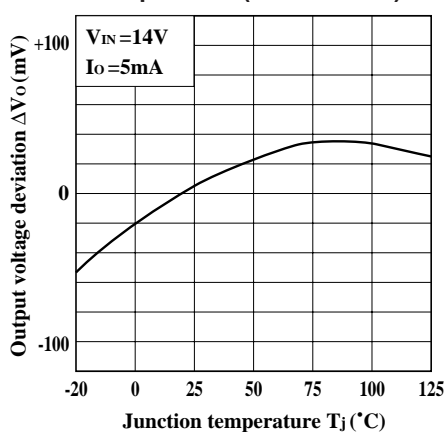

Fig.9 Output Voltage vs. Input Voltage (PQ05RG1/11)

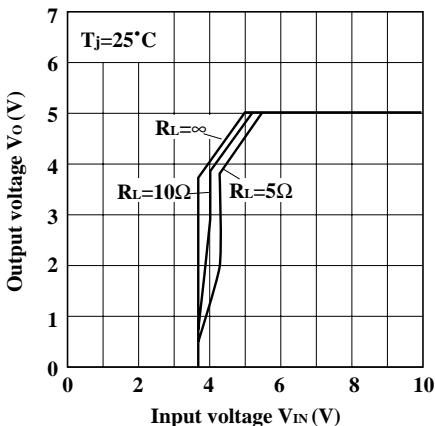

Fig.10 Output Voltage vs. Input Voltage (PQ09RG1/11)

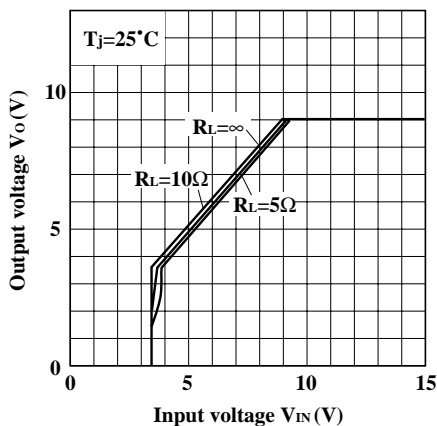

Fig.11 Output Voltage vs. Input Voltage (PQ12RG1/11)

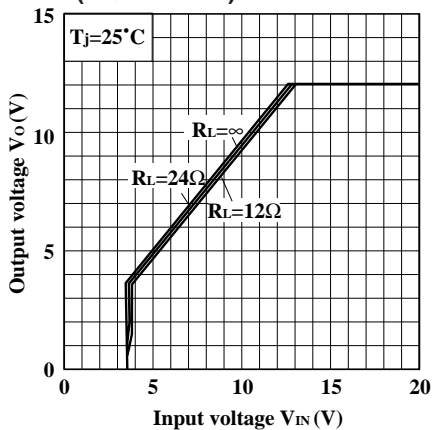

Fig.12 Circuit Operating Current vs. Input Voltage (PQ05RG1/11)

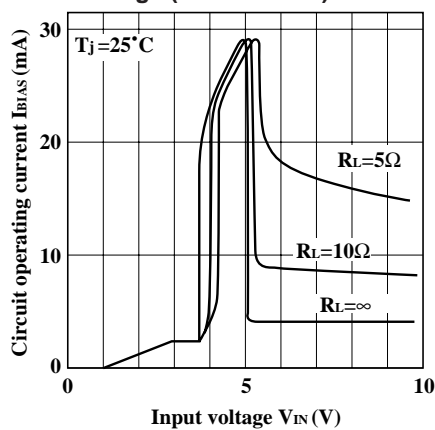

Fig.13 Circuit Operating Current vs. Input Voltage (PQ09RG1/11)

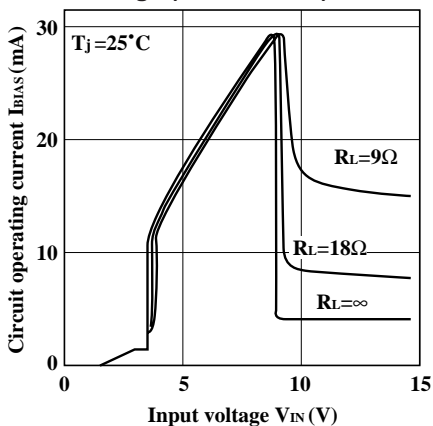

Fig.14 Circuit Operating Current vs. Input Voltage (PQ12RG1/11)

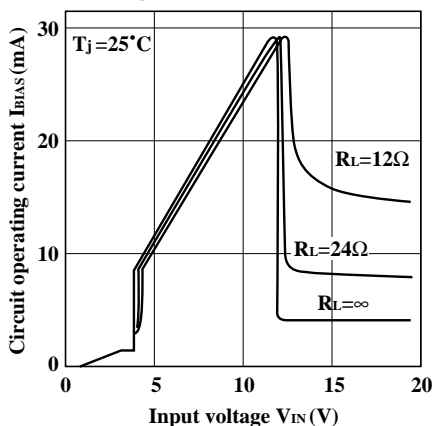

Fig.15 Dropout Voltage vs. Junction Temperature

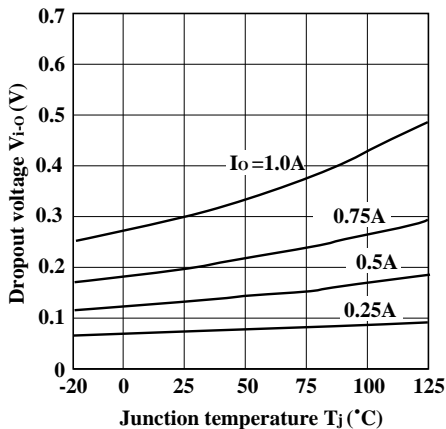

Fig.16 Quiescent Current vs. Input Voltage (PQ05RG1/11)

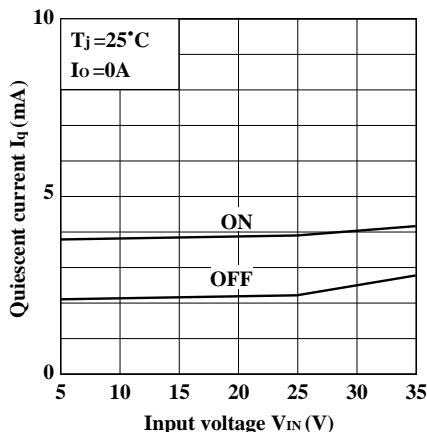

Fig.17 Quiescent Current vs. Input Voltage (PQ09RG1/11)

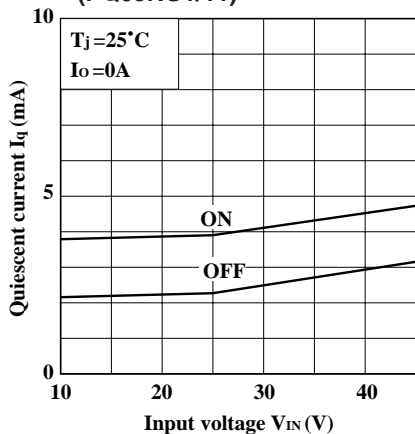

Fig.18 Quiescent Current vs. Input Voltage (PQ12RG1/11)

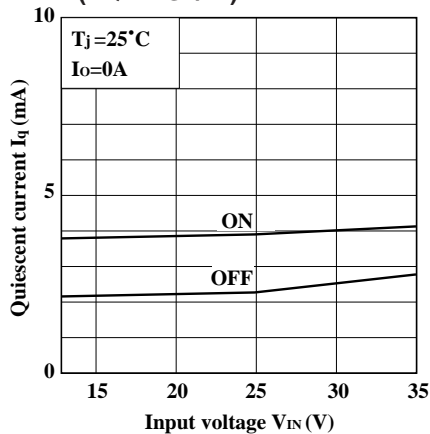

Fig.19 Quiescent Current vs. Junction Temperature

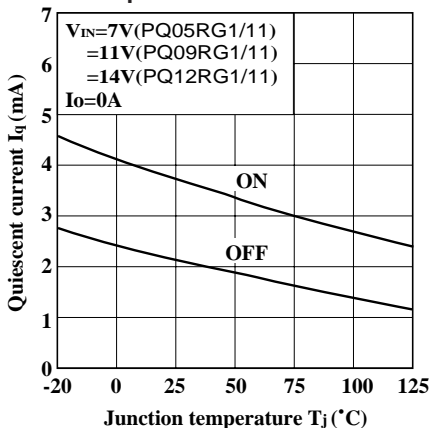

Fig.20 Ripple Rejection vs. Output Current

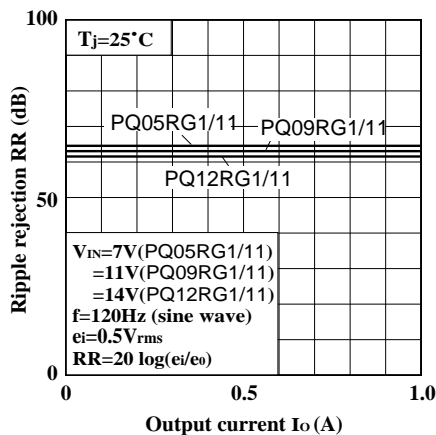

Fig.21 Ripple Rejection vs. Input Ripple Frequency

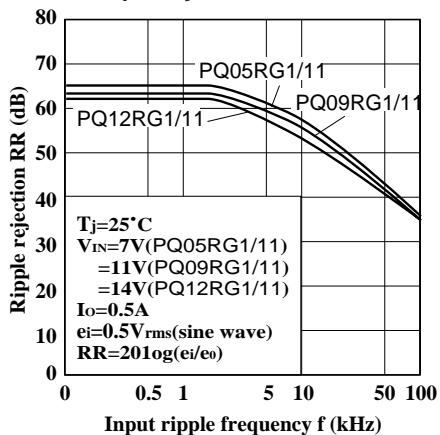

Fig.22 Input-Output Reverse Current vs. Input-Output Reverse Voltage

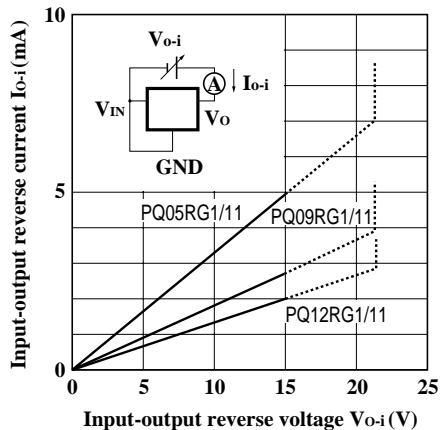

Fig.23 Output Peak Current vs. Junction Temperature

