

# PQ07VZ5M2Z/PQ07VZ012Z

Low Voltage Operation Type Low Power-Loss Voltage Regulator

## Features

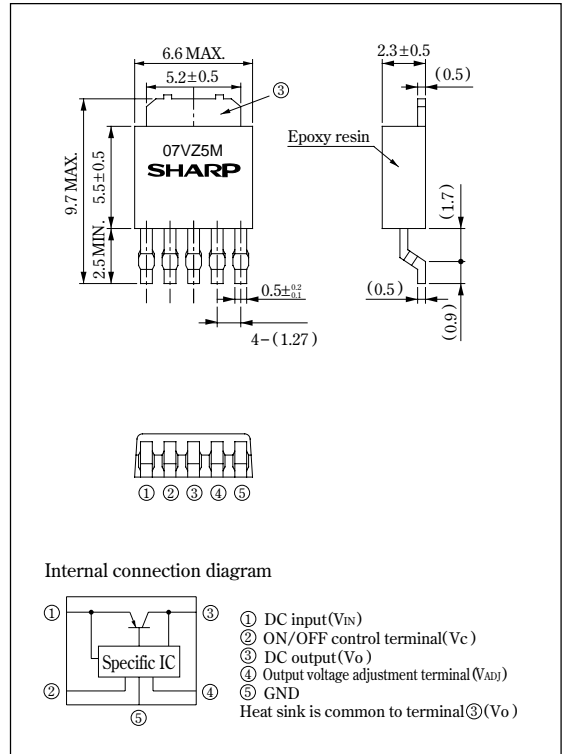
- Low power-loss  
(Dropout voltage: MAX. 0.5V)
- Compact surface mount type package  
(Equivalent to SC-63)
- Low voltage operation (Minimum supply voltage: 3.0V)
- 0.5A output : PQ07VZ5M2Z  
1.0A output : PQ07VZ012Z
- Variable output voltage (1.5V to 7V)
- High-precision output type  
(Reference voltage precision:  $\pm 2.0\%$ )
- Low dissipation current at OFF-state ( $I_{qs}$ : MAX. 5 $\mu$ A)
- Tape packaged type is also available.  
( $\phi 330$ mm reel: 3 000pcs.)
- Overcurrent, overheat protection functions

## Applications

- Personal information tools
- Amusement equipment

## Outline Dimensions

(Unit : mm)



## Absolute Maximum Ratings

( $T_a = 25^\circ\text{C}$ )

Parameter	Symbol	Rating	Unit
*1 Input voltage	$V_{IN}$	10	V
Dropout voltage	$V_{i-o}$	5	V
*1 ON/OFF control terminal voltage	$V_C$	10	V
Output adjustment terminal voltage	$V_{ADJ}$	7	V
*2 Output current	PQ07VZ5M2Z	0.5	A
	PQ07VZ012Z	1	
*3 Power dissipation	$P_D$	8	W
Junction temperature	$T_j$	150	$^\circ\text{C}$
Operating temperature	$T_{opr}$	-20 to +80	$^\circ\text{C}$
Storage temperature	$T_{stg}$	-40 to +150	$^\circ\text{C}$
Soldering temperature	$T_{sol}$	260 (For 10s)	$^\circ\text{C}$

\*1 All are open except GND and applicable terminals.

\*2  $P_D$ : With infinite heat sink

\*3 Overheat protection may operate at  $125 \leq T_j < 150^\circ\text{C}$ .

• Please refer to the chapter " Handling Precautions ".

SHARP

www.DataSheet4U.com

Notice In the absence of confirmation by device specification sheets, SHARP takes no responsibility for any defects that may occur in equipment using any SHARP devices shown in catalogs, data books, etc. Contact SHARP in order to obtain the latest device specification sheets before using any SHARP device.  
 Internet Internet address for Electronic Components Group <http://sharp-world.com/ecg/>

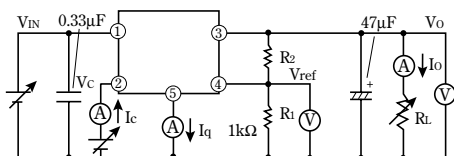
**Electrical Characteristics**

(Unless otherwise specified,  $V_{IN}=5V$ ,  $I_o=0.3A$ [PQ07VZ5M2Z],  $I_o=0.5A$ [PQ07VZ012Z],  $V_o=3V$ ( $R_1=1k\Omega$ ),  $V_c=2.7V$ ,  $T_a=25^\circ C$ )

Parameter	Symbol	Conditions	MIN.	TYP.	MAX.	Unit
Input voltage	$V_{IN}$	—	3.0	—	10	V
Output voltage	$V_o$	—	1.5	—	7.0	V
Load regulation	RegL	$I_o=5mA$ to $0.5A$	—	0.2	2.0	%
		$I_o=5mA$ to $1.0A$	—	—	—	—
Line regulation	$RegI$	$V_{IN}=4$ to $10V$ , $I_o=5mA$	—	0.2	2.5	%
Reference voltage	$V_{ref}$	—	1.225	1.25	1.275	V
Temperature coefficient of reference voltage	$T_C V_{ref}$	$T_j=0$ to $125^\circ C$ , $I_o=5mA$	—	$\pm 1.0$	—	%
Ripple rejection	RR	$f=120Hz$ sine wave, $e_i=0.5V_{rms}$	45	60	—	dB
Dropout voltage	$V_{i-o}$	$V_{IN}=3V$ , $I_o=0.3A$	—	—	0.5	V
		$V_{IN}=3V$ , $I_o=0.5A$	—	—	—	—
ON-state voltage for control	$V_c(ON)$	—	2.0	—	—	V
ON-state current for control	$I_c(ON)$	—	—	—	200	$\mu A$
OFF-state voltage for control	$V_c(OFF)$	$I_o=0A$	—	—	0.8	V
OFF-state current for control	$I_c(OFF)$	$V_c=0.4V$ , $I_o=0A$	—	—	2	$\mu A$
Quiescent current	$I_q$	$I_o=0A$	—	4	7	mA
Output OFF-state consumption current	$I_{qs}$	$V_c=0.4V$	—	—	5	$\mu A$

\*4 In case of opening ON/OFF control terminal ②, output voltage turns off.

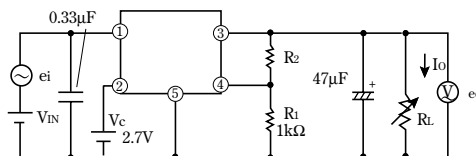
**Fig. 1 Test Circuit**



$$V_o = V_{ref} \times \left( 1 + \frac{R_2}{R_1} \right)$$

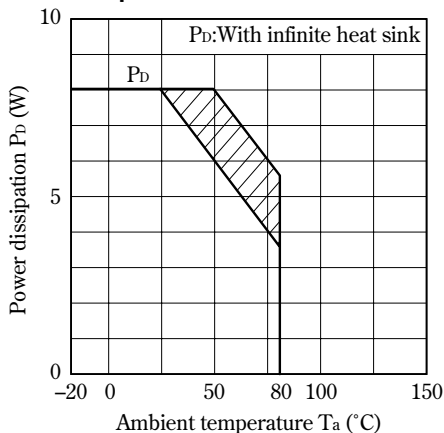
[ $R_1=1k\Omega$ ,  $V_{ref}$  Nearly=1.25V]

**Fig. 2 Test Circuit of Ripple Rejection**



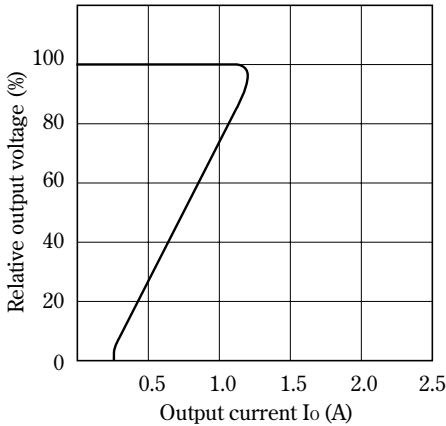
$f=120Hz$ (sine wave)  
 $e_i(rms)=0.5V$   
 $I_o=0.3A$   
 $RR=20 \log(e_i(rms)/e_o(rms))$   
 $V_{IN}=5V$   
 $V_o=3V$ ( $R_1=1k\Omega$ )

**Fig. 3 Power Dissipation vs. Ambient Temperature**

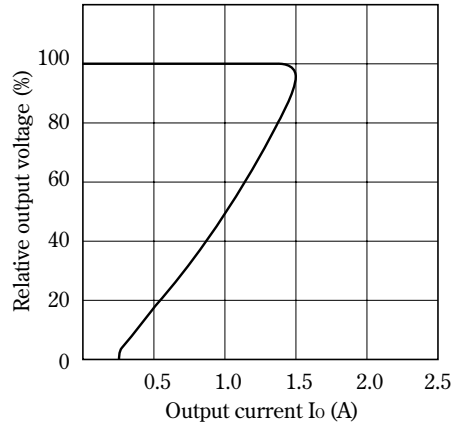


Oblique line portion : Overheat protection may operate in this area.

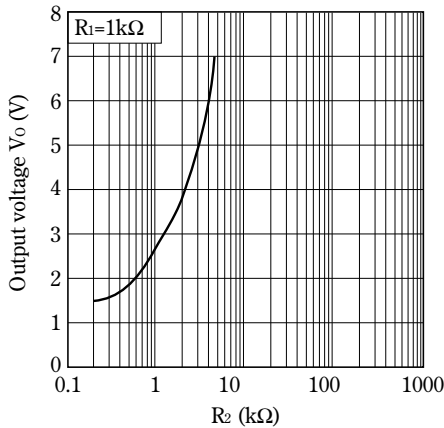
**Fig. 4 Overcurrent Protection Characteristics (Typical Value) (PQ07VZ5M2Z)**



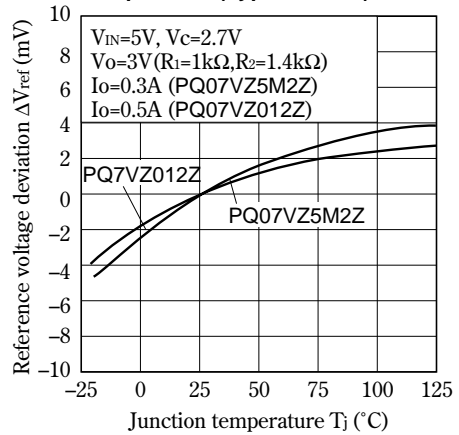
**Fig. 5 Overcurrent Protection Characteristics (Typical Value) (PQ07VZ012Z)**



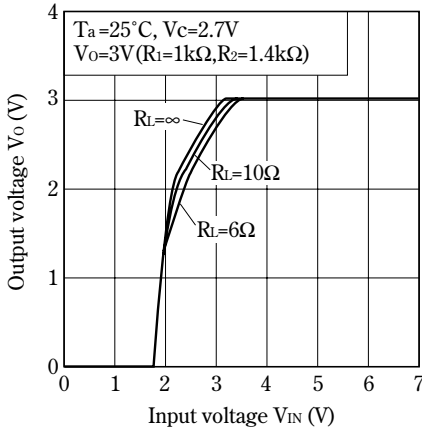
**Fig. 6 Output Voltage Adjustment Characteristics**



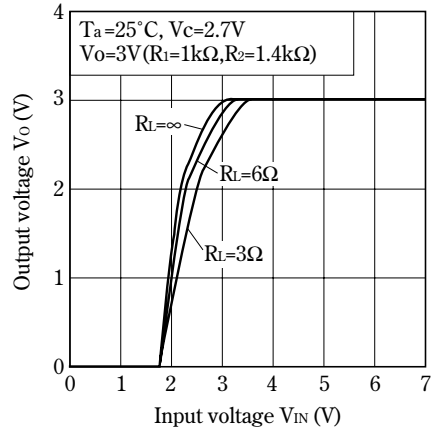
**Fig. 7 Reference Voltage Deviation vs. Junction Temperature (Typical Value)**



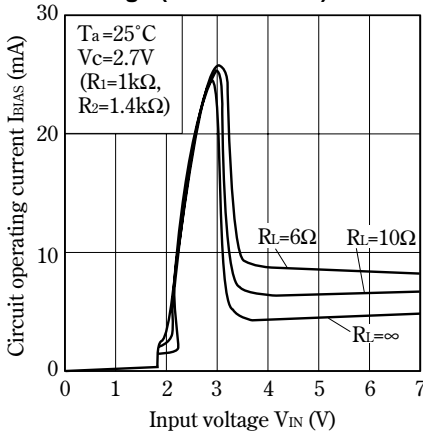
**Fig. 8 Output Voltage vs. Input Voltage (PQ07VZ5M2Z)**



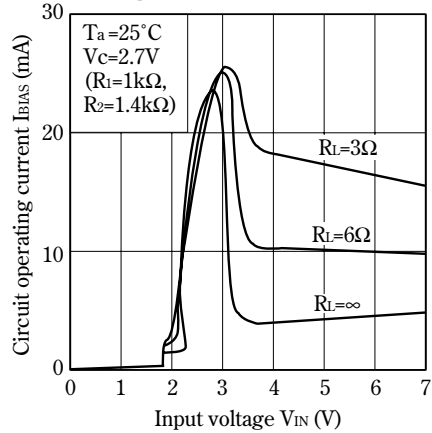
**Fig. 9 Output Voltage vs. Input Voltage (PQ07VZ012Z)**



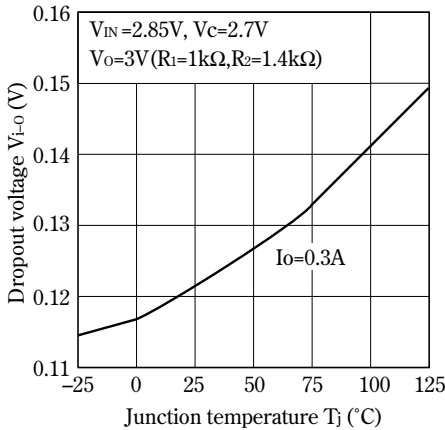
**Fig.10 Circuit Operating Current vs. Input Voltage (PQ07VZ5M2Z)**



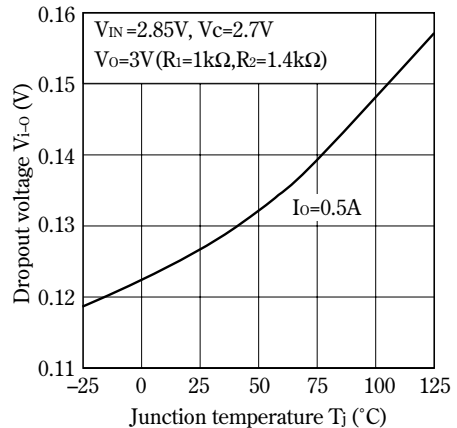
**Fig.11 Circuit Operating Current vs. Input Voltage (PQ07VZ012Z)**



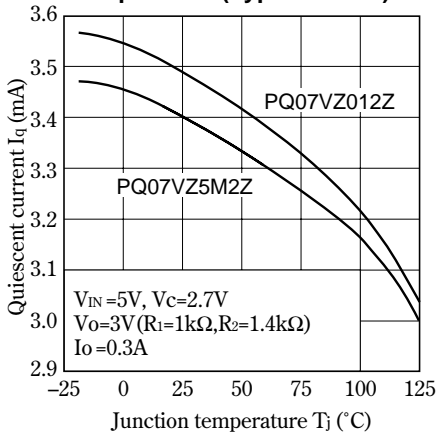
**Fig.12 Dropout Voltage vs. Junction Temperature (Typical Value) (PQ07VZ5M2Z)**



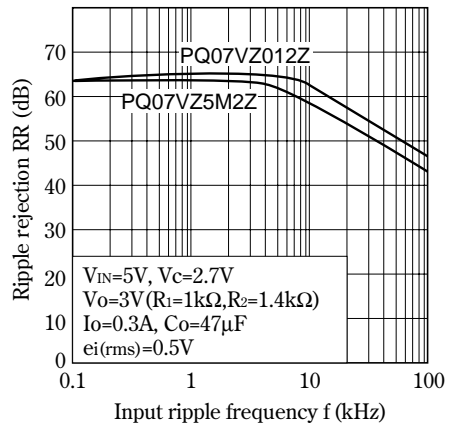
**Fig.13 Dropout Voltage vs. Junction Temperature (Typical Value) (PQ07VZ012Z)**



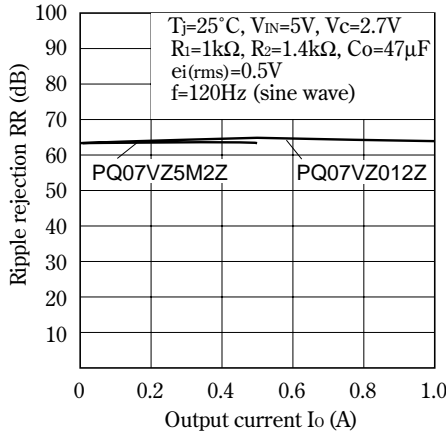
**Fig.14 Quiescent Current vs. Junction Temperature (Typical Value)**



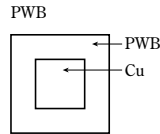
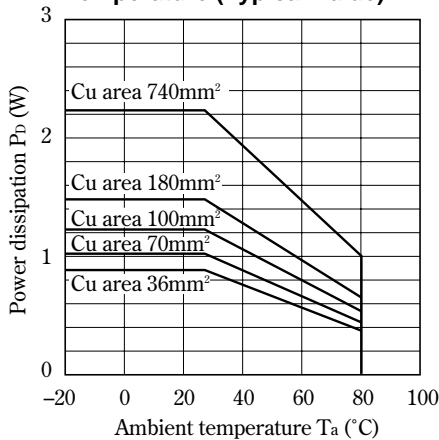
**Fig.15 Ripple Rejection vs. Input Ripple Frequency**



**Fig.16 Ripple Rejection vs. Output Current (PQ07VZ5M2Z)**

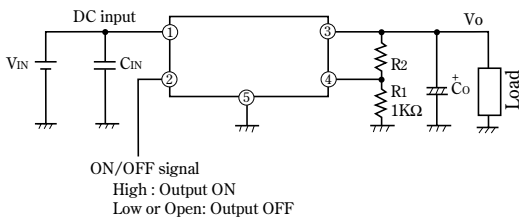


**Fig.17 Power Dissipation vs. Ambient Temperature (Typical Value)**



Material : Glass-cloth epoxy resin  
 Size : 50x50x1.6mm  
 Cu thickness : 35μm

**Typical Application**



**Model Line-ups for Tape-packaged Products**

Output current	Sleeve-packaged products	Tape-packaged products
0.5A output	PQ07VZ5M2ZZ	PQ07VZ5M2ZP
1.0A output	PQ07VZ012ZZ	PQ07VZ012ZP

## NOTICE

- The circuit application examples in this publication are provided to explain representative applications of SHARP devices and are not intended to guarantee any circuit design or license any intellectual property rights. SHARP takes no responsibility for any problems related to any intellectual property right of a third party resulting from the use of SHARP's devices.
- Contact SHARP in order to obtain the latest device specification sheets before using any SHARP device. SHARP reserves the right to make changes in the specifications, characteristics, data, materials, structure, and other contents described herein at any time without notice in order to improve design or reliability. Manufacturing locations are also subject to change without notice.
- Observe the following points when using any devices in this publication. SHARP takes no responsibility for damage caused by improper use of the devices which does not meet the conditions and absolute maximum ratings to be used specified in the relevant specification sheet nor meet the following conditions:
  - (i) The devices in this publication are designed for use in general electronic equipment designs such as:
    - Personal computers
    - Office automation equipment
    - Telecommunication equipment [terminal]
    - Test and measurement equipment
    - Industrial control
    - Audio visual equipment
    - Consumer electronics
  - (ii) Measures such as fail-safe function and redundant design should be taken to ensure reliability and safety when SHARP devices are used for or in connection with equipment that requires higher reliability such as:
    - Transportation control and safety equipment (i.e., aircraft, trains, automobiles, etc.)
    - Traffic signals
    - Gas leakage sensor breakers
    - Alarm equipment
    - Various safety devices, etc.
  - (iii) SHARP devices shall not be used for or in connection with equipment that requires an extremely high level of reliability and safety such as:
    - Space applications
    - Telecommunication equipment [trunk lines]
    - Nuclear power control equipment
    - Medical and other life support equipment (e.g., scuba).
- Contact a SHARP representative in advance when intending to use SHARP devices for any "specific" applications other than those recommended by SHARP or when it is unclear which category mentioned above controls the intended use.
- If the SHARP devices listed in this publication fall within the scope of strategic products described in the Foreign Exchange and Foreign Trade Control Law of Japan, it is necessary to obtain approval to export such SHARP devices.
- This publication is the proprietary product of SHARP and is copyrighted, with all rights reserved. Under the copyright laws, no part of this publication may be reproduced or transmitted in any form or by any means, electronic or mechanical, for any purpose, in whole or in part, without the express written permission of SHARP. Express written permission is also required before any use of this publication may be made by a third party.
- Contact and consult with a SHARP representative if there are any questions about the contents of this publication.