

PHOTO COUPLER PS1001

PHOTO COUPLER INDUSTRIAL USE

DESCRIPTION

The PS1001 is an optically coupled isolator containing a GaAs light emitting diode and an NPN silicon photo transistor.

PACKAGE DIMENSIONS

in millimeters (inches)

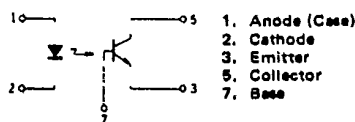
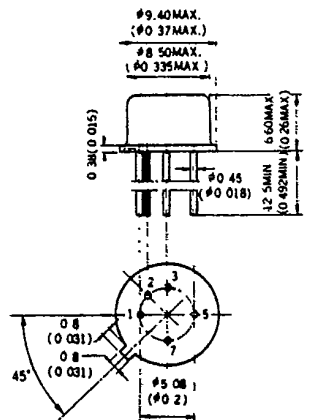

1. Anode (Case)
2. Cathode
3. Emitter
5. Collector
7. Base

FEATURES

- High isolation voltage 1000V Rating
- High transfer ratio 20% MIN.
- High speed switching $t_r, t_f = 5.0 \mu s$ TYP.
- Economical, compact, TO-5 hermetic package.

APPLICATIONS

- Interface circuit for various instrumentations, control equipments.
- Chopper circuits.
- Computer and peripheral manufactures.
- Pulse transformer.
- Data communication equipment.
- Traffic signal

ABSOLUTE MAXIMUM RATINGS ($T_a = 25^\circ C$)

Diode			
Reverse Voltage	V_R	5.0	V
Forward Current	I_F	60	mA
Power Dissipation	P_D	100	mW
Transistor			
Collector to Emitter Voltage	V_{CEO}	30	V
Collector Current	I_C	50	mA
Power Dissipation	P_C	150	mW
Isolation Voltage *1	BV	1000	V _{DC}
Storage Temperature	T_{stg}	-65 to +150	°C
Operating Temperature	T_{opt}	-20 to +100	°C

ELECTRICAL CHARACTERISTICS (Ta = 25°C)

CHARACTERISTIC		SYMBOL	MIN.	TYP.	MAX.	UNIT	TEST CONDITIONS
Diode	Forward Voltage	V_F		1.1	1.4	V	$I_F = 20\text{ mA}$
	Reverse Current	I_R			20	μA	$V_R = 4.0\text{ V}$
	Junction Capacitance	C_t		100		pF	$V = 0, f = 1.0\text{ MHz}$
Transistor	Collector to Emitter Dark Current	I_{CEO}			200	nA	$V_{CE} = 10\text{ V}, I_F = 0$
	DC Current Gain	h_{FE}		400			$I_C = 4.0\text{ mA}, V_{CE} = 5.0\text{ V}$
Coupled	Current Transfer Ratio	$CTR(I_C/I_F)$	20	30		%	$I_F = 20\text{ mA}, V_{CE} = 5.0\text{ V}$
	Collector Saturation Voltage	$V_{CE(sat)}$			0.3	V	$I_F = 20\text{ mA}, I_C = 2.0\text{ mA}$
	Isolation Resistance	R_{1-2}	10^{11}			Ω	$V_{in-out} = 1.0\text{ kV}$
	Isolation Capacitance	C_{1-2}		2		pF	$V = 0, f = 1.0\text{ MHz}$
	Rise Time	t_r		5.0		μs	$V_{CC} = 5.0\text{ V}, I_F = 20\text{ mA}, R_L = 100\Omega * 2$
	Fall Time	t_f		5.0		μs	$V_{CC} = 5.0\text{ V}, I_F = 20\text{ mA}, R_L = 100\Omega * 2$

1. Measuring Condition

DC voltage for 1 minute at $T_a = 25^\circ\text{C}$,
 RH = 60%
 Between input (pin No. 1 and No. 2 Common)
 and output (pin No. 3, 5 and No. 7 Common)

2. Test Circuit for Switching Time

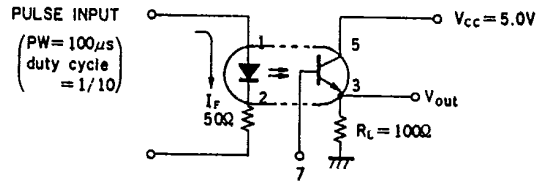

TYPICAL CHARACTERISTICS (Ta = 25°C)

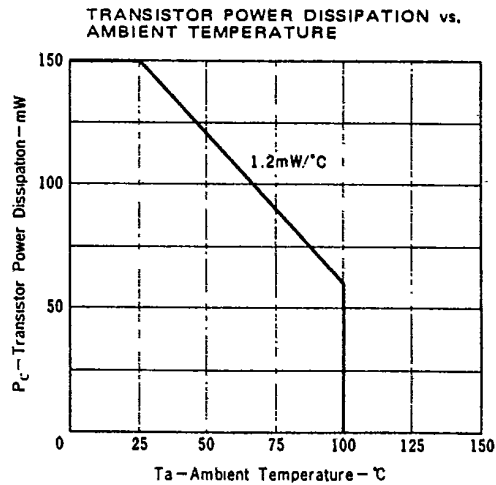
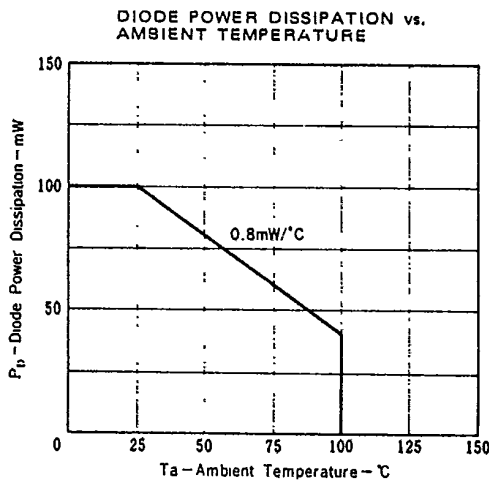

T-41-83

PS1001

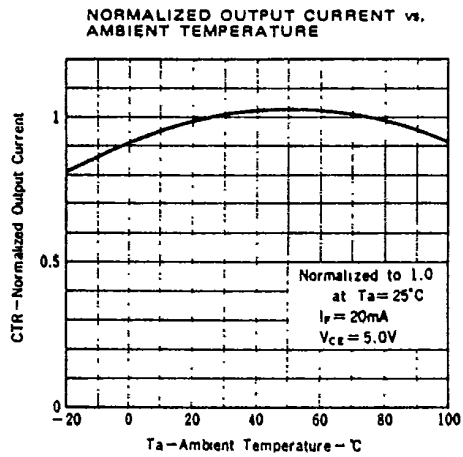
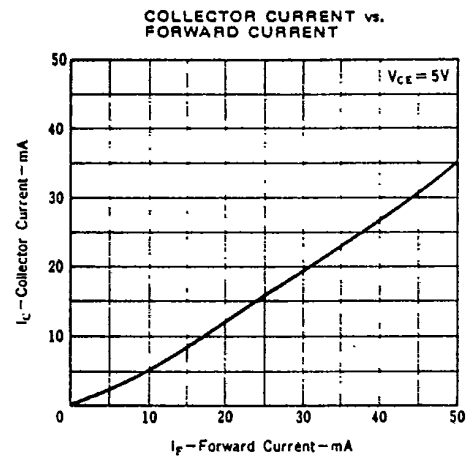
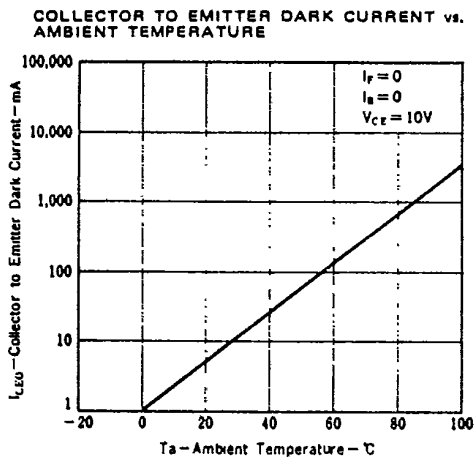
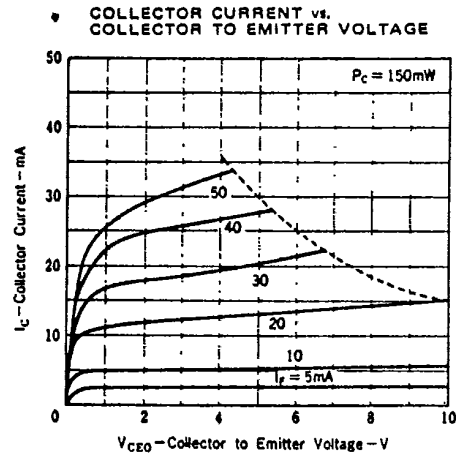
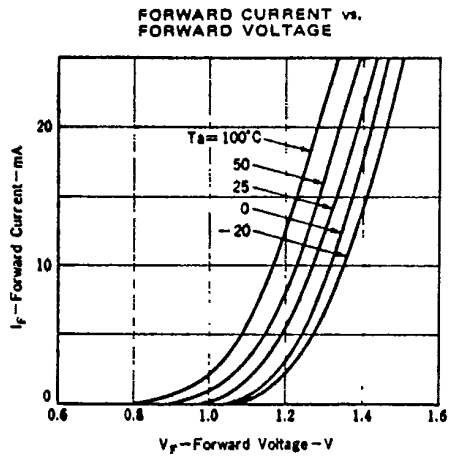

PS1001

T-41-83

COLLECTOR CURRENT vs. COLLECTOR SATURATION VOLTAGE

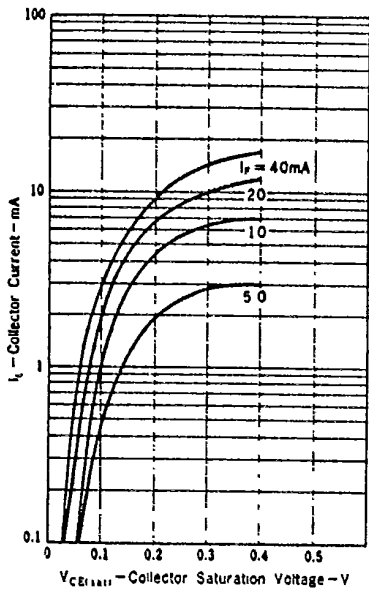

SWITCHING TIME vs. LOAD RESISTANCE

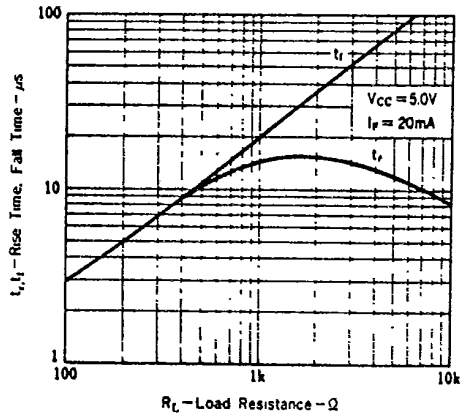

FREQUENCY RESPONSE

