

Intellimod™ Module Dual-In-Line Intelligent Power Module 20 Amperes/600 Volts

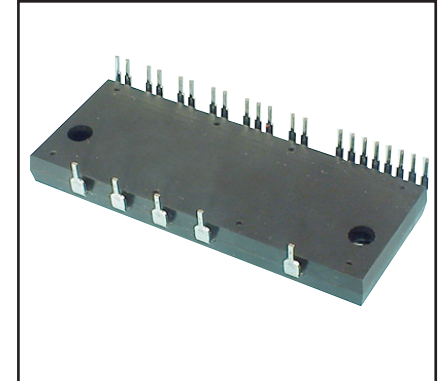
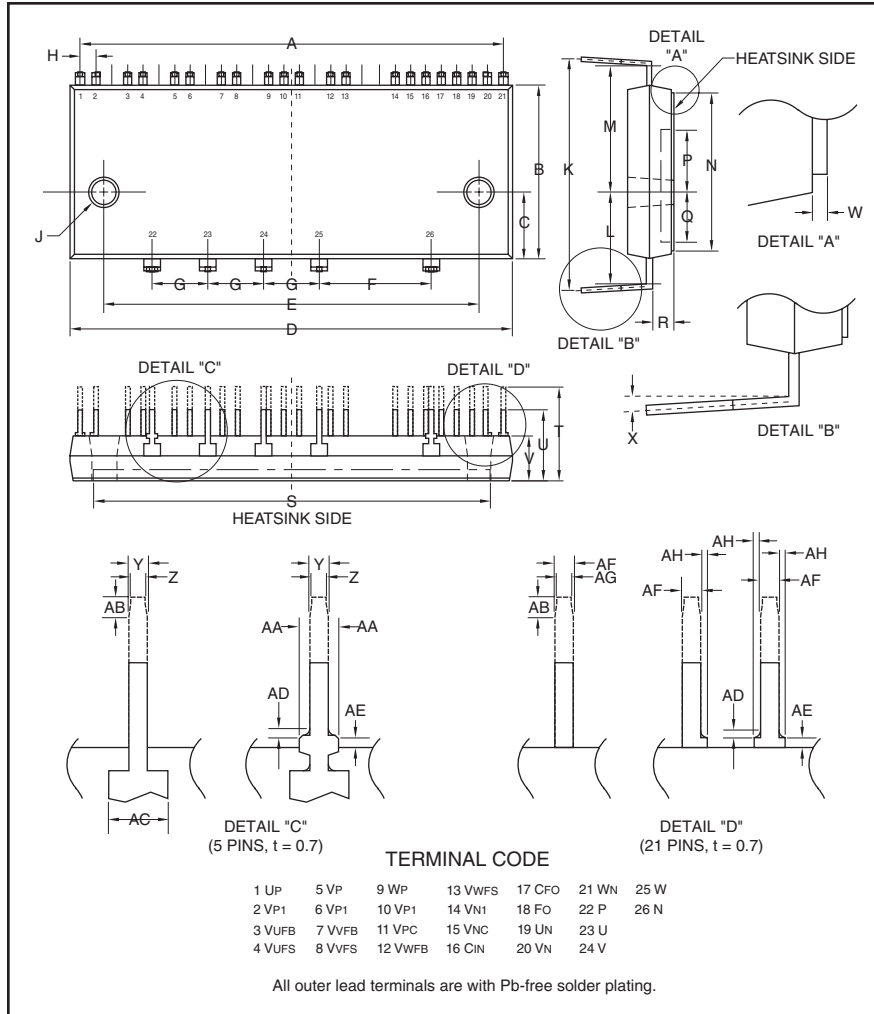

Description:

DIP-IPMs are intelligent power modules that integrate power devices, drivers, and protection circuitry in an ultra compact dual-in-line transfer-mold package for use in driving small three phase motors. Use of 5th generation CSTBT Chip Technology, DIP packaging, and application specific HVICs allow the designer to reduce inverter size and overall design time.

Features:

- Compact Packages
- Single Power Supply
- Integrated HVICs
- Direct Connection to CPU

Applications:

- Washing Machines
- Refrigerators
- Air Conditioners
- Small Servo Motors
- Small Motor Control

Ordering Information:

PS21265-P (short pin) /
PS21265-AP (long pin) are 600V,
20 Ampere DIP Intelligent Power
Modules.

Outline Drawing and Circuit Diagram

Dimensions	Inches	Millimeters
A	2.98	75.6
B	1.22±0.02	31.0±0.5
C	0.45±0.02	11.5±0.5
D	3.11±0.02	79.0±0.5
E	2.64±0.015	67.0±0.3
F	0.79±0.01	20.0±0.3
G	0.4±0.015	10.0±0.3
H	0.11±0.015	2.8±0.3
J	0.18±0.01 Dia.	4.5±0.2 Dia.
K	1.37±0.02	34.9±0.5
L	0.53±0.02	13.4±0.5
M	0.84±0.02	21.4±0.5
N	1.10±0.02	28.0±0.5
P	0.45	11.5
Q	0.33	8.5
R	0.15±0.01	3.8±0.2

Dimensions	Inches	Millimeters
S	2.80	71.0
T	0.62±0.02	16.0±0.5
U	0.49±0.02	12.8±0.5
V	0.31±0.02	8.0±0.5
W	0.02±0.01	0.5±0.2
X	0 ~ 5°	0 ~ 5°
Y	0.04±0.01	1.0±0.2
Z	0.03	0.7
AA	0.03±0.01	0.7±0.2
AB	0.04	1.0
AC	0.1	2.5
AD	0.02 Max.	0.5 Max.
AE	0.024±0.2	0.6±0.5
AF	0.03±0.01	0.8±0.02
AG	0.024	0.6
AH	0.02±0.01	0.45±0.02



PS21265-P / PS21265-AP
Intellimod™ Module
Dual-In-Line Intelligent Power Module
 20 Amperes/600 Volts

Absolute Maximum Ratings, $T_j = 25^\circ\text{C}$ unless otherwise specified

Characteristics	Symbol	PS21265-P / PS21265-AP	Units
Power Device Junction Temperature*	T_j	-20 to 125	$^\circ\text{C}$
Module Case Operation Temperature (See T_C Measurement Point Illustration)	T_C	-20 to 100	$^\circ\text{C}$
Storage Temperature	T_{stg}	-40 to 125	$^\circ\text{C}$
Mounting Torque, M4 Mounting Screws	—	13	in-lb
Module Weight (Typical)	—	54	Grams
Self-protection Supply Voltage Limit (Short Circuit Protection Capability)**	$V_{CC(prot.)}$	400	Volts
Isolation Voltage, AC 1 minute, 60Hz Sinusoidal, Connection Pins to Heatsink Plate	V_{ISO}	2500	Volts

*The maximum junction temperature rating of the power chips integrated within the DIP-IPM is 150°C ($@T_C \leq 100^\circ\text{C}$). However, to ensure safe operation of the DIP-IPM, the average junction temperature should be limited to $T_{j(avg)} \leq 125^\circ\text{C}$ ($@T_C \leq 100^\circ\text{C}$).

** $V_D = 13.5 \sim 16.5\text{V}$, Inverter Part, $T_j = 125^\circ\text{C}$, Non-repetitive, Less than $2\mu\text{s}$

IGBT Inverter Sector

Collector-Emitter Voltage ($T_C = 25^\circ\text{C}$)	V_{CES}	600	Volts
Collector Current ($T_C = 25^\circ\text{C}$)	$\pm I_C$	20	Amperes
Peak Collector Current ($T_C = 25^\circ\text{C}$, $<1\text{ms}$)	$\pm I_{CP}$	40	Amperes
Supply Voltage (Applied between P - N)	V_{CC}	450	Volts
Supply Voltage, Surge (Applied between P - N)	$V_{CC(surge)}$	500	Volts
Collector Dissipation ($T_C = 25^\circ\text{C}$, per 1 Chip)	P_C	51.2	Watts

Control Sector

Supply Voltage (Applied between V_{P+} - V_{PC} , V_{N+} - V_{NC})	V_D	20	Volts
Supply Voltage (Applied between V_{UFB} - V_{UFS} , V_{VFB} - V_{VFS} , V_{WFB} - V_{WFS})	V_{DB}	20	Volts
Input Voltage (Applied between U_P , V_P , W_P - V_{PC} , U_N , V_N , W_N - V_{NC})	V_{IN}	-0.5 ~ $V_D+0.5$	Volts
Fault Output Supply Voltage (Applied between F_O - V_{NC})	V_{FO}	-0.5 ~ $V_D+0.5$	Volts
Fault Output Current (Sink Current at F_O Terminal)	I_{FO}	1	mA
Current Sensing Input Voltage (Applied between C_{IN} - V_{NC})	V_{SC}	-0.5 ~ $V_D+0.5$	Volts

PS21265-P / PS21265-AP
 Intellimod™ Module
 Dual-In-Line Intelligent Power Module
 20 Amperes/600 Volts

Electrical and Mechanical Characteristics, $T_j = 25^\circ\text{C}$ unless otherwise specified

Characteristics	Symbol	Test Conditions	Min.	Typ.	Max.	Units
IGBT Inverter Sector						
Collector-Emitter Cutoff Current	I_{CES}	$V_{CE} = V_{CES}, T_j = 25^\circ\text{C}$	—	—	1.0	mA
		$V_{CE} = V_{CES}, T_j = 125^\circ\text{C}$	—	—	10	mA
Diode Forward Voltage	V_{EC}	$T_j = 25^\circ\text{C}, -I_C = 20\text{A}, V_{IN} = 0\text{V}$	—	1.5	2.0	Volts
Collector-Emitter Saturation Voltage	$V_{CE(sat)}$	$I_C = 20\text{A}, T_j = 25^\circ\text{C}, V_D = V_{DB} = 15\text{V}, V_{IN} = 5\text{V}$	—	1.55	2.05	Volts
		$I_C = 20\text{A}, T_j = 125^\circ\text{C}, V_D = V_{DB} = 15\text{V}, V_{IN} = 5\text{V}$	—	1.65	2.15	Volts
Inductive Load Switching Times	t_{on}		0.65	1.25	1.85	μs
	t_{rr}	$V_{CC} = 300\text{V}, V_D = V_{DB} = 15\text{V},$	—	0.30	—	μs
	$t_{C(on)}$	$I_C = 20\text{A}, T_j = 125^\circ\text{C}, V_{IN} = 5 \leftrightarrow 0\text{V},$	—	0.40	0.60	μs
	t_{off}	Inductive Load (Upper-Lower Arm)	—	1.50	2.10	μs
	$t_{C(off)}$		—	0.50	0.80	μs

T_C Measurement Point

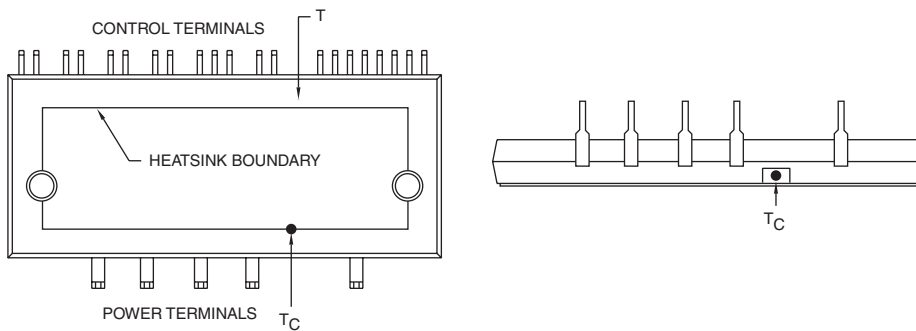



PS21265-P / PS21265-AP
 Intellimod™ Module
 Dual-In-Line Intelligent Power Module
 20 Amperes/600 Volts

Electrical and Mechanical Characteristics, T_j = 25°C unless otherwise specified

Characteristics	Symbol	Test Conditions	Min.	Typ.	Max.	Units
Control Sector						
Circuit Current	I _D	V _D = V _{DB} = 15V, V _{IN} = 5V, Total of V _{P1} -V _{PC} , V _{N1} -V _{NC}	—	—	7.00	mA
		V _D = V _{DB} = 15V, V _{IN} = 0V, Total of V _{P1} -V _{PC} , V _{N1} -V _{NC}	—	—	7.00	mA
		V _D = V _{DB} = 15V, V _{IN} = 5V, V _{UFB} -V _{UFS} , V _{VFB} -V _{VFS} , V _{WFB} -V _{WFS}	—	—	0.55	mA
		V _D = V _{DB} = 15V, V _{IN} = 0V, V _{UFB} -V _{UFS} , V _{VFB} -V _{VFS} , V _{WFB} -V _{WFS}	—	—	0.55	mA
Fault Output Voltage	V _{FOH}	V _{SC} = 0V, F _O Circuit: 10kΩ to 5V Pull-up	4.9	—	—	Volts
	V _{FOL}	V _{SC} = 1V, I _{FO} = 1mA	—	—	0.95	Volts
Input Current	I _{IN}	V _{IN} = 5V	1.0	1.5	2.00	mA
Short-Circuit Trip Level*	V _{SC(ref)}	T _C = 20 ~ 100°C, V _D = 15V	0.45	—	0.52	Volts
Supply Circuit Undervoltage Protection	UV _{DBt}	Trip Level, T _j ≤ 125°C	10.0	—	12.0	Volts
	UV _{DBr}	Reset Level, T _j ≤ 125°C	10.5	—	12.5	Volts
	UV _{Dt}	Trip Level, T _j ≤ 125°C	10.3	—	12.5	Volts
	UV _{Dr}	Reset Level, T _j ≤ 125°C	10.8	—	13.0	Volts
Fault Output Pulse Width**	t _{FO}	C _{FO} = 22nF	1.0	1.8	—	ms
ON Threshold Voltage	V _{th(on)}	Applied between U _P , V _P , W _P -V _{PC} ,	2.1	2.3	2.6	Volts
OFF Threshold Voltage	V _{th(off)}	U _N , V _N , W _N -V _{NC}	0.8	1.4	2.1	Volts

Thermal Characteristics

Characteristic	Symbol	Condition	Min.	Typ.	Max.	Units
Junction to Fin	R _{th(j-f)Q}	IGBT Part (Per 1/6 Module)	—	—	1.95	°C/W
Thermal Resistance	R _{th(j-f)D}	FWDi Part (Per 1/6 Module)	—	—	3.00	°C/W
Contact Thermal Resistance	R _{th(c-f)}	Case to Fin (Per 1 Module)	—	—	0.067	°C/W

* Short-Circuit protection is functioning only at the lower arms. Please select the value of the external shunt resistor such that the SC trip level is less than 30A.

** Fault signal is asserted when the lower arm short circuit or control supply under-voltage protective functions operate. The fault output pulse-width t_{FO} depends on the capacitance value of C_{FO} according to the following approximate equation: C_{FO} = (12.2 x 10⁻⁶) x t_{FO} (F) .



Powerex, Inc., 173 Pavilion Lane, Youngwood, Pennsylvania 15697 (724) 925-7272 www.pwr.com

PS21265-P / PS21265-AP
 Intellimod™ Module
 Dual-In-Line Intelligent Power Module
 20 Amperes/600 Volts

Recommended Conditions for Use

Characteristic	Symbol	Condition	Min.	Typ.	Max.	Units	
Supply Voltage	V_{CC}	Applied between P-N	0	300	400	Volts	
Control Supply Voltage	V_D	Applied between V_{P1} - V_{PC} , V_{N1} - V_{NC}	13.5	15.0	16.5	Volts	
	V_{DB}	Applied between V_{UFB} - V_{UFS} , V_{VFB} - V_{VFS} , V_{WFB} - V_{WFS}	13.0	15.0	18.5	Volts	
Control Supply Variation	ΔV_D , ΔV_{DB}	—	-1	—	1	Volts/ μ s	
PWM Input Frequency	f_{PWM}	$T_C \leq 100^\circ\text{C}$, $T_j \leq 125^\circ\text{C}$	—	—	20	kHz	
Allowable rms Current*	I_O	$V_{CC} = 300\text{V}$, $V_D = V_{DB} = 15\text{V}$, $f_{PWM} = 5\text{kHz}$, PF = 0.8, Sinusoidal, $T_j \leq 125^\circ\text{C}$, $T_C \leq 100^\circ\text{C}$	—	—	14.0	Arms	
		$V_{CC} = 300\text{V}$, $V_D = V_{DB} = 15\text{V}$, $f_{PWM} = 15\text{kHz}$, PF = 0.8, Sinusoidal, $T_j \leq 125^\circ\text{C}$, $T_f \leq 100^\circ\text{C}$	—	—	9.5	Arms	
Minimum Input	$P_{WIN(on)}$ **	—	0.3	—	—	μ s	
Pulse Width	$P_{WIN(off)}$ ***	Below Rated Current	$200 \leq V_{CC} \leq 350\text{V}$,	1.4	—	—	μ s
		Between Rated Current & 1.7 Times of Rated Current	$13.5 \leq V_D \leq 16.5\text{V}$,	2.5	—	—	μ s
		Between 1.7 Times of Rated & 2.0 Times of Rated Current	$13.0 \leq V_{DB} \leq 18.5\text{V}$,	—	—	—	μ s
			$-20^\circ\text{C} \leq T_C \leq 100^\circ\text{C}$,	3.0	—	—	μ s
			N-line Wiring Inductance Less Than 10nH	—	—	—	μ s
V_{NC} Variation	V_{NC}	Between V_{NC} -N (Including Surge)	-5.0	—	5.0	Volts	
Arm Shoot-through	t_{DEAD}	For Each Input Signal, $T_C < 100^\circ\text{C}$	2	—	—	μ s	
Blocking Time							

* The allowable rms current value depends on the actual application conditions.

**If input signal ON pulse is less than $P_{WIN(on)}$, the device may not respond.

***The IPM may fail to respond to an ON pulse if the preceding OFF pulse is less than $P_{WIN(off)}$.



PS21265-P / PS21265-AP
Intellimod™ Module
Dual-In-Line Intelligent Power Module
20 Amperes/600 Volts

COLLECTOR-EMITTER SATURATION VOLTAGE CHARACTERISTICS (TYPICAL)

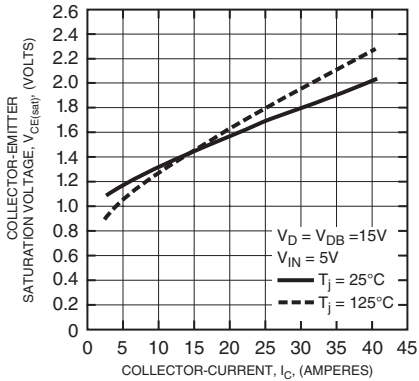

FREE-WHEEL DIODE FORWARD CHARACTERISTICS (TYPICAL)

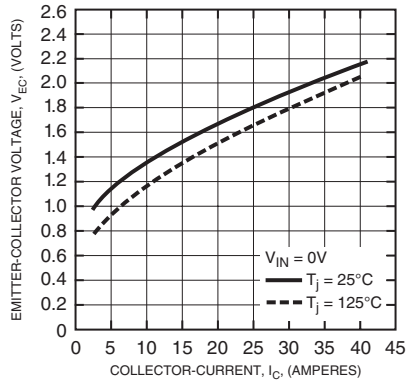

REVERSE RECOVERY CHARACTERISTICS (TYPICAL - N-SIDE)

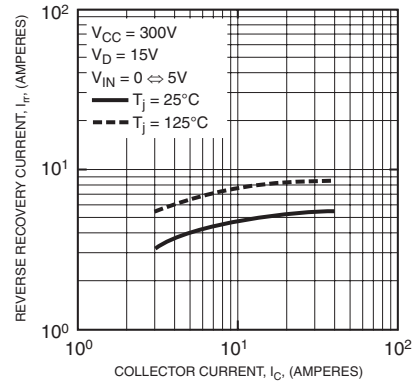

REVERSE RECOVERY CHARACTERISTICS (TYPICAL - N-SIDE)

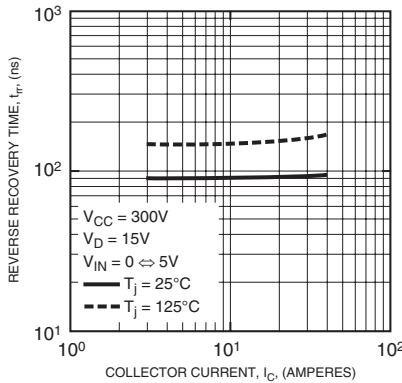

REVERSE RECOVERY CHARACTERISTICS (TYPICAL - P-SIDE)

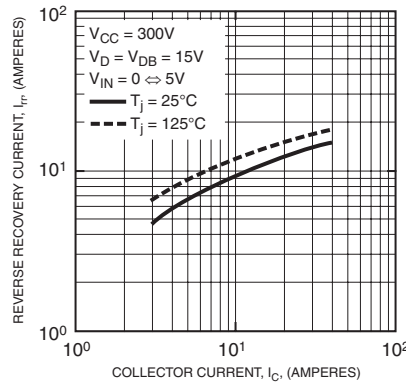

REVERSE RECOVERY CHARACTERISTICS (TYPICAL - P-SIDE)

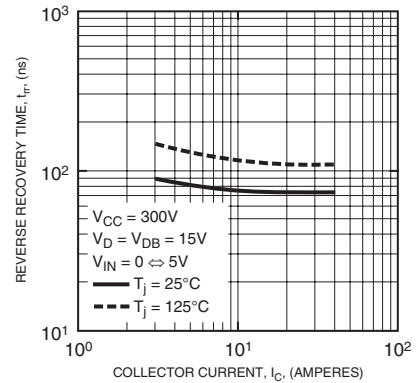

SWITCHING LOSS (ON) VS. COLLECTOR CURRENT (TYPICAL - N-SIDE)

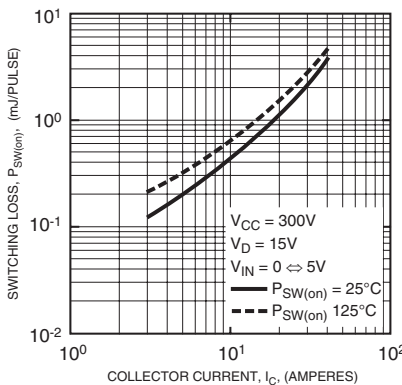

SWITCHING LOSS (OFF) VS. COLLECTOR CURRENT (TYPICAL - N-SIDE)

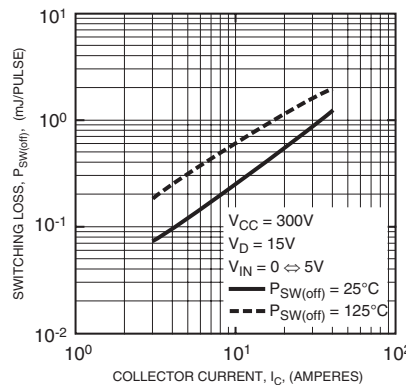

SWITCHING LOSS (ON) VS. COLLECTOR CURRENT (TYPICAL - P-SIDE)

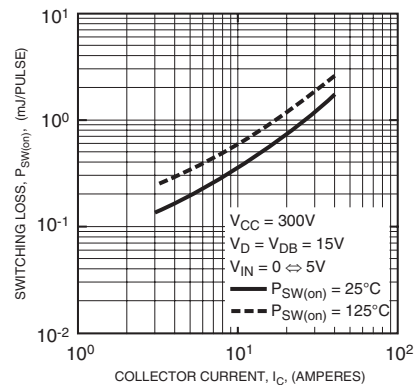



PS21265-P / PS21265-AP
Intellimod™ Module
Dual-In-Line Intelligent Power Module
20 Amperes/600 Volts

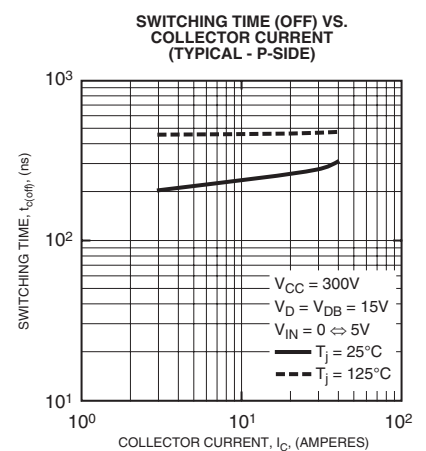
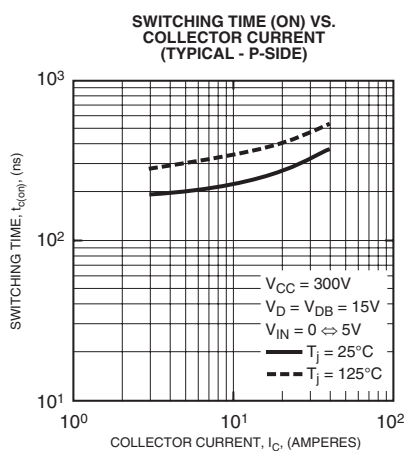
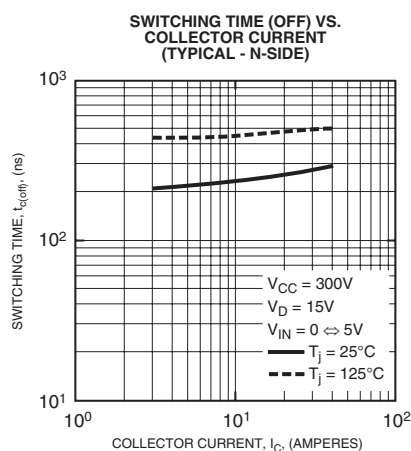
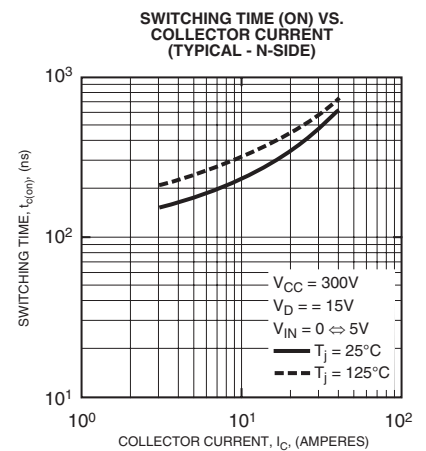
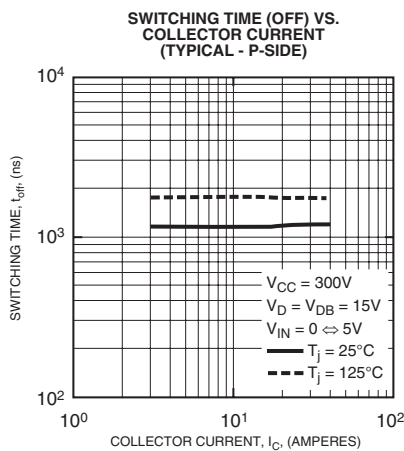
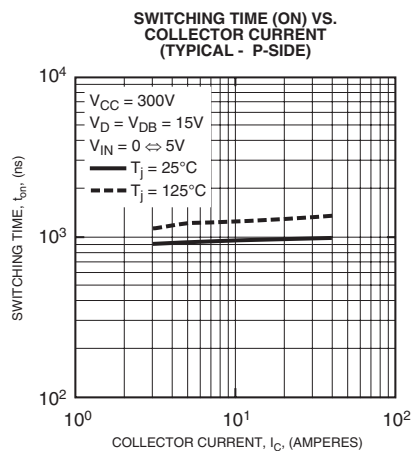
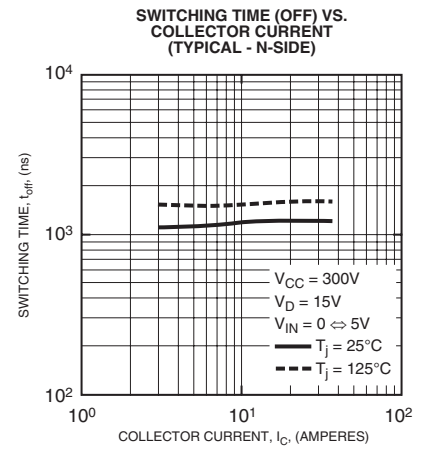
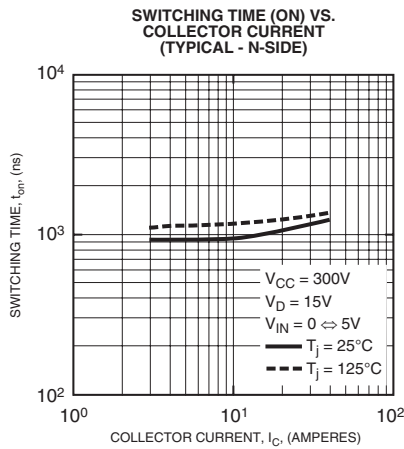
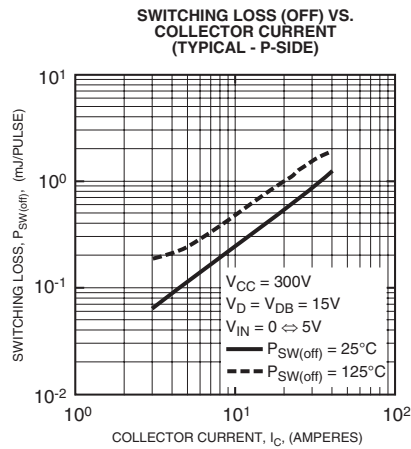

PS21265-P / PS21265-AP
Intellimod™ Module
Dual-In-Line Intelligent Power Module
 20 Amperes/600 Volts

DIP-IPM Application Circuit (Shown Pins Up)

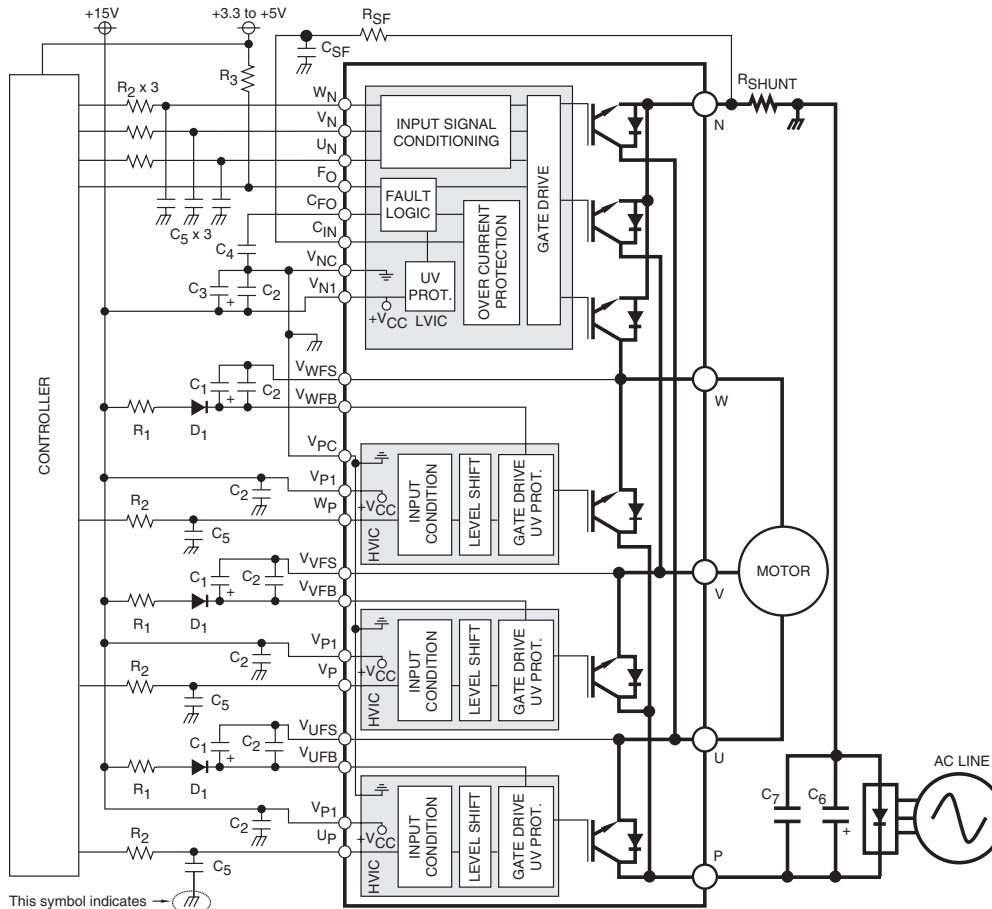

This symbol indicates connection to ground plane.

Component Selection:

Dsgn.	Typ. Value	Description
D1	1A, 600V	Boot strap supply diode – Ultra fast recovery
C1	10-100uF, 50V	Boot strap supply reservoir – Electrolytic, long life, low Impedance, 105°C (Note 5)
C2	0.22-2.0uF, 50V	Local decoupling/High frequency noise filters – Multilayer ceramic (Note 8)
C3	10-100uF, 50V	Control power supply filter – Electrolytic, long life, low Impedance, 105°C
C4	22nF, 50V	Fault lock-out timing capacitor – Multilayer ceramic (Note 4)
C5	100pF, 50V	Optional input signal noise filter – Multilayer ceramic (Note 1)
C6	200-2000uF, 450V	Main DC bus filter capacitor – Electrolytic, long life, high ripple current, 105°C
C7	0.1-0.22uF, 450V	Surge voltage suppression capacitor – Polyester/Polypropylene film (Note 9)
C_SF	1000pF, 50V	Short circuit detection filter capacitor – Multilayer Ceramic (Note 6, Note 7)
R_SF	1.8k ohm	Short circuit detection filter resistor (Note 6, Note 7)
R_SHUNT	5-100 mohm	Current sensing resistor - Non-inductive, temperature stable, tight tolerance (Note 10)
R1	10 ohm	Boot strap supply inrush limiting resistor (Note 5)
R2	330 ohm	Optional control input noise filter (Note 1, Note 2)
R3	10k ohm	Fault output signal pull-up resistor (Note 3)

Notes:

- 1) To prevent input signal oscillations minimize wiring length to controller (~2cm). Additional RC filtering (C5 etc.) may be required. If filtering is added be careful to maintain proper dead time. See application notes for details.
- 2) Internal HVIC provides high voltage level shifting allowing direct connection of all six driving signals to the controller.
- 3) F_O output is an open collector type. Pull up resistor (R3) should be adjusted to current sink capability of the module.
- 4) C4 sets the fault output duration and lock-out time. C4 $12.2E^{-6} \times t_{FO}$, 22nF gives ~1.8ms
- 5) Boot strap supply component values must be adjusted depending on the PWM frequency and technique.
- 6) Wiring length associated with R_{SHUNT}, R_{SF}, C_{SF} must be minimized to avoid improper operation of the SC function.
- 7) R_{SF}, C_{SF} set short-circuit protection trip time. Recommend time constant is 1.5us-2.0us. See application notes.
- 8) Local decoupling/high frequency filter capacitors must be connected as close as possible to the modules pins.
- 9) The length of the DC link wiring between C6, C7, the DIP's P terminal and the shunt must be minimized to prevent excessive transient voltages. In particular C7 should be mounted as close to the DIP as possible.
- 10) Use high quality, tight tolerance current sensing resistor. Connect resistor as close as possible to the DIP's N terminal. Be careful to check for proper power rating. See application notes for calculation of resistance value.