

HIGH ISOLATION VOLTAGE HIGH COLLECTOR TO EMITTER VOLTAGE DARLINGTON TYPE 6 PIN OPTOCOUPLER

PS2633
PS2633L
PS2634
PS2634L

FEATURES

- **HIGH ISOLATION VOLTAGE**
BV: 5 k Vr.m.s. MIN
- **HIGH COLLECTOR TO EMITTER VOLTAGE**
V_{CEO}: 300 V MIN
- **ULTRA HIGH CURRENT TRANSFER RATIO**
CTR: 1000% MIN
- **HIGH SPEED SWITCHING**
tr,tf = 100 μs TYP

DESCRIPTION

PS2633, PS2633L, PS2634, and PS2634L are optically coupled isolators containing a GaAs light emitting diode and an NPN silicon Darlington-connected phototransistor. PS2633 and PS2634 are in a plastic DIP (Dual In-Line Package). PS2633L and PS2634L are lead bending type (Gull-wing) for surface mount. PS2633 and PS2633L have a base pin and PS2634 and PS2634L have no base pin.

APPLICATIONS

- TELEPHONE/TELEGRAPH LINE RECEIVER
- POWER SUPPLY

ELECTRICAL CHARACTERISTICS (T_A = 25°C)

PART NUMBER				PS2633, PS2633L, PS2634, PS2634L		
	SYMBOLS	PARAMETERS	UNITS	MIN	TYP	MAX
Diode	V _F	Forward Voltage, I _F = 10 mA	V		1.15	1.4
	I _R	Reverse Current, V _R = 5 V	μA			5
	C	Junction Capacitance, V = 0, f = 1.0 MHz	pF		30	
Transistor	I _{CEO}	Collector to Emitter Dark Current V _{CE} = 300 V, I _F = 0	nA			400
	BV _{CEO}	Collector to Emitter Breakdown Voltage I _c = 1 mA, I _B = 0	V	300		
	BV _{EBO}	Emitter to Base Breakdown Voltage ¹ I _E = 100 μA, I _C = 0	V	6		
Coupled	CTR	Current Transfer Ratio, I _F = 1 mA, V _{CE} = 2 V	%	1000	4000	15000
	V _{CE(sat)}	Collector Saturation Voltage, I _F = 1 mA, I _C = 2 mA	V			1.0
	R ₁₋₂	Isolation Resistance, V _{in-out} = 1.0 k VDC	Ω	10 ¹¹		
	C ₁₋₂	Isolation Capacitance, V = 0, f = 1.0 MHz	pF		0.6	
	t _r	Rise Time ² , V _{CC} = 5 V, I _C = 10 mA	μs		100	
	t _f	Fall Time ² , V _{CC} = 5 V, I _C = 10 mA	μs		100	

1. Only PS2633, PS2633L

2. Test Circuit for Switching Time

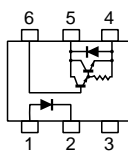

PS2633

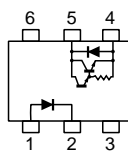

PS2634

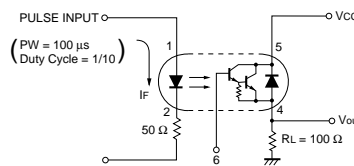

PS2633

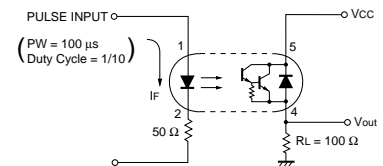

PS2634

PS2633, PS2633L, PS2634, PS2634L

ABSOLUTE MAXIMUM RATINGS¹ (T_A = 25°C)

SYMBOLS	PARAMETERS	UNITS	RATINGS
Diode			
V _R	Reverse Voltage	V	6
I _F	Forward Current (DC)	mA	80
P _D	Power Dissipation	mW	150
I _F (Peak)	Peak Forward Current PW = 100 μs, Duty Cycle 1%	A	1
Transistor			
V _{CEO}	Collector to Emitter Voltage	V	300
V _{EB0}	Emitter to Base Voltage ²	V	6
I _C	Collector Current	mA	150
P _C	Power Dissipation	mW	300
Coupled			
BV	Isolation Voltage ³	V _{r.m.s.}	5000
T _{STG}	Storage Temperature	°C	-55 to +150
T _{OP}	Operating Temperature	°C	-55 to +100

Notes:

1. Operation in excess of any one of these parameters may result in permanent damage.
2. Only PS2633, PS2633L
3. AC voltage for 1 minute at T_A = 25 °C, RH = 60 % between input (Pin No. 1, 2, 3 Common) and output (Pin No. 4, 5, 6 Common).

OUTLINE DIMENSIONS (Units in mm)

PS2633, PS2634

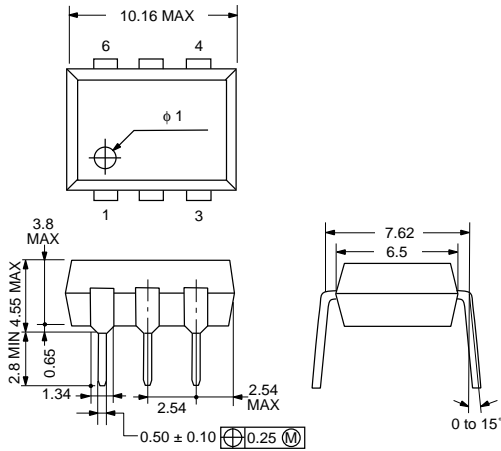

PS2633L, PS2634L

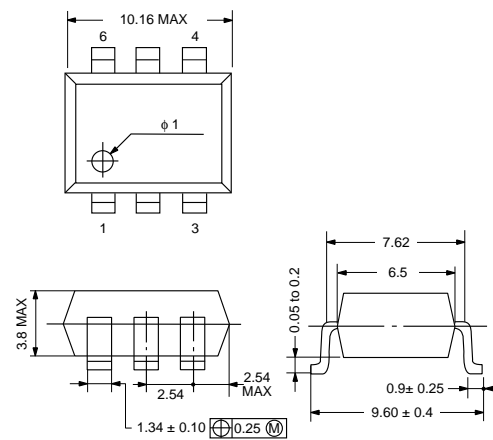

PIN CONNECTIONS (Top View)

PS2633, PS2633L

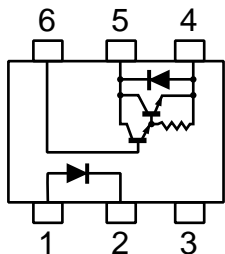

1. Anode
2. Cathode
3. NC
4. Emitter
5. Collector
6. Base

PS2634, PS2634L

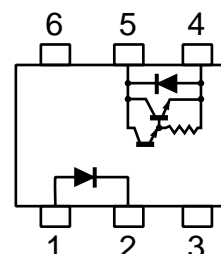

1. Anode
2. Cathode
3. NC
4. Emitter
5. Collector
6. NC

TYPICAL PERFORMANCE CURVES ($T_A = 25\text{ }^\circ\text{C}$)

DIODE POWER DISSIPATION vs. AMBIENT TEMPERATURE

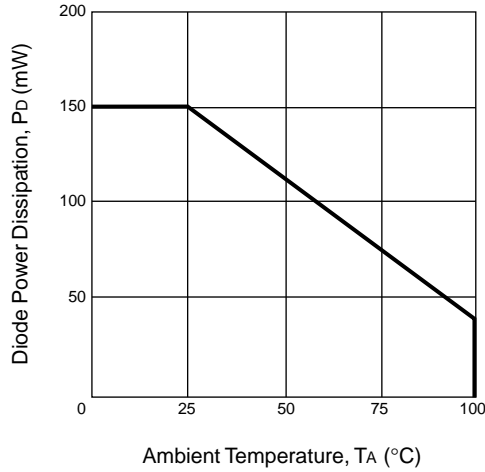

TRANSISTOR POWER DISSIPATION vs. AMBIENT TEMPERATURE

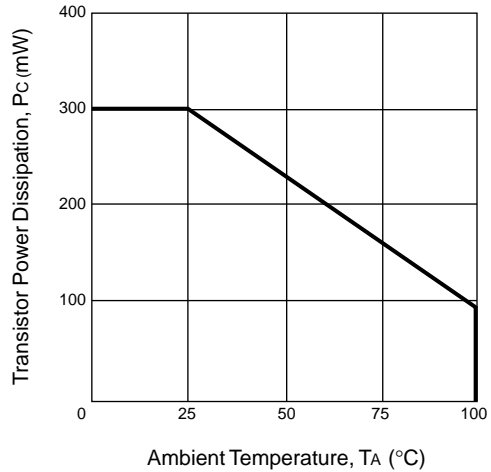

FORWARD CURRENT vs. FORWARD VOLTAGE

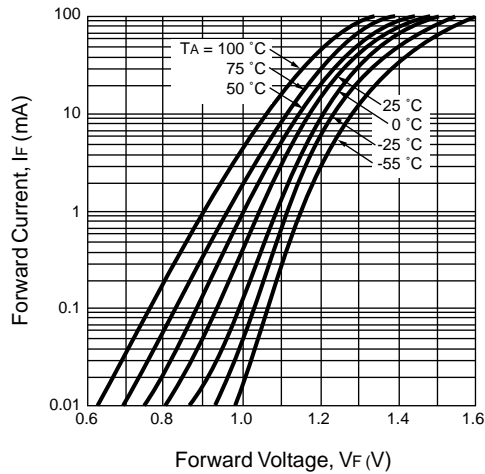

COLLECTOR CURRENT vs. COLLECTOR TO EMITTER VOLTAGE

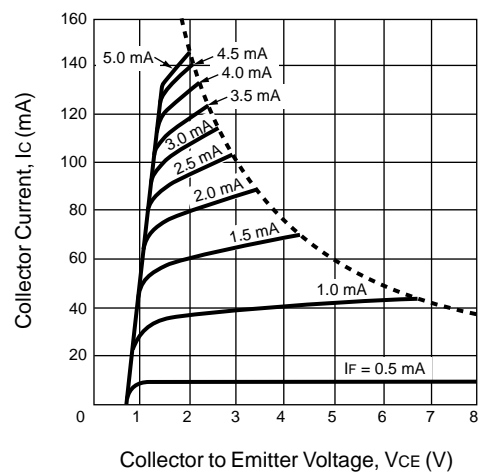

COLLECTOR TO EMITTER DARK CURRENT vs. AMBIENT TEMPERATURE

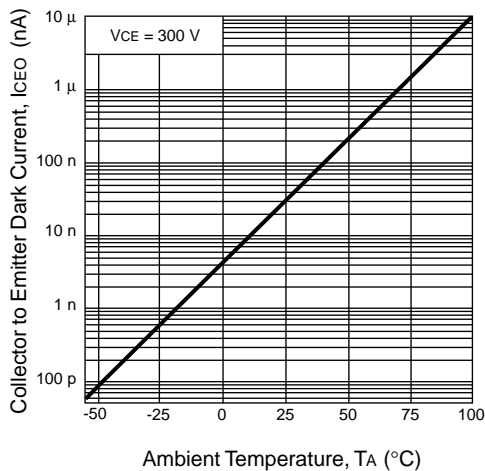

COLLECTOR CURRENT vs. COLLECTOR SATURATION VOLTAGE

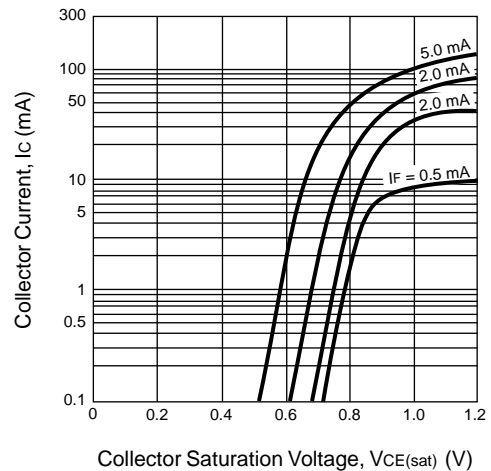

TYPICAL PERFORMANCE CURVES (TA = 25 °C)

