

8-PIN SOP SOLID STATE RELAY

PS7241-AT1
PS7241-AT5

FEATURES

- **2 CHANNEL TYPE:**
OCMOS FET + PHOTOCOUPLER
- **DESIGNED FOR AC/DC SWITCHING LINE CHANGER**
- **SMALL PACKAGE:**
8-PIN SOP
- **ISOLATION VOLTAGE:**
BV: 1500 Vr.m.s. MIN
- **LOW OFFSET VOLTAGE**
- **LOW LED OPERATING CURRENT:**
IF = 2 mA
- **AVAILABLE IN TAPE AND REEL**

DESCRIPTION

PS7241-AT1 and PS7241-AT5 are solid state relays containing a GaAs LED on the emitting side (input side) and MOSFETs (+ Phototransistor) on the output side. They are suitable for analog signal control because of their low offset and high linearity.

APPLICATIONS

- **EXCHANGE EQUIPMENT**
- **MEASUREMENT EQUIPMENT**
- **FA/OA EQUIPMENT**

ELECTRICAL CHARACTERISTICS (TA = 25°C)

		PART NUMBER				PS7241-AT1, PS7241-AT5		
		SYMBOLS	PARAMETERS	CONDITIONS	UNITS	MIN	TYP	MAX
OCMOS FET	Diode	V _F	Forward Voltage	I _F = 5 mA	V		1.2	1.4
		I _R	Reverse Current	V _R = 5 V	μA			5.0
	MOSFET	I _{LOFF}	Off-state Leakage Current	V _D = 400 V	μA		0.03	1.0
		C _{out}	Output Capacitance	V _D = 0 V, f = 1 MHz	pF		65	
	Coupler	I _{Fon}	LED On-state Current	I _L = 120 mA	mA			2.0
		R _{ON1}	On-state Resistance	I _F = 10 mA, I _L = 10 mA	Ω		20	30
				I _F = 10 mA, I _L = 120 mA, t _≤ 10 ms	Ω			25
		t _{ON}	Turn-on Time	I _F = 10 mA, V _O = 5 V, PW ≥10 ms	ms		0.3	1.0
		t _{OFF}	Turn-off Time		ms		0.04	0.2
		R _{I-O}	Isolation Resistance	V _{I-O} = 1.0 kV	Ω	10 ⁹		
	C _{I-O}	Isolation Capacitance	V = 0 V, f = 1 MHz	pF		1.1		
Photocoupler	Diode	V _F	Forward Voltage	I _F = 10 mA	V		1.2	1.4
		I _R	Reverse Current ¹	V _R = 5 V	μA			5.0
	Transistor	I _{CEO}	Collector to Emitter Dark Current	V _{CE} = 40 V, I _F = 0 mA	nA			100
		BV _{CEO}	Collector to Emitter Breakdown Voltage	I _C = 1 mA	V	40		
	Coupler	BV _{ECO}	Emitter to Collector Breakdown Voltage	I _E = 100 μA	V	6		
		CTR	Current Transfer Ratio	I _F = 5 mA, V _{CE} = 5 V	%	50		400
		V _{CE(sat)}	Collector Saturation Voltage	I _F = 10 mA, I _C = 2 mA	V			0.3
		R _{I-O}	Isolation Resistance	V _{in-out} = 1.0 kVcc	Ω	10 ¹¹		
		C _{I-O}	Isolation Capacitance	V = 0 V, f = 1 MHz	pF		0.4	
t _R	Rise Time	V _{CC} = 5 V, I _C = 2 mA	μs		3.0			
t _F	Fall Time	R _L = 100 Ω	μs		5.0			

Note:

1. PS7241-AT1 only.

ABSOLUTE MAXIMUM RATINGS¹ (T_A = 25°C)

www.DataSheet4U.com

	SYMBOLS	PARAMETERS	UNITS	RATINGS
OCMOS	Diode			
	I _F	Forward Current (DC)	mA	50
	V _R	Reverse Voltage	V	5.0
	P _D	Power Dissipation	mW/ch	50
	I _{FP}	Peak Forward Current ²	A	1.0
	MOSFET			
	V _L	Break Down Voltage	V	400
	I _L	Continuous Load Current	mA	120
	I _{LP}	Pulse Load Current ³ (AC/DC Connection)	mA	250
	P _D	Power Dissipation	mW	430
Photocoupler	Diode			
	I _F	Forward Current	mA	50
	V _R	Reverse Voltage ⁴	V	5.0
	P _D	Power Dissipation	mW/ch	50
	I _{FP}	Peak Forward Current ²	A	1.0
	Transistor			
	V _{CEO}	Collector to Emitter Voltage	V	40
	V _{ECO}	Emitter to Collector Voltage	V	6.0
	I _C	Collector Current	mA	80
	P _C	Power Dissipation	mW	100
BV	Isolation Voltage ⁵	Vr.m.s.	1500	
P _T	Total Power Dissipation	mW	630	
T _A	Operating Ambient Temp.	°C	-40 to 80	
T _{STG}	Storage Temperature	°C	-40 to 100	

RECOMMENDED OPERATING CONDITIONS (T_A = 25°C)

SYMBOLS	PARAMETERS	UNITS	MIN	TYP	MAX
OCMOS FET					
I _F	LED Operating Current	mA	2	10	20
V _F	LED Off Voltage	V	0		0.5

ORDERING INFORMATION

PART NUMBER	PACKAGE	PACKING STYLE
PS7241-AT1	8-pin SOP	Magazine case 45 pcs
PS7241-AT1-F3		Embossed Tape 1500 pcs/reel
PS7241-AT1-F4		
PS7241-AT5	8-pin SOP	Magazine case 45 pcs
PS7241-AT5-F3		Embossed Tape 1500 pcs/reel
PS7241-AT5-F4		

Notes:

1. Operation in excess of any one of these parameters may result in permanent damage.
2. PW = 100 μs, Duty Cycle = 1%.
3. PW = 100 ms, 1 shot.
4. PS7241-AT1 only.
5. AC voltage for 1 minute at T_A = 25 °C, RH = 60 % between input and output.

OUTLINE DIMENSIONS (Units in mm)

PS7241-AT1

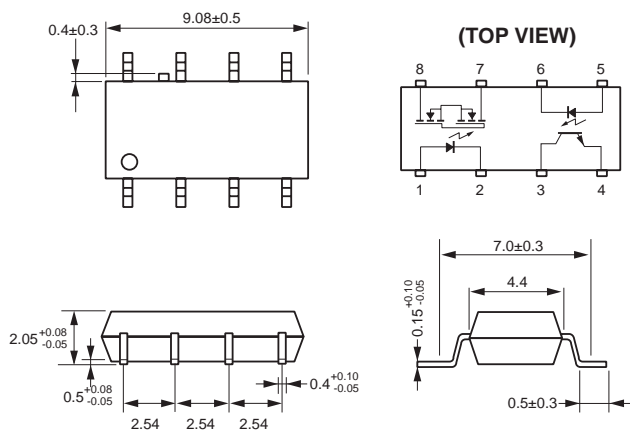

- 1 LED Anode
- 2 LED Cathode
- 3 Tr Collector
- 4 Tr Emitter
- 5 LED Anode
- 6 LED Cathode
- 7 MOSFET
- 8 MOSFET

PS7241-AT5

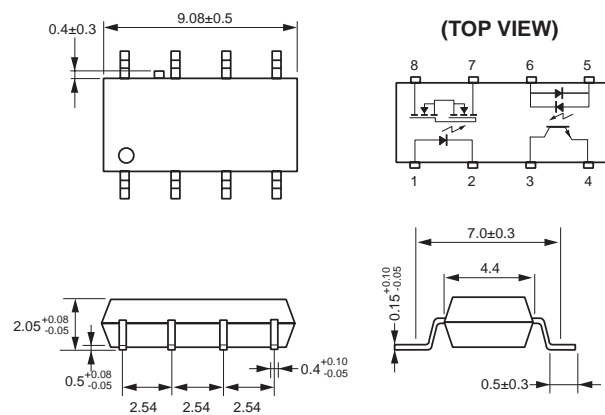

- 1 LED Anode
- 2 LED Cathode
- Tr Collector
- Tr Emitter
- LED Anode/Cathode
- LED Cathode/Anode
- MOSFET
- MOSFET

OCMOS TYPICAL PERFORMANCE CURVES (TA = 25°C)

www.DataSheet4U.com

MAXIMUM FORWARD CURRENT (DC)
vs. AMBIENT TEMPERATURE

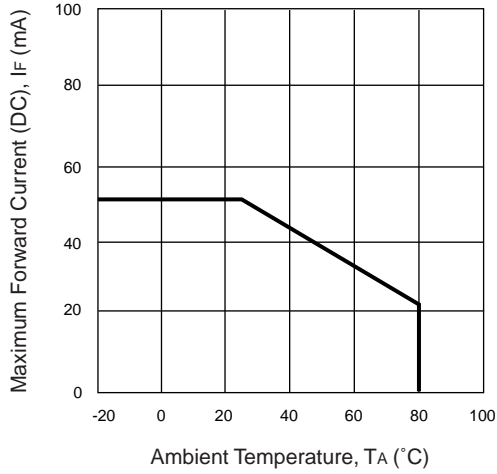

MAXIMUM LOAD CURRENT
vs. AMBIENT TEMPERATURE

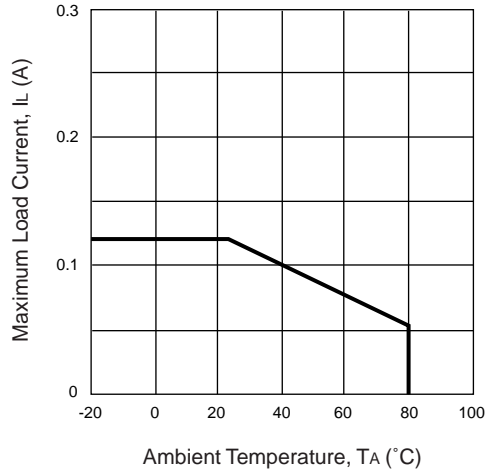

FORWARD VOLTAGE vs.
AMBIENT TEMPERATURE

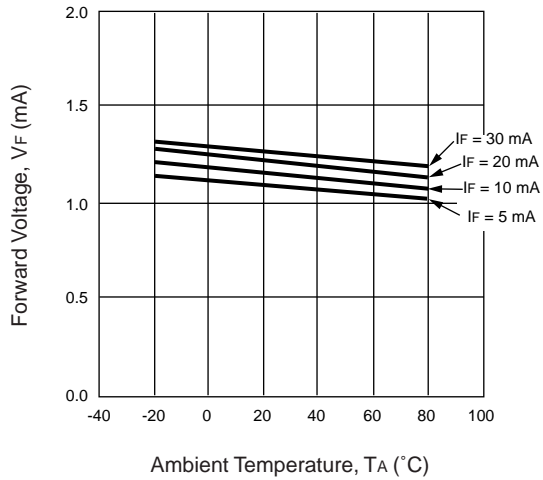

OUTPUT CAPACITANCE
vs. SUPPLY VOLTAGE

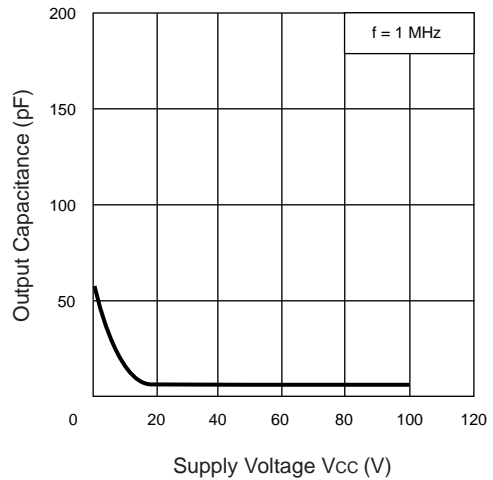

OFF-STATE LEAKAGE CURRENT
vs. SUPPLY VOLTAGE

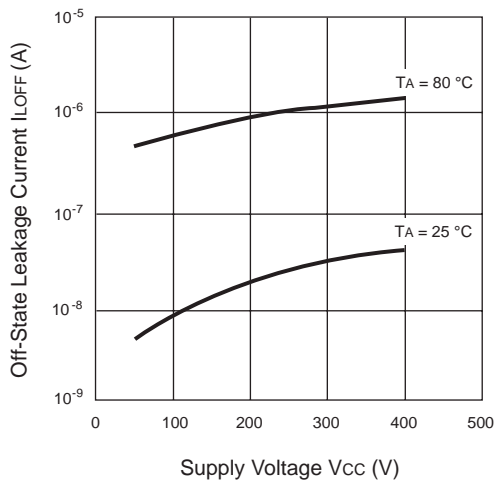

LOAD CURRENT vs.
LOAD VOLTAGE

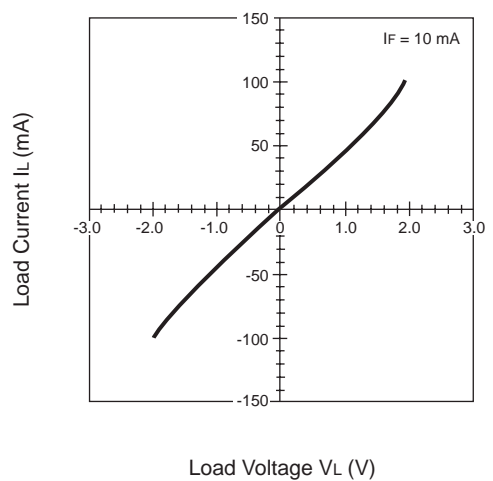

OCMOS TYPICAL PERFORMANCE CURVES (TA = 25°C)

www.DataSheet4U.com

NORMALIZED ON-STATE RESISTANCE vs. AMBIENT TEMPERATURE

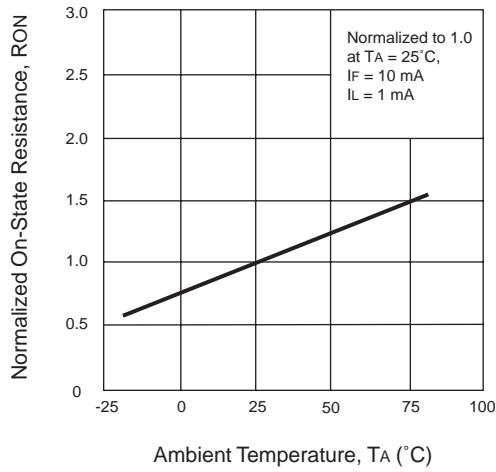

ON-STATE RESISTANCE DISTRIBUTION

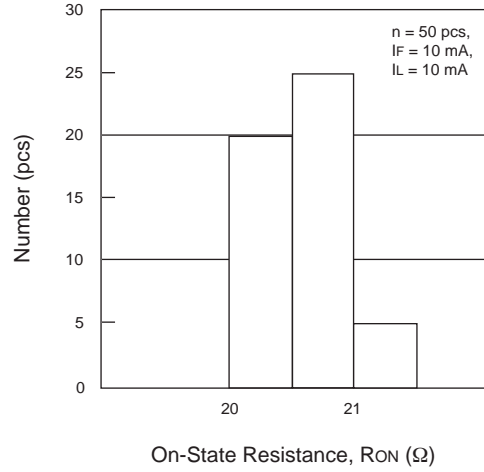

TURN-ON TIME vs. FORWARD CURRENT

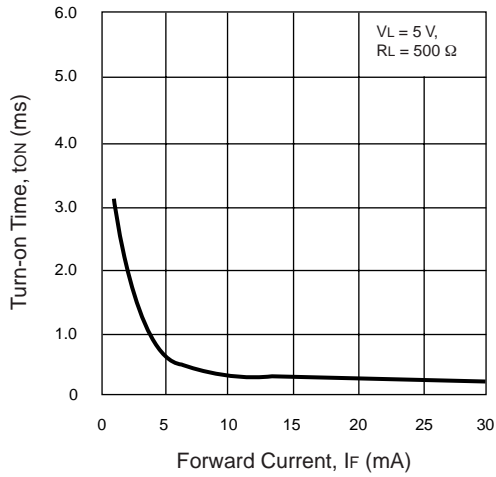

TURN-OFF TIME vs. FORWARD CURRENT

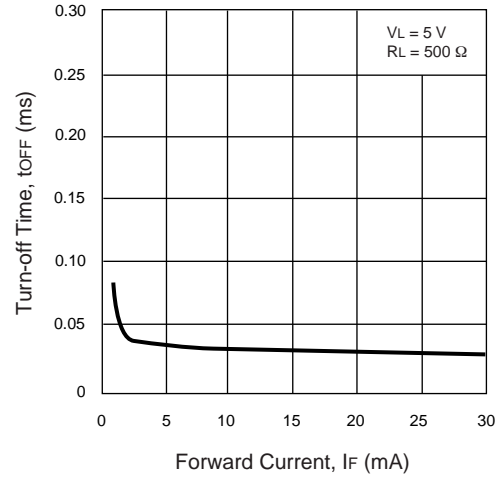

TURN-ON TIME DISTRIBUTION

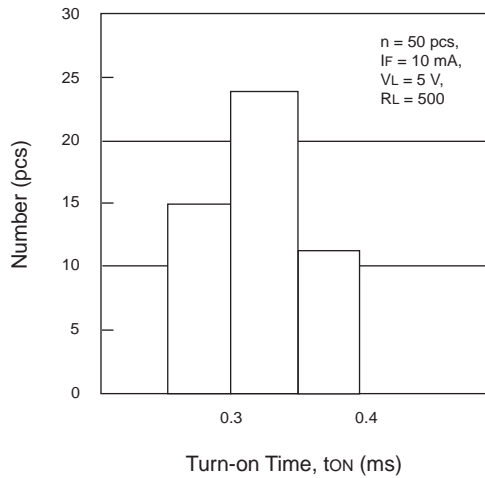

TURN-OFF TIME DISTRIBUTION

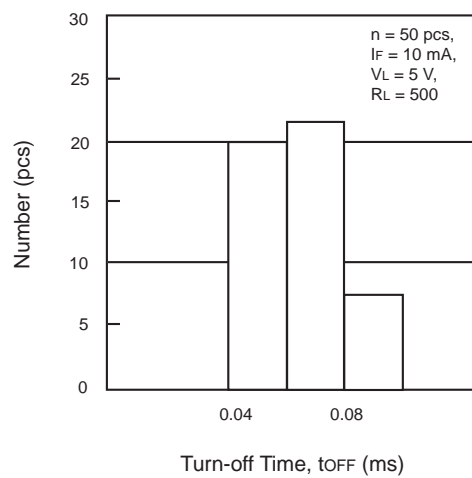

OCMOS TYPICAL PERFORMANCE CURVES (TA = 25°C)

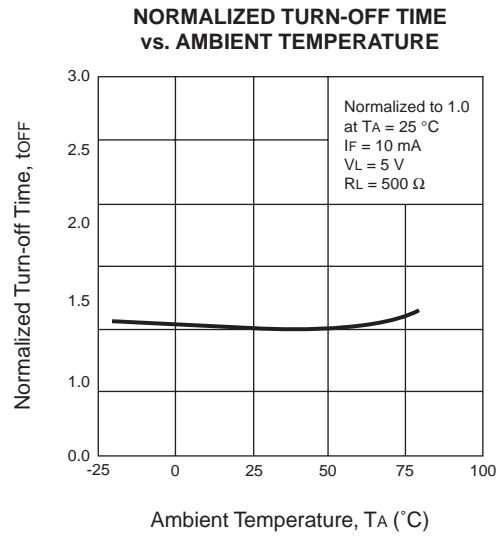
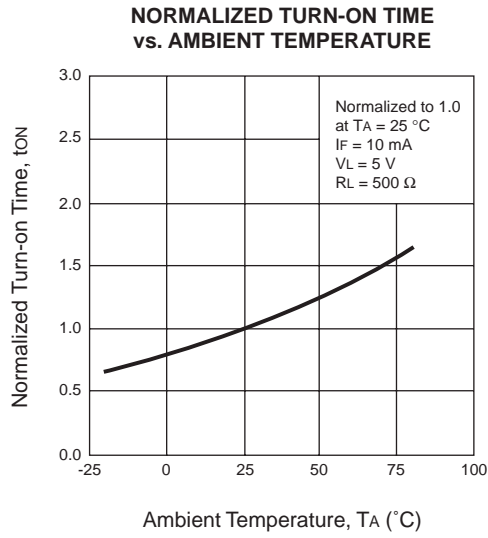

PHOTOCOUPLER TYPICAL PERFORMANCE CURVES (TA = 25°C)

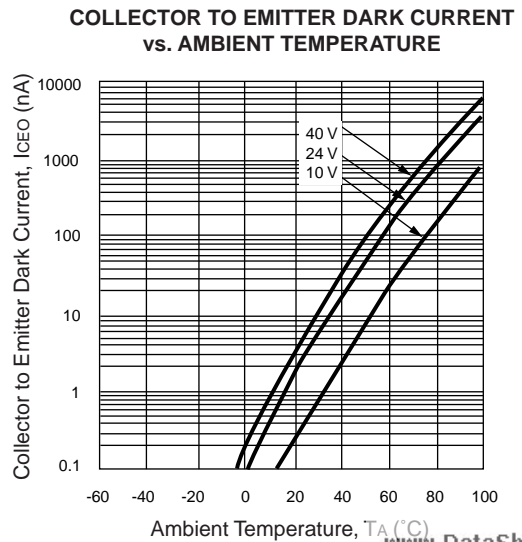
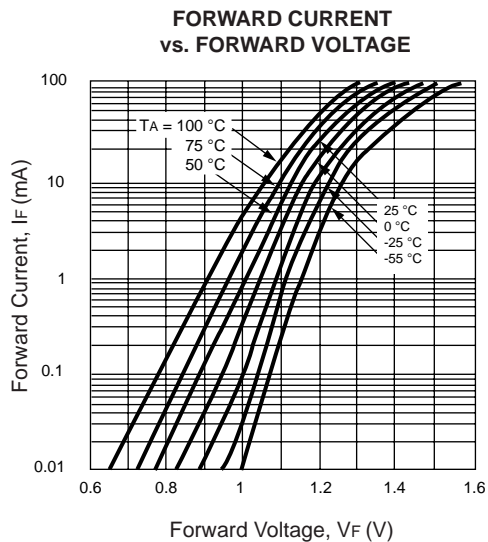
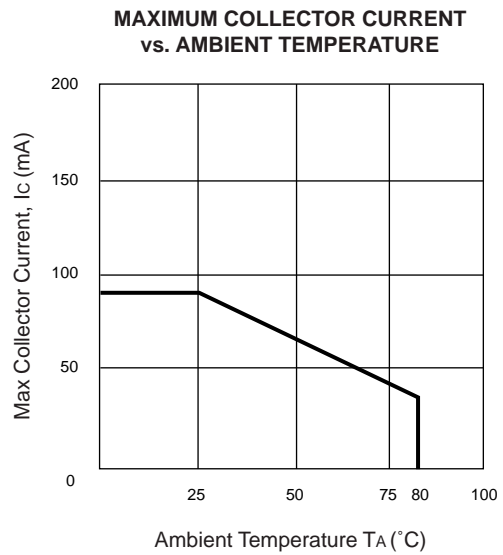
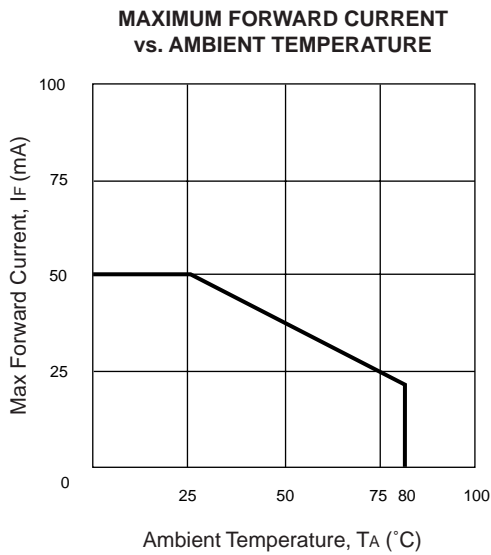

PHOTOCOUPLER TYPICAL PERFORMANCE CURVES (TA = 25°C)

www.DataSheet4U.com

COLLECTOR CURRENT vs. COLLECTOR SATURATION VOLTAGE

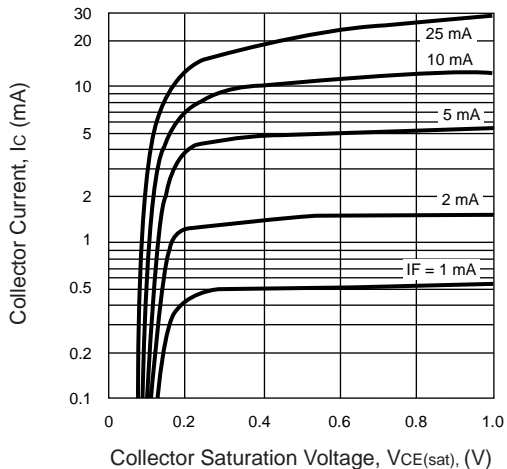

COLLECTOR CURRENT vs. COLLECTOR TO EMITTER VOLTAGE

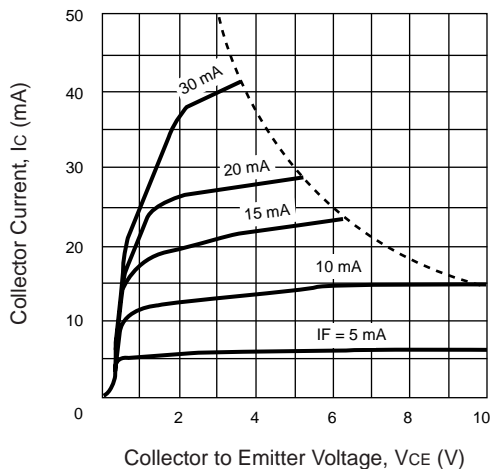

NORMALIZED OUTPUT CURRENT vs. AMBIENT TEMPERATURE

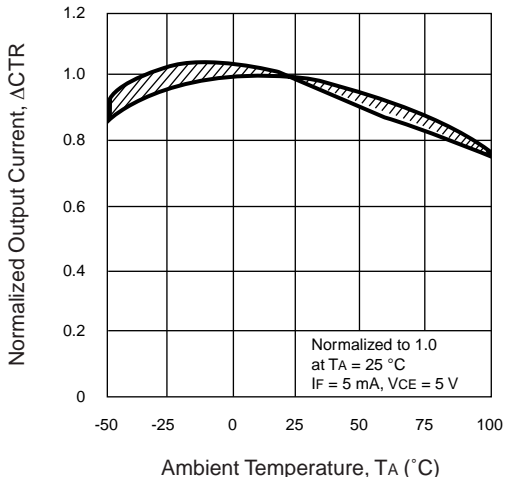

CURRENT TRANSFER RATIO (CTR) vs. FORWARD CURRENT

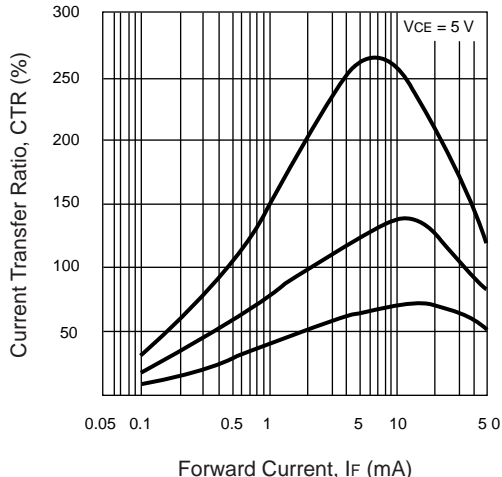

SWITCHING TIME vs. LOAD RESISTANCE

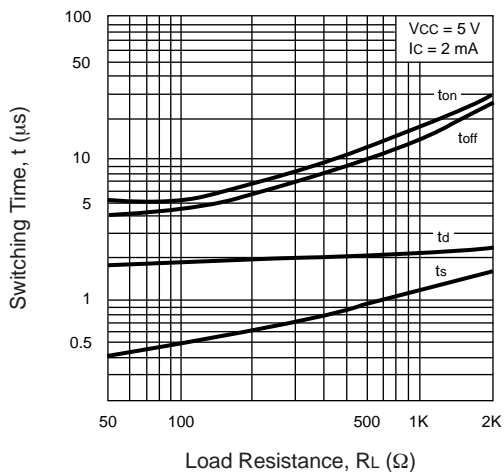

SWITCHING TIME vs. LOAD RESISTANCE

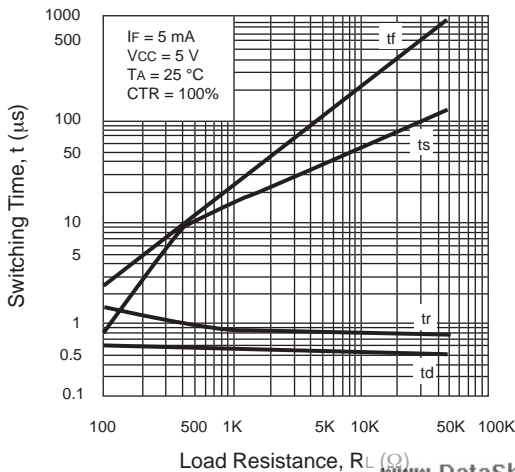

TAPING SPECIFICATIONS (Units in mm)

www.DataSheet4U.com

OUTLINE AND DIMENSIONS (TAPE)

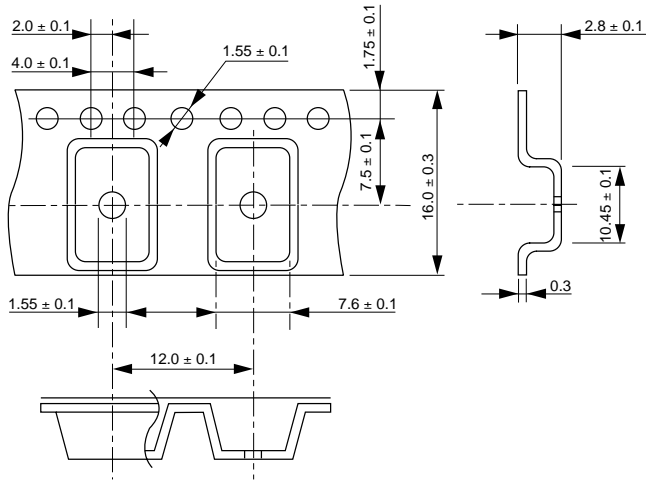

OUTLINE AND DIMENSIONS (REEL)

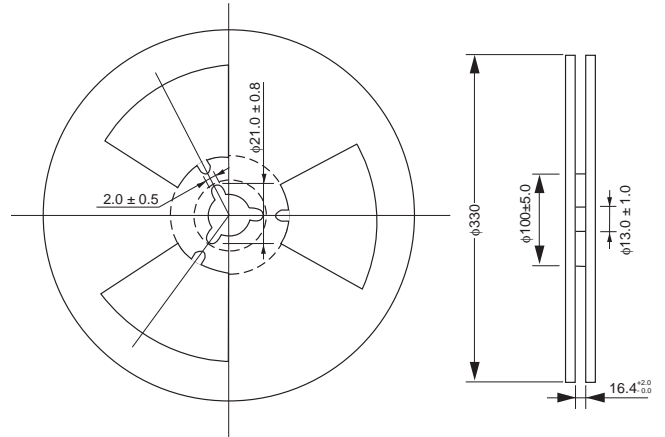

Notes:
1. Packaging : 1500 pcs/reel

TAPING DIRECTION

PS7241-AT1-F3
PS7241-AT5-F3

PS7241-AT1-F4
PS7241-AT5-F4

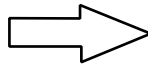
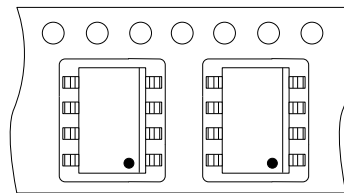
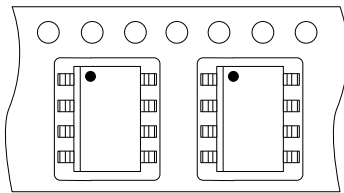

RECOMMENDED SOLDERING CONDITIONS

www.DataSheet4U.com

(1) Infrared reflow soldering

- Peak reflow temperature 235 °C or below (package surface temperature)
- Time of temperature higher than 210 °C 30 seconds or less
- Number of reflows Two
- Flux Rosin flux containing small amount of chlorine
(The flux with a maximum chlorine content of 0.2 Wt % is recommended.)

Recommended Temperature Profile of Infrared Reflow

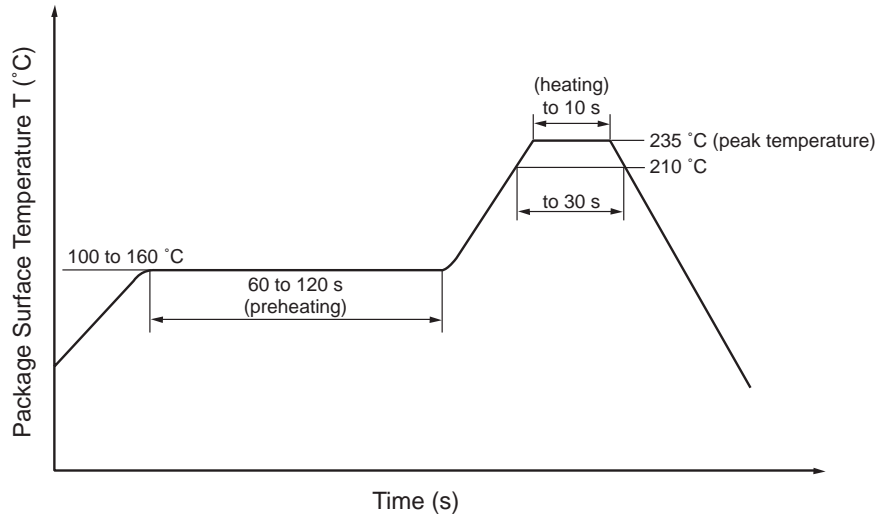

(2) Dip soldering

- Temperature 260 °C or below (molten solder temperature)
- Time 10 seconds or less
- Number of times One
- Flux Rosin flux containing small amount of chlorine
(The flux with a maximum chlorine content of 0.2 Wt % is recommended.)

(3) Cautions

- Fluxes
Avoid removing the residual flux with freon-based cleaning solvent.
- Avoid shorting between portion of frame and leads.

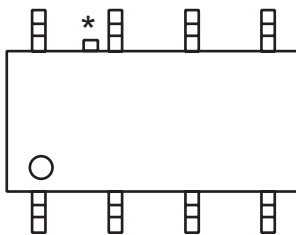

* Portion of frame

EXCLUSIVE NORTH AMERICAN AGENT FOR **NEC** RF, MICROWAVE & OPTOELECTRONIC SEMICONDUCTORS

CEL CALIFORNIA EASTERN LABORATORIES • Headquarters • 4590 Patrick Henry Drive • Santa Clara, CA 95054-1817 • (408) 988-3500 • Telex 34-6393 • FAX (408) 988-0279
DATA SUBJECT TO CHANGE WITHOUT NOTICE

Internet: <http://WWW.CEL.COM>

www.DataSheet4U.com