

### 1. PART NO. EXPRESSION :

PSB06051R2MZ F

(a) (b) (c) (d)(e)(f)

(a) Series code

(b) Dimension code

(c) Inductance code : 1R2 = 1.2uH

(d) Tolerance code : K =  $\pm 10\%$ , M =  $\pm 20\%$

(e) X, Y, Z : Standard part

(f) F : Lead Free

### 2. CONFIGURATION & DIMENSIONS :

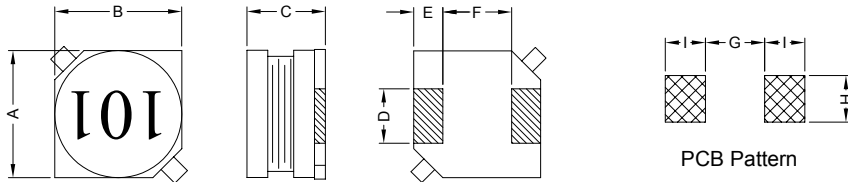

Unit:m/m

A	B	C	D	E	F	G	H	I
6.0 $\pm$ 0.3	6.0 $\pm$ 0.3	4.9 $\pm$ 0.3	2.0 $\pm$ 0.2	1.5 $\pm$ 0.2	3.0 $\pm$ 0.2	2.8 Ref.	2.2 Ref.	1.9 Ref.

### 3. SCHEMATIC :

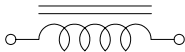

### 4. MATERIALS :

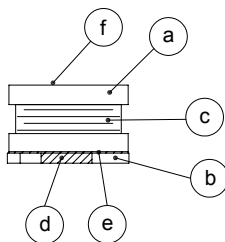

(a) Core : DR Ferrite Core

(b) Base : LCP

(c) Wire : Enamelled Copper Wire

(d) Terminal : Tinned Copper Plate

(e) Adhesive : Epoxy

(f) Ink : Bon Margue

### 5. GENERAL SPECIFICATION :

- a) Temp. rise : 40°C Max.
- b) Rated current : Base on temp. rise &  $\Delta L/L0A = 10\%$  Max.
- c) Storage temp. : -40°C to +125°C
- d) Operating temp. : -40°C to +85°C
- e) Resistance to solder heat : 260°C.10 secs



## 6. ELECTRICAL CHARACTERISTICS :

Part No.	Inductance ( $\mu$ H)	Test Frequency (Hz)	RDC ( $m\Omega$ ) Max.	IDC (A) Max.
PSB06051R2MZF	1.2 $\pm$ 20%	1V / 100K	28	3.50
PSB06051R5MZF	1.5 $\pm$ 20%	1V / 100K	30	3.00
PSB06052R2MZF	2.2 $\pm$ 20%	1V / 100K	35	2.70
PSB06053R3MZF	3.3 $\pm$ 20%	1V / 100K	42	2.50
PSB06054R7MZF	4.7 $\pm$ 20%	1V / 100K	50	2.20
PSB06056R8MZF	6.8 $\pm$ 20%	1V / 100K	60	2.00
PSB0605100MZF	10.0 $\pm$ 20%	1V / 100K	70	1.80
PSB0605120MZF	12.0 $\pm$ 20%	1V / 100K	80	1.60
PSB0605150MZF	15.0 $\pm$ 20%	1V / 100K	90	1.50
PSB0605180MZF	18.0 $\pm$ 20%	1V / 100K	95	1.30
PSB0605220MZF	22.0 $\pm$ 20%	1V / 100K	110	1.20
PSB0605270MZF	27.0 $\pm$ 20%	1V / 100K	130	1.10
PSB0605330KZF	33.0 $\pm$ 10%	1V / 100K	180	1.00
PSB0605390KZF	39.0 $\pm$ 10%	1V / 100K	210	0.90
PSB0605470KZF	47.0 $\pm$ 10%	1V / 100K	220	0.80
PSB0605560KZF	56.0 $\pm$ 10%	1V / 100K	250	0.75
PSB0605680KZF	68.0 $\pm$ 10%	1V / 100K	300	0.70
PSB0605820KZF	82.0 $\pm$ 10%	1V / 100K	390	0.60
PSB0605101KZF	100.0 $\pm$ 10%	1V / 100K	430	0.55
PSB0605121KZF	120.0 $\pm$ 10%	1V / 100K	500	0.50
PSB0605151KZF	150.0 $\pm$ 10%	1V / 100K	620	0.45
PSB0605181KZF	180.0 $\pm$ 10%	1V / 100K	690	0.40
PSB0605221KZF	220.0 $\pm$ 10%	1V / 100K	890	0.38
PSB0605271KZF	270.0 $\pm$ 10%	1V / 100K	1000	0.35
PSB0605331KZF	330.0 $\pm$ 10%	1V / 100K	1400	0.32
PSB0605391KZF	390.0 $\pm$ 10%	1V / 100K	1500	0.30
PSB0605471KZF	470.0 $\pm$ 10%	1V / 100K	2000	0.28
PSB0605561KZF	560.0 $\pm$ 10%	1V / 100K	2300	0.25
PSB0605681KZF	680.0 $\pm$ 10%	1V / 100K	3200	0.20
PSB0605821KZF	820.0 $\pm$ 10%	1V / 100K	3500	0.18
PSB0605102KZF	1000.0 $\pm$ 10%	1V / 100K	4100	0.16



## 7. CHARACTERISTICS CURVES :

@ TEMP. RISE VS. DC SUPERPOSITION RESPONSE CURVE

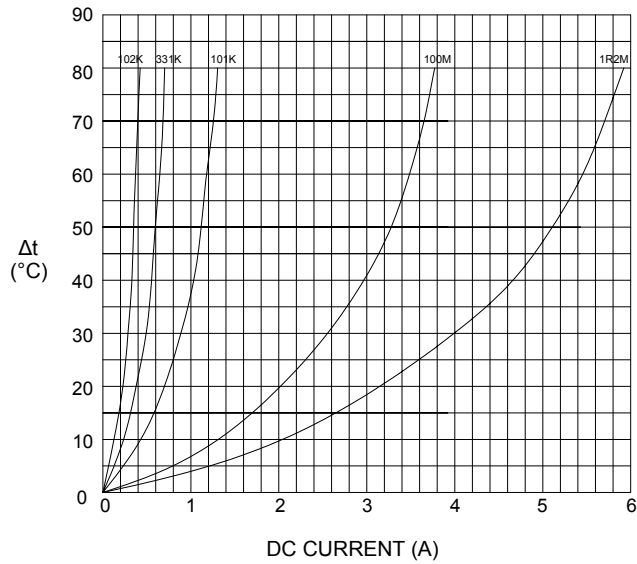

@ INDUCTANCE VS. FREQUENCY RESPONSE CURVE

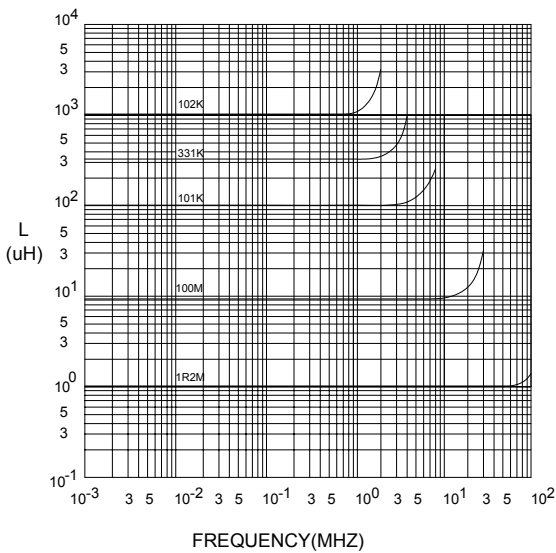

@ INDUCTANCE VS. DC SUPERPOSITION RESPONSE CURVE

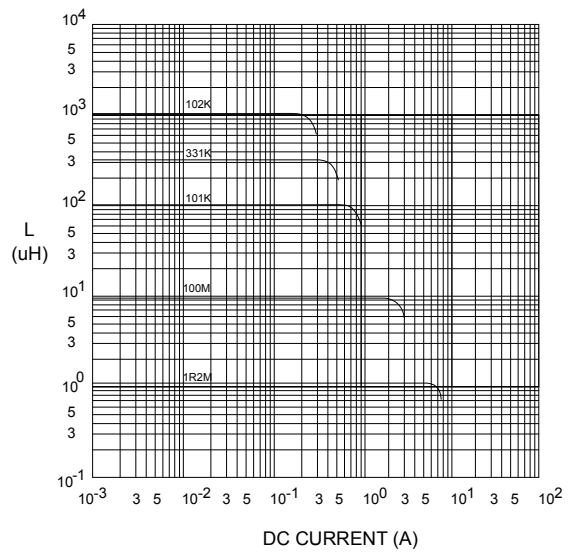

### RECOMMENDED SOLDERING CONDITIONS REFLOW SOLDERINGS

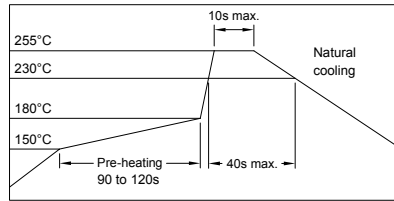

### 8. PACKAGING INFORMATION :

#### ( 1 ) CONFIGURATION

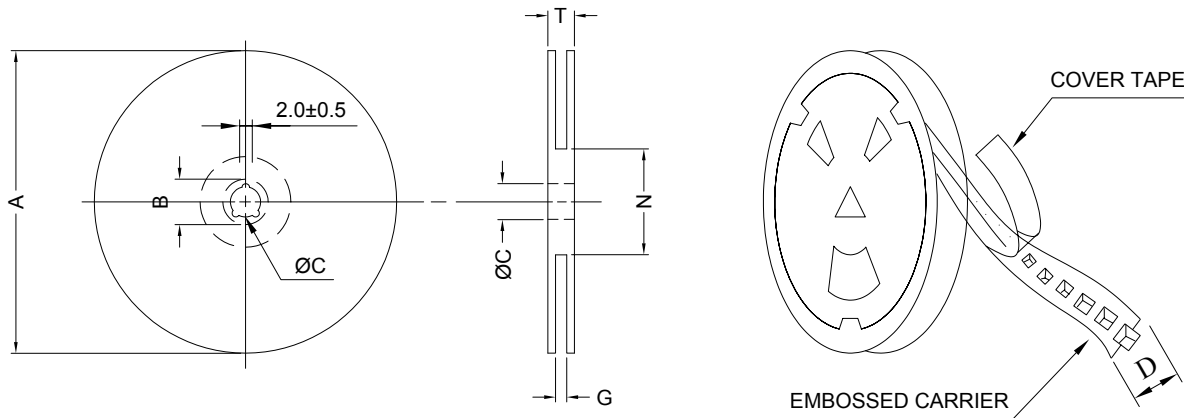

\* CARRIER TAPE WIDTH : D

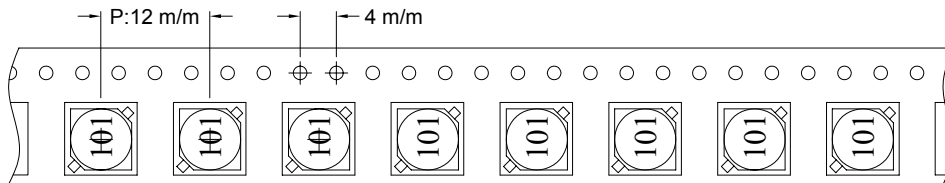

#### ( 2 ) DIMENSIONS

Unit:m/m

STYLE	A	B	C	D	G	N	T
13-16	330	21±0.8	13	16	18 <sup>+0</sup>	50 <sup>-0</sup>	22.4

#### ( 3 ) Q'TY & G.W. PER PACKAGE

SERIES	INNER : REEL			OUTER : CARTON		
	Q'TY (PCS)	G.W. (gw)	STYLE	Q'TY (PCS)	G.W. (Kg)	SIZE (cm)
PSB0605	1000	700	13-16	6000	7.7	40 x 40 x 24

www.DataSheet4U.com



**RoHS Compliant**

NOTE : Specifications subject to change without notice. Please check our website for latest information.

05.05.2008



**SUPERWORLD ELECTRONICS (S) PTE LTD**

PG. 4

www.DataSheet4U.com

### 9. RELIABILITY AND TEST CONDITION :

TEST ITEM	SPECIFICATION	TEST CONDITION
SOLDERABILITY	MORE THAN 90% OF THE TERMINAL ELECTRODE SHALL BE COVERED WITH FRESH SOLDER.	PREHEAT : 125±25°C FOR 60 SECONDS SOLDER : 99%Sn/0.3%Ag/0.7%Cu OR EQUIVALENT SOLDER TEMP. : 245±5°C FLUX : ROSIN DIP TIME : 4±1 SECONDS
THERMAL SHOCK TEST  ( TEMP. CYCLE )	INDUCTANCE SHALL NOT CHANGE MORE THAN ±20%	ROOM TEMP. → -25±2°C 15 MINUTES → 30 MINUTES  ROOM TEMP. → 85±2°C 15 MINUTES → 30 MINUTES  TOTAL : 50 CYCLES
HUMIDITY RESISTANCE TEST		TEMPERATURE : 40±2°C HUMIDITY : 90 ~ 95% APPLIED CURRENT : PER SPEC. TIME : 500 HOURS
HIGH TEMP. RESISTANCE TEST		TEMPERATURE : 85±2°C APPLIED CURRENT : PER SPEC. TIME : 500 HOURS



**10. UL CARD :**

**OBMW2** **November 30, 2000**  
**Magnet Wire - Component**

**PACIFIC ELECTRIC WIRE & CABLE (SHENZHEN) CO LTD** **E201757**  
 607 BAOLONG INDUSTRIAL ESTATE LONGGANG, SHENZHEN  
 GUANGDONG CHINA

Mtl Dsg	Coating Type	TC	ANSI Type	TI
UEW/U	BC <b>Polyurethane</b>	—	—	<b>130</b>
PEW/U	<b>Polyester</b>	—	<b>MW5-C</b>	<b>155°C</b>
PEWH/U	<b>Modified Polyester</b>	—	<b>MW30-C</b>	<b>180</b>
PEW-NY/U	<b>Polyester</b>	<b>Polyamide</b>	<b>MW24-C</b>	<b>155</b>
HAI/U	<b>Polyester(Amide)(Imide)</b>	<b>Polyamideimide</b>	<b>MW35,73</b>	<b>200</b>
UEW-NY/U	<b>Polyurethane</b>	<b>Polyamide</b>	<b>MW80-C</b>	<b>155</b>
			<b>MW28-C</b>	<b>130</b>

**Marking: Company name and material designation or marked designation on package or reel, and Recognized Component Mark.**

**See General Information Preceding These Recognitions**

**1/3/2001** **Underwriters Laboratories Inc.** **Card 1 of 2**

**SUMITOMO CHEMICAL CO LTD** **E54705 (M)**  
 5-33 KITAHAMA 4-CHOME CHUO-KO, OSAKA JAPAN

Mtl Dsg	Col	Min Thk mm	UL94 Flame Class	Elec	RTI		H W I	H A I	H V T R	D 4 5	C T I
					with Imp	Mech w/o Imp					
Liquid crystal polyester (LCP), designated "EKONOL" or "SUMIKASUPER", furnished in the form of pellets, (Contd)											
E4008 , E400X	NC , BK	0.30	94V-0	130	130	130	—	—	—	—	—
		0.75	94V-0	130	130	130	3	4	—	—	—
		1.5	94V-0	130	130	130	2	4	—	—	—
		3.0	94V-0	130	130	130	1	4	0	5	4
E4008	NC , WT , BK	0.30	94V-0	130	130	130	—	—	—	—	—
		0.75	94V-0	220	180	220	3	4	—	—	—
		1.5	94V-0	220	200	240	2	4	—	—	—
		3.0	94V-0	220	200	240	1	4	0	5	4
E4010	NC , BK	0.30	94V-0	130	130	130	—	—	—	—	—
		0.75	94V-0	220	180	220	3	4	—	—	—
		1.5	94V-0	220	200	240	2	4	—	—	—
		3.0	94V-0	220	200	240	1	4	0	5	4
E400(Y)L , E4008L	NC , BK	0.30	94V-0	130	130	130	—	—	—	—	—
		0.75	94V-0	130	130	130	3	4	—	—	—
		1.5	94V-0	130	130	130	2	4	—	—	—
		3.0	94V-0	130	130	130	1	4	0	5	4
E4810	NC , BK	0.30	94V-0	130	130	130	—	—	—	—	—
		0.75	94V-0	130	130	130	0	4	—	—	—
		1.5	94V-0	130	130	130	0	4	—	—	—
		3.0	94V-0	130	130	130	1	4	0	5	4

**(X) Denotes any number 1 thru 9.**  
**(Y) Denotes any number 1 thru 7.**



**RoHS Compliant**

NOTE : Specifications subject to change without notice. Please check our website for latest information.

05.05.2008



**SUPERWORLD ELECTRONICS (S) PTE LTD**