

INNOLUX DISPLAY CORPORATION

LCD MODULE

SPECIFICATION

Customer: _____

Model Name: PT035TN01 V.6

SPEC NO.: P035-01-TT-63



Date: 2007/01/17

Version: 03

- Preliminary Specification
 Final Specification

For Customer's Acceptance

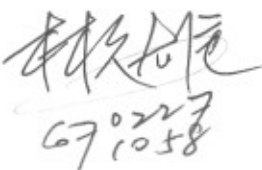
Approved by	Comment

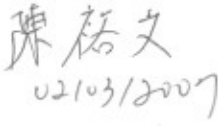
Approved by	Reviewed by	Prepared by
 陳國 070227 850169	 陳國 2/7/07	 陳國文 02103/2007

Record of Revision

Version	Revise Date	Page	Content
Final Spec. 01	2006/05/10		
02	2006/07/25	6	Modify the power sequence.
		15	Modify Terminal Resistance of Electrical Characteristics about Touch Screen.
		15	Modify Activation force of Mechanical & Reliability Characteristics about Touch Screen
03	2007/01/17	5	Add absolute ratings of environment
		7	Add note to power sequence
		9	Modify backlight driving condition
		10	Modify typ. value of CLKIN clock time from 88 to 98
			Modify min & typ. Values of HSD period time from 60 63.56 to 33.3 35.7
		12	Modify CLKIN frequency & cycle time
			Modify 3-wire serial communication AC timing
		14	Modify total lines from 263 to 467
			Modify total area from 408 to 364
		19	Modify color chromaticity
		21	Modify note 6
		23	Add Note 4, 5

Contents:

1. General Specifications	1
2. Pin Assignment	2
3. Operation Specifications	5
3.1. Absolute Ratings of Environment	5
3.2. Electrical Absolute Maximum Ratings	6
3.3. Power Sequence	7
3.4. Electrical Characteristics	8
3.4.1. Typical Operation Conditions	8
3.4.2. Current Consumption	9
3.4.3. Backlight Driving Condition	9
3.5. Timing Characteristics	10
3.5.1. AC Electrical Characteristics	10
3.5.2. Timing Diagram	13
4. Touch Screen Panel Specifications	16
4.1. Electrical Characteristics	16
4.2. Mechanical & Reliability Characteristics	16
4.3. Touch Screen Panel Block	17
4.4. Touch Screen Panel Pin Definition	18
5. Optical Specifications	19
6. Reliability Test Items	23
7. Handling Precautions	24
7.1. Safety	24
7.2. Handling	24
7.3. Static Electricity	24
7.4. Storage	24
7.5. Cleaning	24
8. Mechanical Drawing	25
9. Package Drawing	26
9.1. Packaging Material Table	26
9.2. Packaging Quantity	26
9.3. Packaging Drawing	27

1. General Specifications

No.	Item	Specification	Remark
1	LCD size	3.5" inch	
2	Driver element	a-Si TFT active matrix	
3	Resolution	320X3(RGB)X240	
4	Display mode	Normally White, Transmissive with Micro Reflective	
5	Dot pitch	0.073(W)X0.219(H) mm	
6	Active area	70.08(W)X52.56(H) mm	
7	Module size	78.2(W)X65.0(H)X4.6(D) mm	Note 1
8	Surface treatment	Anti-glare	
9	Color arrangement	RGB-stripe	
10	Interface	Digital	
11	Backlight power consumption	0.396W(Typ.)	
12	Panel power consumption	44mW(Typ.)	
13	Weight	44g (Typ.)	

Note 1: Refer to Mechanical Drawing.

2. Pin Assignment

FPC connector is used for the module electronics interface. The recommended model is “FH28-60S-0.5SH(05)” manufactured by Hirose.

Pin No.	Symbol	I/O	Function	Remark
1	GLED	P	GND for LED	
2	GLED	P	GND for LED	
3	VLED	P	Power for LED	
4	VLED	P	Power for LED	
5	GND	P	Ground	
6	X1	I	X_Right	
7	Y1	I	Y_Bottom	
8	X2	I	X_Left	
9	Y2	I	Y_Up	
10	GND	P	Ground	
11	NC	-	No connect	
12	NC	-	No connect	
13	POL	O	Polarity select for the line inversion control signal.	
14	RESET	I	Reset	
15	SPENA	I	Serial port data enable signal. Normally pull high.	
16	SPCK	I	Serial port clock .Normally pull high.	
17	SPDA	I/O	Serial port data input/output.	
18	D00	I	Data 00	Note2
19	D01	I	Data 01	Note2
20	D02	I	Data 02	Note2
21	D03	I	Data 03	Note2
22	D04	I	Data 04	Note2

23	D05	I	Data 05	Note2
24	D06	I	Data 06	Note2
25	D07	I	Data 07	Note2
26	D08	I	Data 08	Note2
27	D09	I	Data 09	Note2
28	D10	I	Data 10	Note2
29	D11	I	Data 11	Note2
30	D12	I	Data 12	Note2
31	D13	I	Data 13	Note2
32	D14	I	Data 14	Note2
33	D15	I	Data 15	Note2
34	D16	I	Data 16	Note2
35	D17	I	Data 17	Note2
36	D18	I	Data 18	Note2
37	D19	I	Data 19	Note2
38	D20	I	Data 20	Note2
39	D21	I	Data 21	Note2
40	D22	I	Data 22	Note2
41	D23	I	Data 23	Note2
42	IHS	I	Horizontal synchronous signal	
43	IVS	I	Vertical synchronous signal	
44	CLK	I	Data clock	
45	AV _{DD}	P	Analog power supply(+5V)	
46	AV _{DD}	P	Analog power supply(+5V)	
47	V _{CC}	P	Digital power supply(+3.3V)	
48	V _{CC}	P	Digital power supply(+3.3V)	
49	NC	-	No connect	

50	V _{GL}	I	Negative power for scan driver	
51	V _{GL}	I	Negative power for scan driver	
52	NC	-	No connect	
53	V _{GH}	I	Positive power for scan driver	
54	NC	-	No connect	
55	NC	-	No connect	
56	V _{COM}	I	V _{COM} input	
57	V _{COM}	I	V _{COM} input	
58	DEN	I	Data enabling signal	
59	GND	P	Ground	
60	GND	P	Ground	

Note: P - Power
 I- Input
 O-Output

Note 2 :

Mode	D[23:16]	D[15:8]	D[7:0]	IHS	IVS	DEN
ITU-R BT 656	D[23:16]	GND	GND	NC	NC	NC
ITU-R BT 601	D[23:16]	GND	GND	IHS	IVS	NC
8 bit RGB	D[23:16]	GND	GND	IHS	IVS	NC for HV Mode
						DEN for DEN Mode
24 bit RGB	R[7:0]	G[7:0]	B[7:0]	IHS	IVS	NC for HV Mode
						DEN for DEN Mode

3. Operation Specifications

3.1. Absolute Ratings of Environment

Item	Symbol	Values		Unit	Remark
		Min.	Max.		
Operation temperature	T _{OP}	-10	60	°C	Note 1, 2
Storage temperature	T _{ST}	-20	70	°C	Note 1, 2

Note 1: 90% RH Max. (Max wet temp. is 40°C)

Maximum wet-bulb temperature is at 38°C or less. And No condensation (no drops of dew)

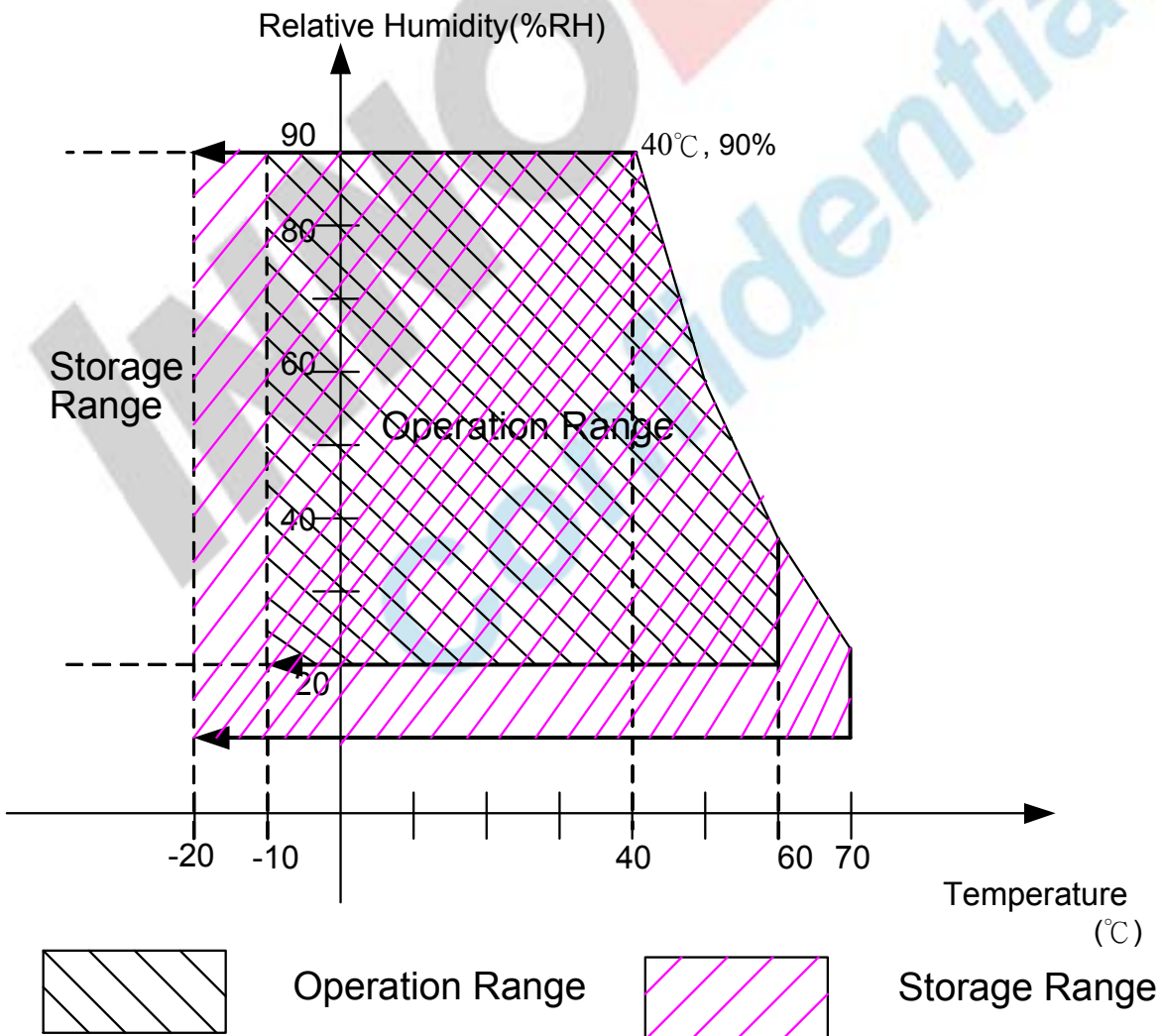

Note 2: In case of below 0 the response time of liquid crystal (LC) becomes slower and the color of panel darker than normal one. Level of retardation depends on temperature, because of LC's characteristics.

The copyright belongs to InnoLux. Any unauthorized use is prohibited.

3.2. Electrical Absolute Maximum Ratings

(GND =0V, Note 1)

Item	Symbol	Values		Unit	Remark
		Min.	Max.		
Power voltage	V _{CC}	-0.3	7	V	
	A _V DD	-0.3	7	V	
	V _{GH}	-0.3	18	V	
	V _{GL}	-15	0.3	V	
	V _{GH} -V _{GL}	-	33	V	
LED Reverse Voltage	V _r	-	1.2	V	Each LED
LED Forward Current	I _f	-	25	mA	Each LED

Note 1: Device is subject to be damaged permanently if stresses beyond those absolute maximum ratings listed above.

Note 2: V_r conditions: Zener Diode 20mA.

3.3. Power Sequence

3.3.1. Power on:

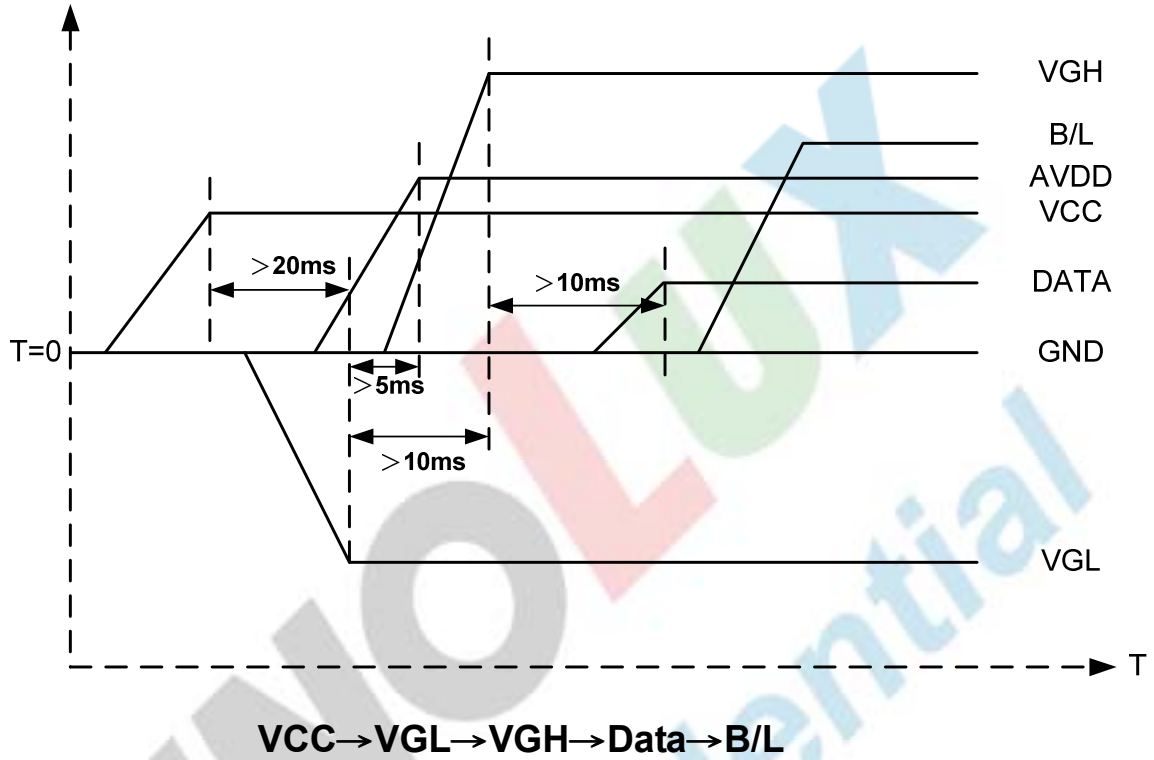

3.3.2. Power off:

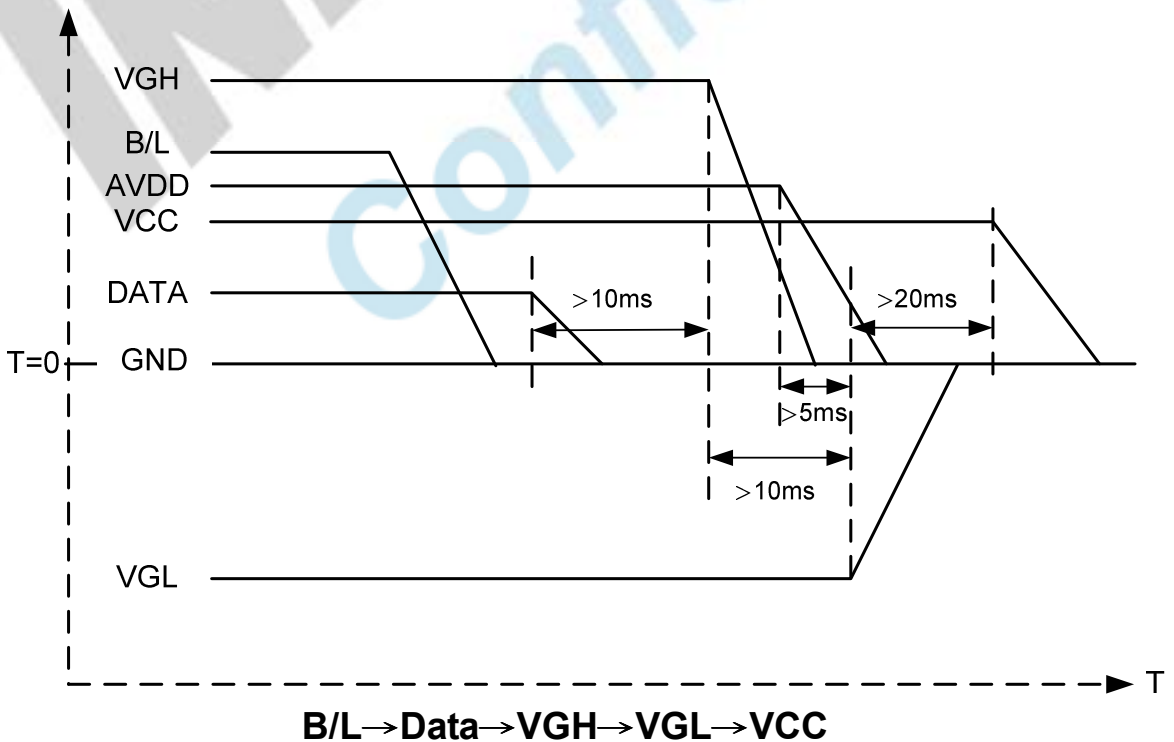

Note: Data include D₀ ~ D₂₃, SPENA, SPCK, SPDA, IHS, IVS, CLK, DEN.

The copyright belongs to InnoLux. Any unauthorized use is prohibited.

3.4. Electrical Characteristics

3.4.1. Typical Operation Conditions

(GND =0V, Note 2)

Item	Symbol	Values			Unit	Remark
		Min.	Typ.	Max.		
Power voltage	V_{CC}	3.0	3.3	3.6	V	
	AV_{DD}	4.8	5.0	5.2	V	
	V_{GH}	14.3	15.0	15.7	V	
	V_{GL}	-10.5	-10.0	-9.5	V	
V_{COM}	V_{CAC}	-	5.0	-	V	Note 1
	V_{CDC}	1.29	1.49	1.69	V	
Input logic high voltage	V_{IH}	$0.7V_{CC}$	-	V_{CC}	V	
Input logic low voltage	V_{IL}	0	-	$0.3V_{CC}$	V	

Note 1: The brightness of LCD panel could be changed by adjusting the AC component of V_{COM} .

Note 2: Be sure to apply GND, V_{CC} , and V_{GL} , to the LCD first, and then apply V_{GH} .

3.4.2. Current Consumption

(GND =0V)

Item	Symbol	Values			Unit	Remark
		Min.	Typ.	Max.		
Current for Driver	I_{GH}	-	100	300	uA	$V_{GH} = +15V$
	I_{GL}	-	-100	-300	uA	$V_{GL} = -10V$
	I_{CC}	-	1.3/11*	15	mA	$V_{CC} = 3.3V$
	I_{DD}	-	2/4*	10	mA	$AV_{DD} = 5V$

* Note: 8 bit/24 bit RGB input : I_{CC} Typical=1.3 mA
 I_{DD} Typical=2 mA
 ITU-R BT 656/601 input : I_{CC} Typical=11 mA
 I_{DD} Typical=4 mA

3.4.3. Backlight Driving Condition

Item	Symbol	Values			Unit	Remark
		Min.	Typ.	Max.		
LED forward voltage	V_L	18.6	19.8	21	V	Note 1
LED forward current	I_L	18	20	22	mA	Note 1
LED life time	-	20,000	-	-	Hr	Note 2

Note 1: The LED driving condition is defined for each LED module. (See the figure)

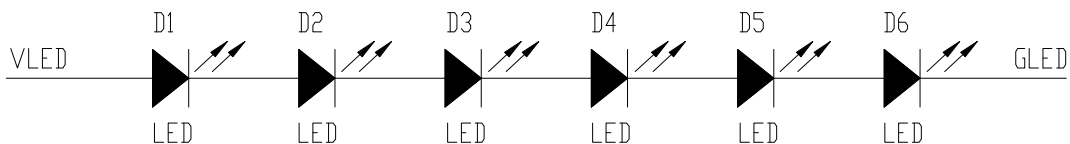

Note 2: The “LED life time” is defined as the module brightness decrease to 50% original brightness that the ambient temperature is 25°C and $I_L = 20mA$. The LED lifetime could be decreased if operating I_L is larger than 20 mA.

3.5. Timing Characteristics

3.5.1. AC Electrical Characteristics

3.3.1.1 AC Electrical Characteristics(VCC=3.3V,AVDD=5.0V, GND=AGND=0V,TA=25°C)

Item	Symbol	Values			Unit.	Remark
		Min.	Typ.	Max.		
System Operation Timing						
VDD power on slew time	T _{POR}			1000	us	From 0V to 90% VDD
Input / Output Timing						
CLKIN clock time	T _{clk}	37	98		ns	
HSD to CLKIN	T _{hc}	-	-	1	T _{clk}	
HSD width	T _{hwh}	1	-	-	T _{clk}	
VSD width	T _{vwh}	1	-	-	Th	
HSD period time	Th	33.3	35.7	67	us	
VSD setup time	T _{vst}	12	-	-	ns	
VSD hold time	T _{vhd}	12	-	-	ns	
HSD setup time	T _{hst}	12	-	-	ns	
Data set-up time	T _{dsu}	12	-	-	ns	Data to CLKIN
Data hold time	T _{dhd}	12	-	-	ns	Data to CLKIN
DEN setup time	T _{esd}	12	-	-	ns	DEN to CLKIN

3.3.1.2 Timing Table

ITU-R BT 601 Mode A/B*(Note 1)

ITEM	Symbol	Value			Unit	Remark
		Min.	Typ.	Max.		
CLKIN frequency	Fclk	-	24.54	28	Mhz	VCC=3.3V
CLKIN cycle time	Tclk	35.7	40/37	-	ns	
CLKIN pulse duty	Tcwh	40	50	60	%	Tclk

ITU-R BT 656 Mode A/B*(Note 1)

ITEM	Symbol	Value			Unit	Remark
		Min.	Typ.	Max.		
CLKIN frequency	Fclk	-	27	28	Mhz	VCC=3.3V
CLKIN cycle time	Tclk	35.7	37	-	ns	
CLKIN pulse duty	Tcwh	40	50	60	%	Tclk

8 bit RGB 960x240 Mode

ITEM	Symbol	Value			Unit	Remark
		Min.	Typ.	Max.		
CLKIN frequency	Fclk	-	13.5	28	Mhz	VCC=3.3V
CLKIN cycle time	Tclk	35.7	74	-	ns	
CLKIN pulse duty	Tcwh	40	50	60	%	Tclk

Note 1: YUV mode A: Data sequence are "Cb-Y-Cr-Y..."
 YUV mode B: Data sequence are "Cr-Y-Cb-Y..."

24 Bit RGB 960 CH Mode (320(RGB) x 240)

Item	Symbol	Values			Unit.	Remark
		Min.	Typ.	Max.		
CLKIN frequency	F _{clk}	-	10.2	28	Mhz	VDD=3.0~3.6V
CLKIN cycle time	T _{clk}	37	98		ns	
CLKIN pulse duty	T _{cwh}	40	50	60	%	T _{clk}

3.3.1.3 3-wire serial communication AC timing

Item	Symbol	Values			Unit	Remark
		Min.	Typ.	Max.		
Serial clock Period Time	Tspck	320	-	-	ns	
SPCK pulse duty cycle	Tscdut	40	50	60	%	
Serial data setup time	Tisu	120	-	-	ns	
Serial data hold time	Tihd	120	-	-	ns	
SPENA select distinguish	Tcd	1	-	-	us	
SPENA to VSD	Tcv	1	-	-	us	
SPENA to SPDA	Teck	0	-	640	ns	
SPDA to SPENA	Tcke	0	-	640	ns	
SPCK pulse high width	Tckh	120	-	-	ns	
SPCK pulse low width	Tckl	120	-	-	ns	

3.5.2. Timing Diagram

Input Data Timing

1. Clock and Data Input Timing Diagram

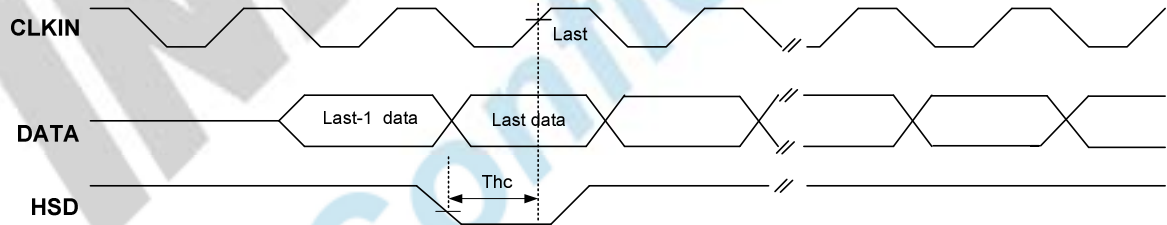
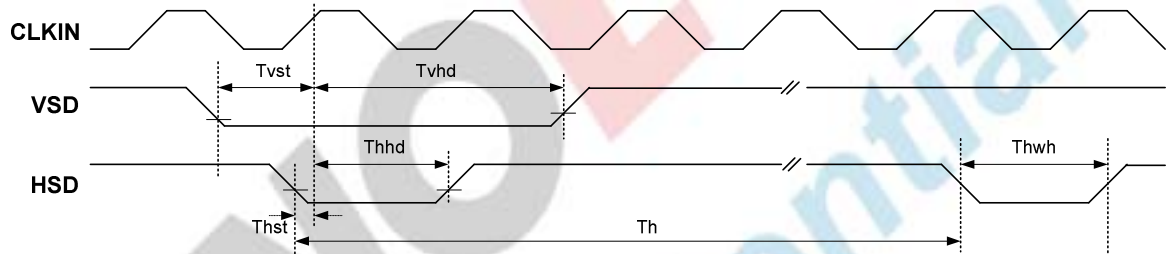
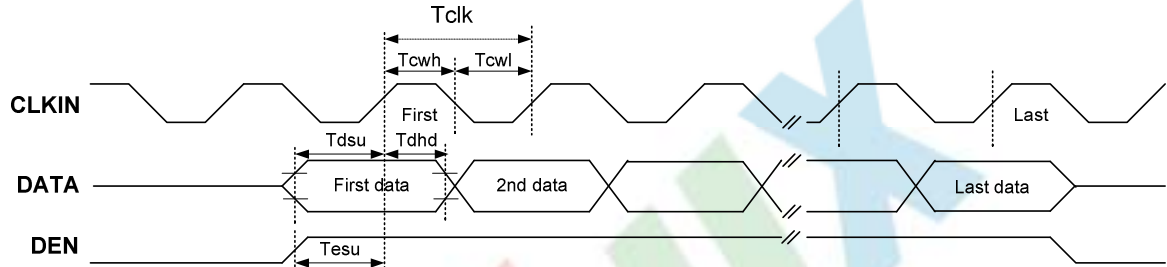

2. 8 bit RGB input Data format

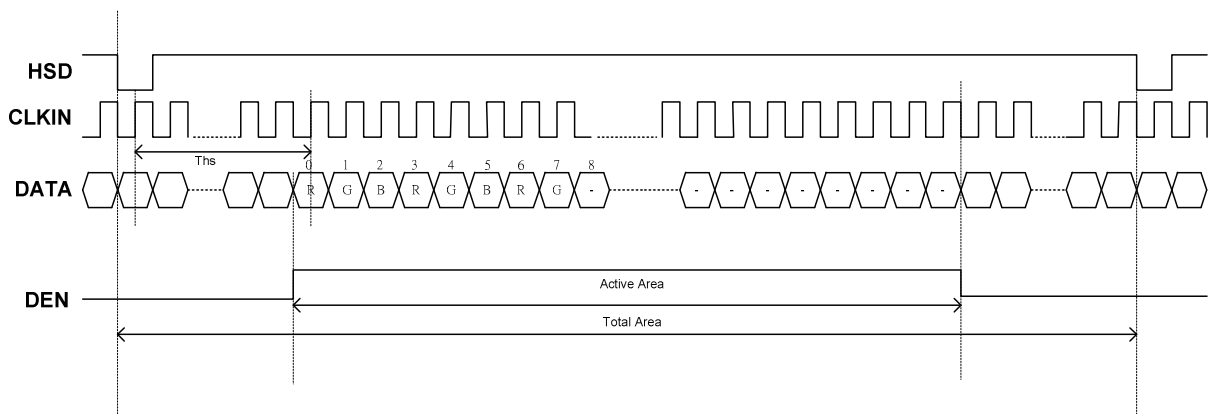

版權屬於群創所有，禁止任何未經授權的使用

The copyright belongs to InnoLux. Any unauthorized use is prohibited.

3. ITU-R BT 601

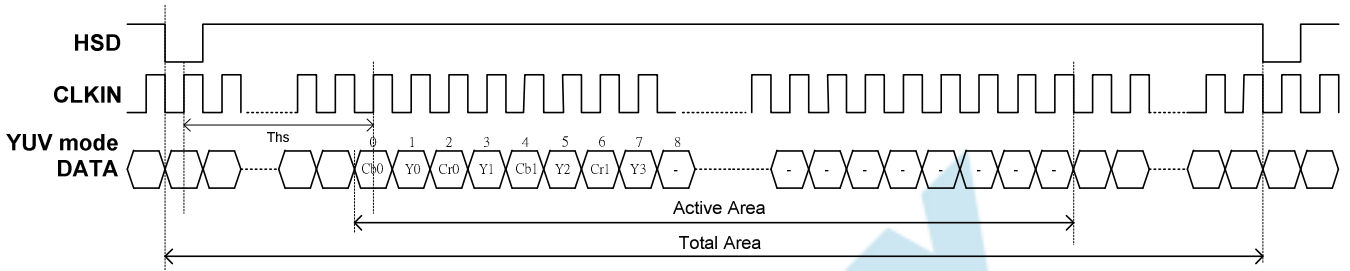

4. ITU-R BT 656

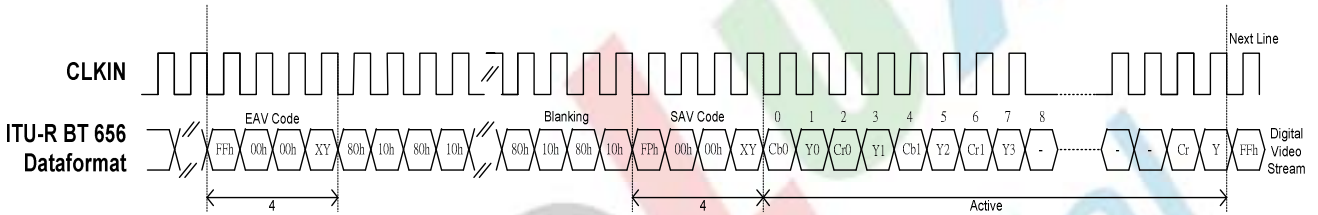

5. 24 bit RGB mode for 960 x 240

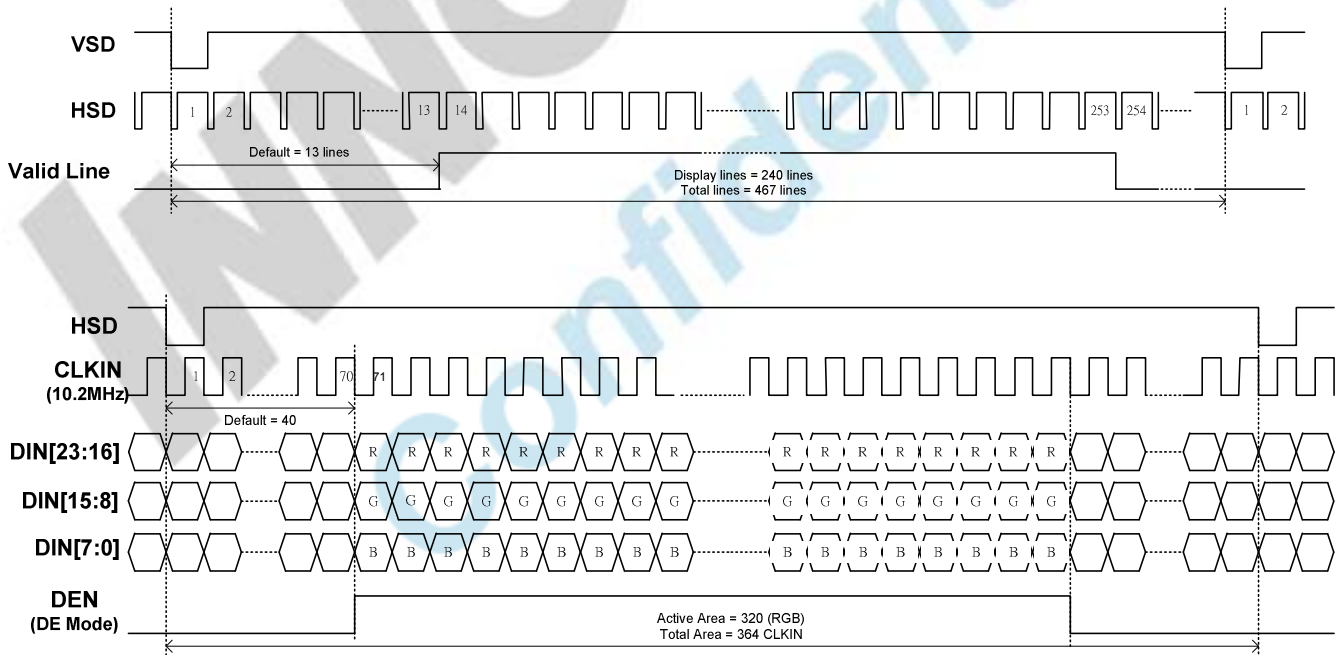

3-Wire Timing Diagram

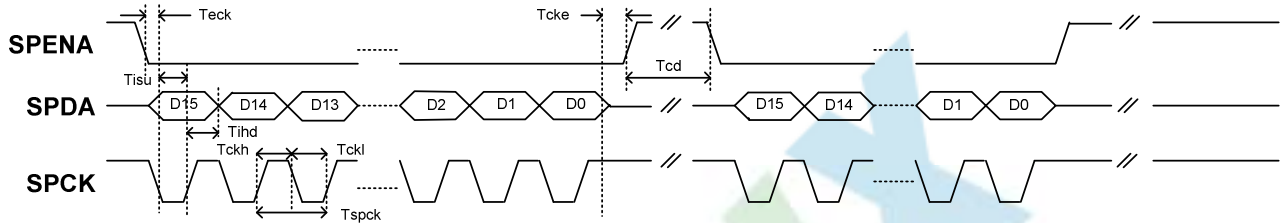

Note: 3-Wire Control Registers List

3-Wire Register		Register Description		
D[15:10]	Name	Init	R/W	Function Description
000000b	R00	03h	R/W	System control register
000001b	R01	40h	R/W	Timing controller function register
000010b	R02	11h	R/W	Operation control register
000011b	R03	(cch)*	R/W	Input data format control register
000100b	R04	93h	R/W	Source Timing delay control register
000101b	R05	12h	R/W	Gate Timing delay control register
000111b	R07	03h	R/W	Internal function control register
001000b	R08	08h	R/W	RGB contrast control register
001001b	R09	40h	R/W	RGB brightness control register
001010b	R0A	88h	R/W	Hue/Saturation control register
001011b	R0B	88h	R/W	R/B Sub-contrast control register
001100b	R0C	20h	R/W	R Sub-brightness control register
001101b	R0D	20h	R/W	B Sub-brightness control register

* Note: c4h:ITU-R BT 656 Mode
 c2h:ITU-R BT 601 Mode
 c8h:8 bit RGB Mode(HV Mode)
 c9h:8 bit RGB Mode(DE Mode)
 cch:24 bit RGB Mode (HV mode)
 cdh:24 bit RGB Mode (DE mode)

版權屬於群創所有，禁止任何未經授權的使用

The copyright belongs to InnoLux. Any unauthorized use is prohibited.

4. Touch Screen Panel Specifications

4.1. Electrical Characteristics

Item	Value			Unit	Remark
	Min.	Typ.	Max.		
Linearity	-1.5	-	1.5	%	Analog X and Y directions
Terminal Resistance	160	-	840	Ω	X(Film side)
	160	-	640	Ω	Y(Glass side)
Insulation resistance	25	-	-	MΩ	DC 25V
Voltage	-	5	7	V	DC
Chattering	-	-	10	ms	100kΩ pull-up
Transparency	80	-	-	%	JIS K7105

Note: Do not operate it with a thing except a polyacetal pen (tip R0.8mm or less) or a finger, especially those with hard or sharp tips such as a ball point pen or a mechanical pencil.

4.2. Mechanical & Reliability Characteristics

Item	Value			Unit	Remark
	Min.	Typ.	Max.		
Activation force	80	-	-	g	Note 1
Durability-surface scratching	Write 100,000	-	-	characters	Note 2
Durability-surface pitting	1,000,000	-	-	touches	Note 3
Surface hardness	3	-	-	H	JIS K5400

Note 1: Activation force test condition

- (1) Input DC 5V on X direction, Drop off Polyacetal Stylus (R0.8), until output voltage stabilize ,then get the activation force °
- (2) R8.0mm Silicon rubber for finger Activation force test
- (3) Test point: 9 points

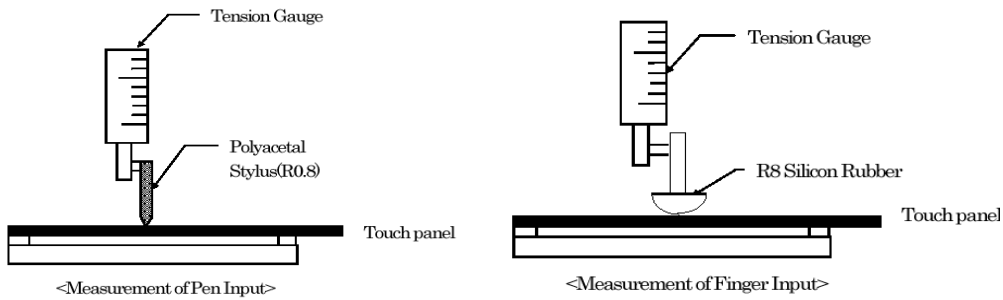

Note 2: Measurement for surface area.

- Scratch 100,000 times straight line on the film with a stylus change every 20,000 times.
- Force: 250gf.
- Speed: 60mm/sec.
- Stylus: R0.8 polyacetal tip.

Note 3: Pit 1,000,000 times on the film with a R0.8 silicon rubber.

- Force: 250gf.
- Speed: 2times/sec.

4.3. Touch Screen Panel Block

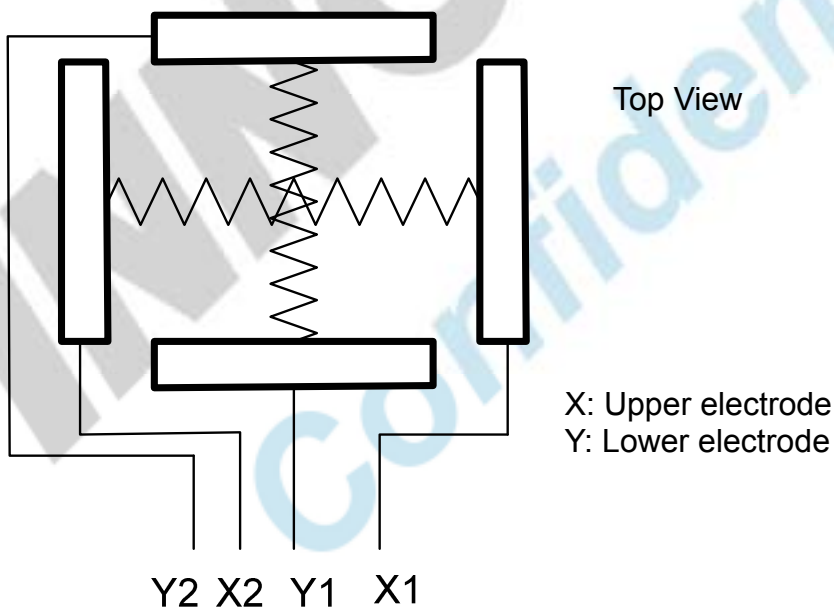

4.4. Touch Screen Panel Pin Definition

Pin No.	Symbol	I/O	Function	Remark
1	X1	Right	Right electrode – differential analog	
2	Y1	Bottom	Bottom electrode – differential analog	
3	X2	Left	Left electrode – differential analog	
4	Y2	Top	Top electrode – differential analog	

INNOLUX
 Confidential

5. Optical Specifications

Item	Symbol	Condition	Values			Unit	Remark
			Min.	Typ.	Max.		
Viewing angle (CR≥10)	θ_L	$\Phi=180^\circ$ (9 o'clock)	55	65	-	degree	Note 1 (Without Touch Screen)
	θ_R	$\Phi=0^\circ$ (3 o'clock)	55	65	-		
	θ_T	$\Phi=90^\circ$ (12 o'clock)	35	45	-		
	θ_B	$\Phi=270^\circ$ (6 o'clock)	55	65	-		
Response time	T_{ON}	Normal $\theta=\Phi=0^\circ$	-	15	30	msec	Note 3
	T_{OFF}		-	20	50	msec	Note 3
Contrast ratio	CR		200	300	-	-	Note 4
Color chromaticity	W_X	Normal $\theta=\Phi=0^\circ$	0.26	0.31	0.36	-	Note 2 Note 5
	W_Y		0.28	0.33	0.38	-	Note 6 (Without Touch Screen)
Luminance	L_1		230	280	-	cd/m ²	Note 6 (With Touch Screen)
	L_2		300	350	-	cd/m ²	Note 6 (Without Touch Screen)
Luminance Uniformity	Y_U		70	75	-	-	Note 7

Test Conditions:

1. $V_{CC}=3.3V$, $AV_{DD}=5.0V$, $I_L=20mA$ (Backlight current), the ambient temperature is 25°C.
2. The test systems refer to Note 2.

Note 1: Definition of viewing angle range

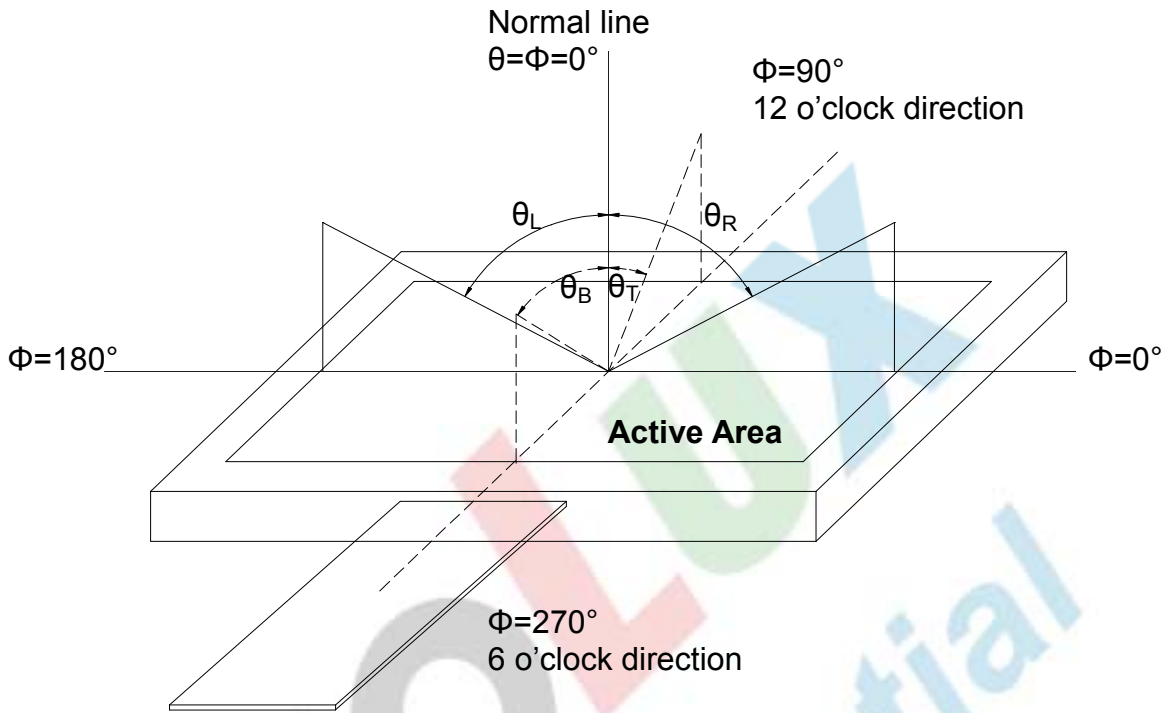

Fig. 5-1 Definition of viewing angle

Note 2: Definition of optical measurement system.

The optical characteristics should be measured in dark room. The optical properties are measured at the center point of the LCD screen. (Response time is measured by Photo detector TOPCON BM-7, other items are measured by BM-5A/Field of view: 1° /Height: 500mm.)

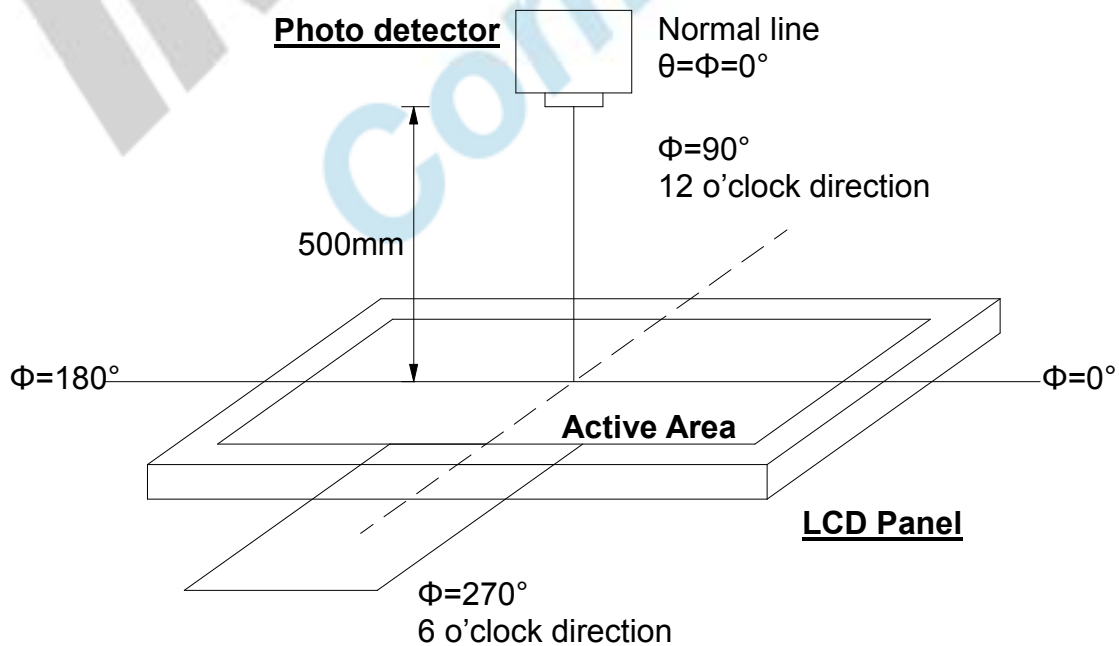

Fig. 5-2 Optical measurement system setup

Note 3: Definition of Response time

The response time is defined as the LCD optical switching time interval between "White" state and "Black" state. Rise time (T_{ON}) is the time between photo detector output intensity changed from 90% to 10%. And fall time (T_{OFF}) is the time between photo detector output intensity changed from 10% to 90%.

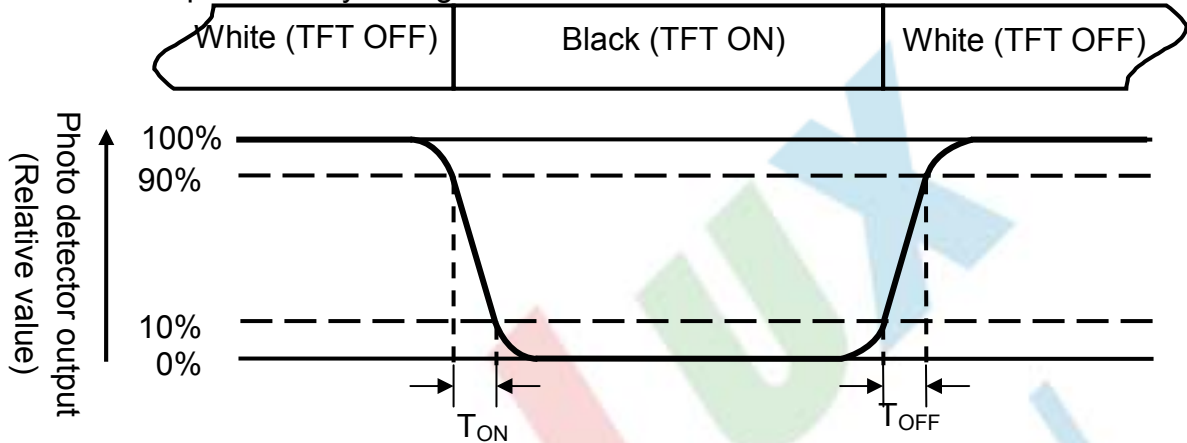

Fig. 5-3 Definition of response time

Note 4: Definition of contrast ratio

$$\text{Contrast ratio (CR)} = \frac{\text{Luminance measured when LCD is on the "White" state}}{\text{Luminance measured when LCD is on the "Black" state}}$$

Note 5: Definition of color chromaticity (CIE1931)

Color coordinates measured at center point of LCD.

Note 6: All input terminals LCD panel must be ground when measuring the center area of the panel. The LED driving condition is $I_L=20\text{mA}$ of which each LED module is 3 LED serial.

Note 7: Definition of Luminance Uniformity

To test for uniformity, the tested area, which is inside the active area, is divided into 3 rows and 3 columns. The measurement spot is placed at the center of each box.

$$\text{Luminance Uniformity (Yu)} = \frac{B_{min}}{B_{max}}$$

L-----Active area length W----- Active area width

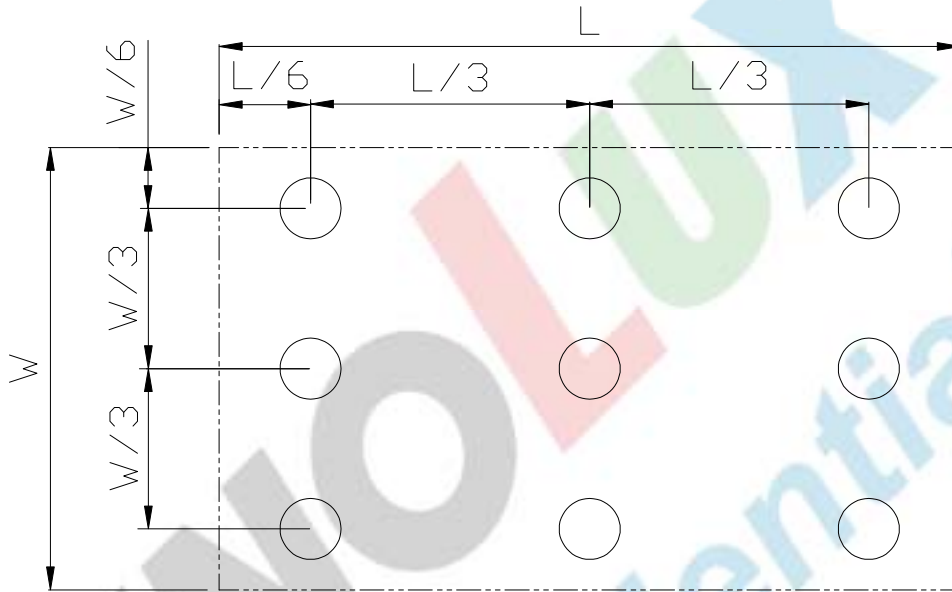

Fig. 5-4 Definition of uniformity

B_{max}: The measured maximum luminance of all measurement position.

B_{min}: The measured minimum luminance of all measurement position.

7. Handling Precautions

7.1. Safety

Liquid crystal is poisonous. Do not put it in your mouth. If liquid crystal touches your skin or clothes, wash it off immediately by using soap and water.

7.2. Handling

1. The LCD panel is plate glass. Do not subject the panel to mechanical shock or to excessive force on its surface.
2. The polarizer attached to the display is easily damaged. Please handle it carefully to avoid scratch or other damages.
3. To avoid contamination on the display surface, do not touch the module surface with bare hands.
4. Keep a space so that the LCD panels do not touch other components.
5. Put cover board such as acrylic board on the surface of LCD panel to protect panel from damages.
6. Transparent electrodes may be disconnected if you use the LCD panel under environmental conditions where the condensation of dew occurs.
7. Do not leave module in direct sunlight to avoid malfunction of the ICs.

7.3. Static Electricity

1. Be sure to ground module before turning on power or operating module.
2. Do not apply voltage which exceeds the absolute maximum rating value.

7.4. Storage

1. Store the module in a dark room where must keep at $+25\pm 10^{\circ}\text{C}$ and 65%RH or less.
2. Do not store the module in surroundings containing organic solvent or corrosive gas.
3. Store the module in an anti-electrostatic container or bag.

7.5. Cleaning

1. Do not wipe the polarizer with dry cloth. It might cause scratch.
2. Only use a soft sloth with IPA to wipe the polarizer, other chemicals might permanent damage to the polarizer.

9. Package Drawing

9.1. Packaging Material Table

No	Item	Model (Material)	Dimensions(mm)	Unit Weight(Kg)	Quantity (pcs)	Remark
1	LCM module	PT035TN01 V.6	78.2 ×65.0 × 4.6	0.0446	260	
2	Corrugated Board-1	BC Corrugated Paper	510×343	0.130	2	
3	Corrugated Board-2	B Corrugated Paper	1152×512	0.260	1	
4	Corrugated Bar	B Corrugated Paper	343×104	0.020	12	
5	Partition	BC Corrugated Paper	512×343×106	1.045	2	
6	Dust-Proof Bag	PE	700×530	0.0604	1	
7	A/S Bag	PE	112×90	1.1108×10 ⁻³	260	
8	Carton	Corrugated Paper	530×355×255	1.100	1	
9	Total weight	15.895±5%Kg				

9.2. Packaging Quantity

(1) LCM quantity per Partition:	2 row x 21 pcs + 4 row x 22 pcs = 130 pcs
(2) Total LCM quantity in Carton:	2 layer x 130 pcs per Partition = 260 pcs

9.3. Packaging Drawing

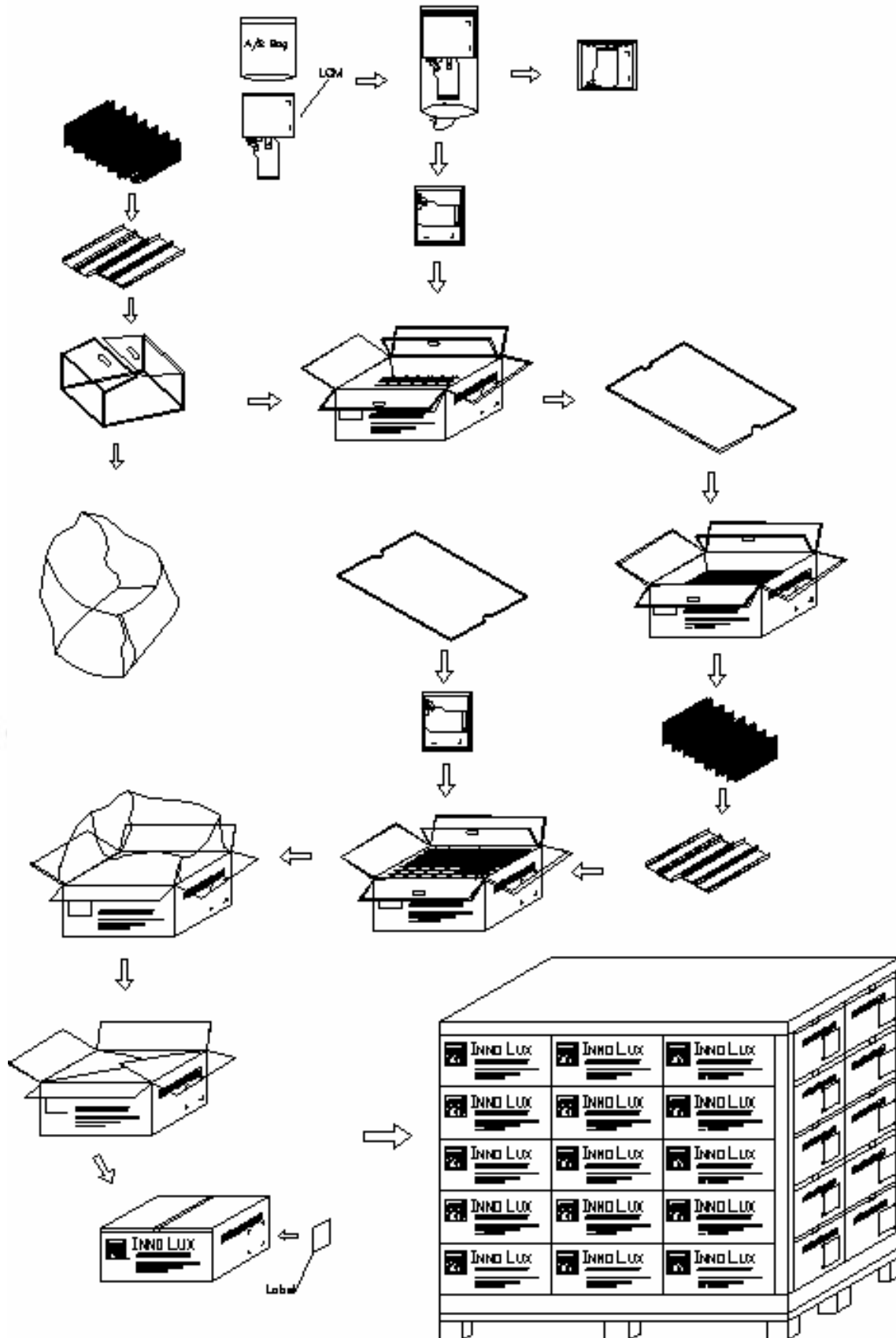

版權屬於群創所有，禁止任何未經授權的使用

The copyright belongs to InnoLux. Any unauthorized use is prohibited.