

DIODE

150A Avg 800 Volts

PT150KN8

回路図 CIRCUIT

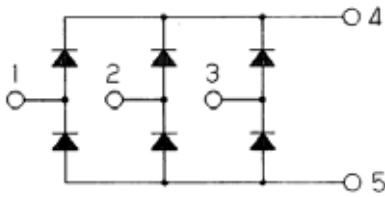

外形寸法図 OUTLINE DRAWING

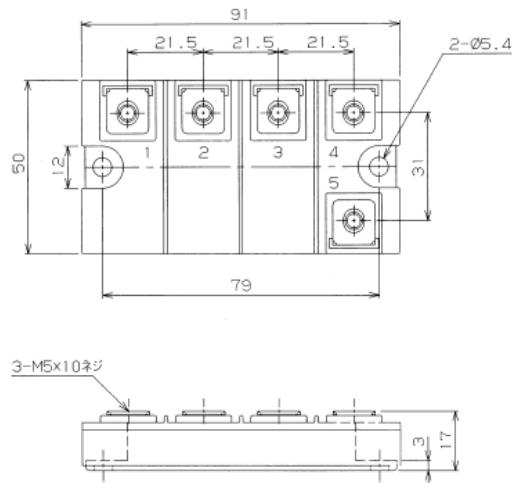

Dimension: [mm]

最大定格 Maximum Ratings

項目 Parameter	記号 Symbol	耐圧クラス Grade		単位 Unit
		PT150KN8		
くり返しピーク逆電圧 Repetitive Peak Reverse Voltage	*1 V_{RRM}	800		V
非くり返しピーク逆電圧 Non Repetitive Peak Reverse Voltage	*1 V_{RSM}	900		V

項目 Parameter	記号 Symbol	条件 Conditions	定格値 Max. Rated Value	単位 Unit		
平均出力電流 Average Rectified Output Current	$I_{O(AV)}$	三相全波整流 $T_c=T_t=105$ 3-Phase Full Wave Rectified (T_c : 測定点チップ直下 / T_t : Terminal)	150	A		
サージ順電流 Surge Forward Current	*1 I_{FSM}	50Hz 正弦半波, 1 サイクル, 非くり返し Half Sine Wave, 1 Pulse, Non-Repetitive	1200	A		
電流二乗時間積 I Squared t	*1 I^2t	2 ~ 10ms	7200	A ² s		
動作接合温度範囲 Operating Junction Temperature Range	T_{jw}		-40 ~ +150			
保存温度範囲 Storage Temperature Range	T_{stg}		-40 ~ +125			
絶縁耐圧 Isolation Voltage	Viso	端子 - ベース間, AC 1 分間 Terminal to Base, AC 1min.	2500	V		
締付トルク Mounting Torque	ベース部 Mounting	F	サーマルパワド 塗布 Greased	M5	2.4 ~ 2.8	N・m
	主端子部 Terminal			M5	2.4 ~ 2.8	N・m

電気的特性 Electrical Characteristics

項目 Parameter	記号 Symbol	条件 Conditions	特性値 (最大) Maximum Value	単位 Unit
ピーク逆電流 Peak Reverse Current	*1 I_{RM}	$T_j=150$, $V_{RM}=V_{RRM}$	5	mA
ピーク順電圧 Peak Forward Voltage	*1 V_{FM}	$T_j=25$, $I_{FM}=150A$	1.35	V
熱抵抗 Thermal Resistance	$R_{th(j-c)}$	接合部 - ケース間 (トコ: T_c 測定点チップ直下) Junction to Case, Total	0.07	W
接線熱抵抗 Thermal Resistance	$R_{th(c-f)}$	ケース - フィン間 (トコ), サーマルパワド 塗布 Case to Fin, Total, Greased	0.06	W

質量 - - - 約 210g
Approximate Weight

*1: 1アーム当りの値 Value Per 1 Arm.

定格・特性曲線

順電圧特性
FORWARD CURRENT VS. VOLTAGE

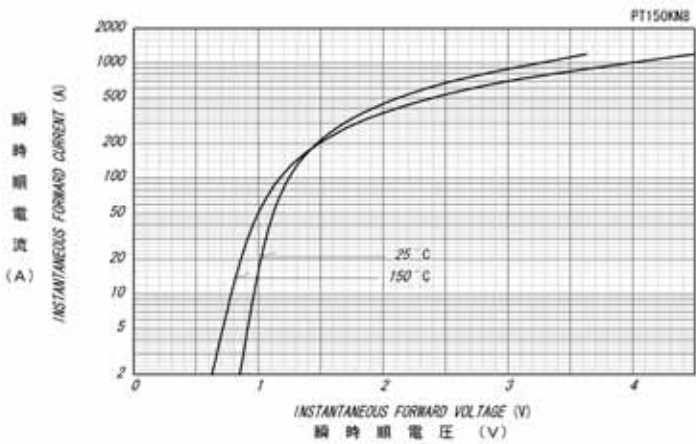

平均順電力損失特性
AVERAGE FORWARD POWER DISSIPATION

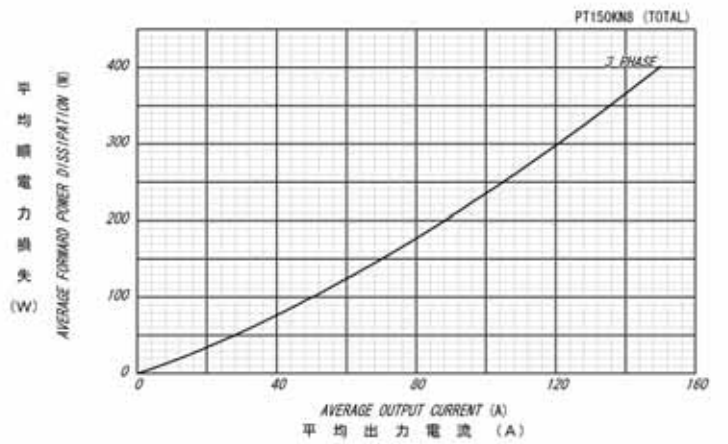

平均出力電流 - ケース温度定格
AVERAGE OUTPUT CURRENT VS. CASE TEMPERATURE

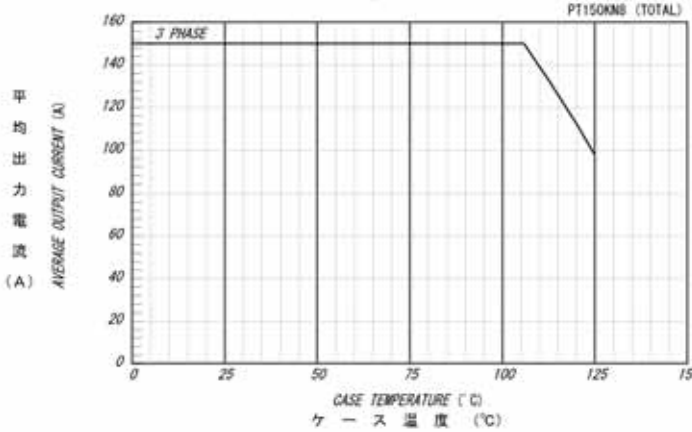

サージ順電流定格
SURGE CURRENT RATINGS

