

PT SERIES

Compact Pushbutton Stations • Economical Sealed Control Units

A-75-17

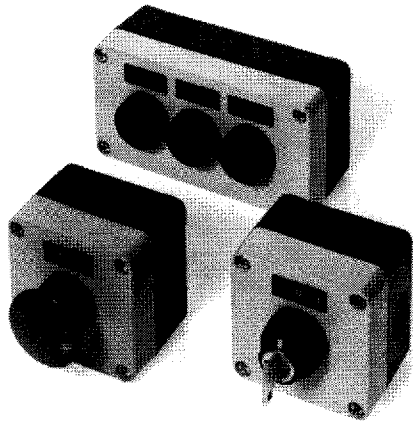

PT Series control stations combine the style and stamina of **RELIANT'22** pushbuttons and selectors with gasket-sealed enclosures (IP65). Design engineers can choose standard models or configure custom stations to meet the requirements of specific applications. Empty enclosures may be used with any **RELIANT'22** operators of pilot lights.

ELECTRICAL RATINGS

PT Series control stations use proven V40/V50 UL/CSA contact blocks, based mounted for easy wiring.

CONDITION	FUNCTION	120 VAC	300 VAC	600 VAC
Inductive Load AC (0.35 P.F.)	Make	30A	12A	6A
	Carry	6A	6A	6A
	Break	3A	1.2A	0.6A
Resistive (0.75 P.F.)	All	6A	6A	6A
DC Inductive & Resistive	Make/Break	1.1A	1.1A	1.1A
	Carry	6A	6A	6A

MODEL	DESCRIPTION	SIZE CODE	*COVER COLOR	BUTTON COLORS	LEGEND PLATES
PT81V	SINGLE FLUSHBUTTON, 1 N.O. CONTACT	A	GRAY	GREEN	START
PT81R	SINGLE FLUSH BUTTON, 1 N.C. CONTACT	A	GRAY	RED	STOP
PT85R	SINGLE WOBBLE MUSHROOM BUTTON, 1 N.C. CONTACT	A	YELLOW	RED	STOP
PT65R	SINGLE PUSH-LOCK/TWIST RELEASE MUSHROOM BUTTON, 1 N.C. CONTACT	A	YELLOW	RED	STOP
PT200N	SINGLE KEYLOCK OPERATOR, 1 N.O. CONTACT	A	GRAY	BLACK	0 & 1
PT82	TWO-BUTTON CONTROL STATION, 1 N.O. (GREEN) AND 1 N.C. (RED) CONTACT	B	GRAY	GREEN, RED	START, STOP
PT83	THREE-BUTTON CONTROL STATION, 2 N.O. (GREEN) AND 1 N.C. (RED) CONTACTS	C	GRAY	2 GREEN, 1 RED	FORWARD, STOP, REVERSE
PT87	TWO-BUTTON CONTROL STATION WITH RED PILOT LIGHT (LESS LAMP, 1 N.O. (GREEN) AND 1 N.C. (RED) CONTACT	C	GRAY	GREEN & RED	START, STOP

*BASE (BOTTOM OF HOUSING) IS BLACK FOR ALL MODELS.

ENCLOSURES WITHOUT OPERATORS

All enclosures are gasket-sealed to provide ISO PI65 degree of protection, meeting NEMA Type 12 and 13. Each enclosure has one knockout on each side (Pg13.5) and one .75" (19mm) knock on bottom. Mounting hole dimensions are indicated on the base of each unit.

MODEL	DESCRIPTION	HOLE DIAMETER	SIZE CODE
PT221G	SINGLE-HOLE BOX WITH YELLOW COVER	22mm, .88"	A
PT221H	SINGLE-HOLE BOX WITH GRAY COVER	22mm, .88"	A
PT222	TWO-HOLE BOX WITH GRAY COVER	22mm, .88"	B
PT223	THREE-HOLE BOX WITH GRAY COVER	22mm, .88"	C
PT301H	SINGLE-HOLE BOX WITH GRAY COVER	30mm, 1.18"	A

SINGLE OPERATOR CONTROL

Available with flush pushbuttons, wobble mushroom, twist/lock mushroom or keylock as standard, or any **RELIANT'22** operator on special order. Use maximum of two contacts. Refer to pages H1-H4.

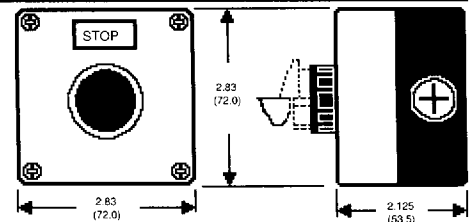

TWO OPERATOR CONTROL

Standard two-operator controls have flush pushbuttons. Economical custom stations can include such variations as pushbutton with pilot light, pushbutton with keylock, one flush button with one extended button, two pilot lights, etc. Refer to pages H1-H4.

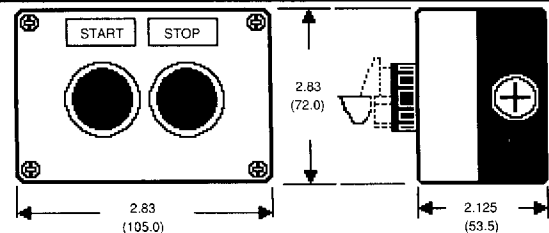

THREE OPERATOR CONTROL

Standard three-operator stations have flush pushbuttons. Custom controls units may include various **RELIANT'22** combinations. Please send application requirement for proposal, or call for fast response.

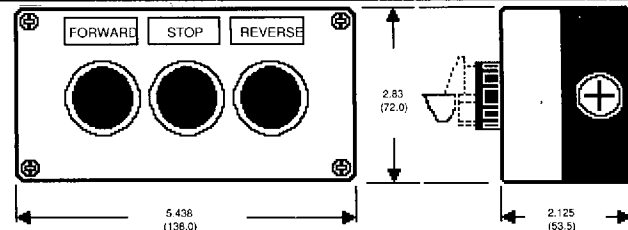

SPECIFICATIONS SUBJECT TO CHANGE WITHOUT NOTICE.



Alcoswitch®

1551 Osgood Street

N. Andover, MA 01845 USA

Tel: (508)685-4371

FAX: (508)686-9545

TLX: 275423

H18

RELIANT'22 SERIES

Features

- Fits 7/8"(22mm) diameter holes
- Full size buttons
- Meets NEMA 1, 12 and 13
- Rugged heavy-duty metal bushing, or thermoplastic bushings for full installation
- Matte black beveled frame finish
- IP65 protection level
- Snap-block contacts
- 6A @ 600VAC
- Easy "no tool" mounting
- Choice of screw terminals or dual .110/.250 quick connects
- Double-break silver contacts standard, gold plated optional
- Stackable

Installation & Assembly

QM/RM MODELS

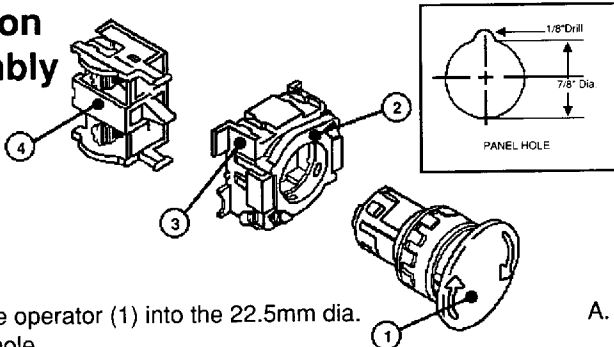

- Engage the operator (1) into the 22.5mm dia. mounting hole.
- Engage metal ring (2) with operator (bayonet lock). Tighten set screws against back of panel.
- Snap the contact blocks (4) on the support(3).
- Snap the support (3) complete with contact blocks (4) on the metal ring (2).

See page H6 for guidance in selecting contact blocks.

QT/RT MODELS

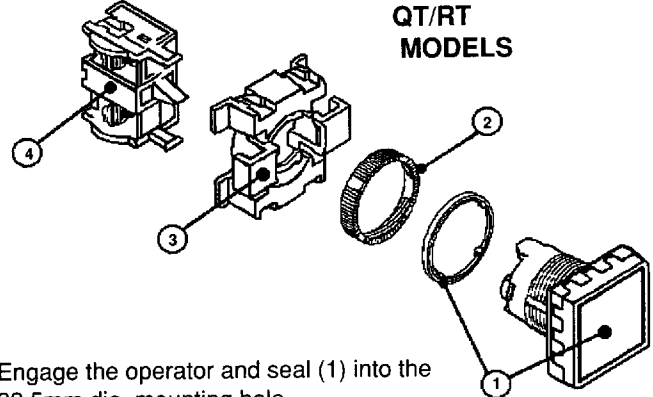

- Engage the operator and seal (1) into the 22.5mm dia. mounting hole.
- Mount back-up nut (2) on bushing and then tighten against panel.
- Snap the contact blocks (4) on the support (3).
- Snap the support (3) complete with contact blocks (4) onto operator (1).

See page H6 for guidance in selecting contact blocks.

RELIANT' 22 7/8" Oil-Tight • Round

MOMENTARY, Metal Bushings

Contact blocks not supplied, order separately.
(See page H6.)

MODEL	TYPE
RM010(*)	FLUSH BUTTON
RM020(*)	EXTENDED BUTTON
RM015(*)	EXTENDED GUARD

(*) SPECIFY COLOR BY ADDING SUFFIX NUMBER: (0)BLACK, (2)RED, (4)YELLOW, (5)GREEN, (6)BLUE, (8)GREY, (9)WHITE.
NOTE: FRONT BEVELED FRAME IS BLACK.

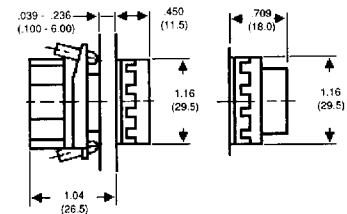
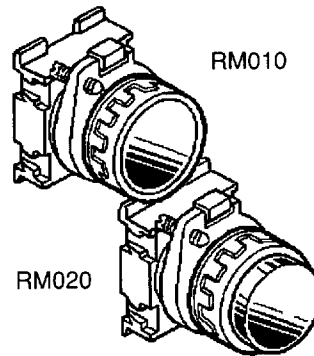

MOMENTARY, Thermoplastic Bushings (Threaded)

Contact blocks not supplied, order separately.
(See page H6.)

MODEL	TYPE
RT010(*)	FLUSH BUTTON
RT020(*)	EXTENDED BUTTON

(*) SPECIFY COLOR BY ADDING SUFFIX NUMBER: (0)BLACK, (2)RED, (4)YELLOW, (5)GREEN, (6)BLUE, (8)GREY, (9)WHITE.
NOTE: FRONT BEVELED FRAME IS BLACK.

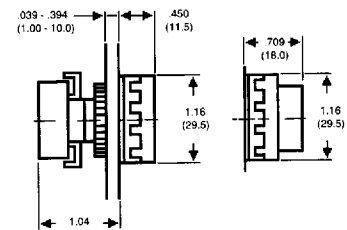
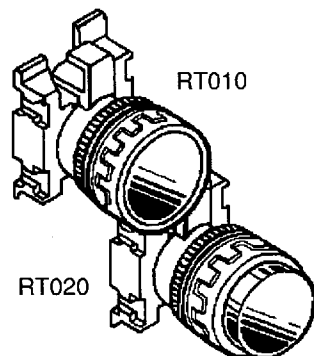

SPECIFICATIONS SUBJECT TO CHANGE WITHOUT NOTICE.

RELIANT'22 SERIES

7/8"(22mm) Oil-Tight • Round • Mushroom • Dual

A-25-21

MOMENTARY

Mushroom

Contact blocks not supplied, order separately.
(See page H6.)

MODEL	TYPE	BUSHING
RM0502	MUSHROOM, RED	METAL, BAYONET
RT0502	MUSHROOM, RED	THERMOPLASTIC, THREADED BUSHING
RM0500	MUSHROOM, BLACK	METAL, BAYONET
RT0500	MUSHROOM, BLACK	THERMOPLASTIC, THREADED BUSHING
RM0552	MUSHROOM, RED	METAL, BAYONET

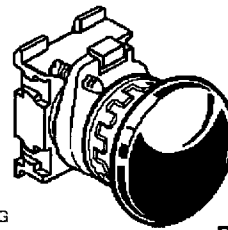

RM0502

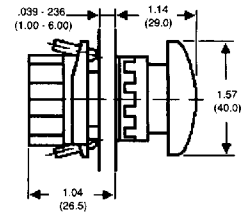

NOTE: FRONT BEVELED FRAME IS BLACK.

PUSH-TO-LOCK, TWIST-RELEASE

Metal Bushings

Contact blocks not supplied, order separately.
(See page H6.)

Note: Use F40/V40 for N.C. contacts,
and FAO/VAO for N.O. contacts.

MODEL	TYPE	ARROW
RM0652	MUSHROOM, RED	WHITE

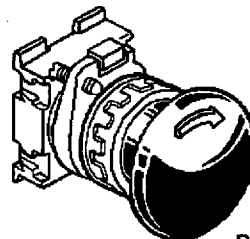

RM0652

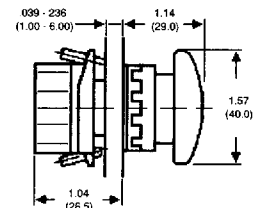

NOTE: FRONT BEVELED FRAME IS BLACK.

MAINTAINED

Contact blocks not supplied, order separately.
(See page H6.)

Note: Use F40/V40 for N.C. contacts
and FAO/VAO for N.O. contacts.

MODEL	TYPE
RM030(*)	FLUSH BOTTOM
RM0450	MUSHROOM, BLACK
RM0452	MUSHROOM, RED
RM0532	PUSH-PULL, MUSHROOM, RED
RM0530	BLACK

(*) SPECIFY COLOR BY ADDING SUFFIX NUMBER: (0)BLACK, (2)RED,
(4)YELLOW, (5)GREEN, (6)BLUE, (8)GREY, (9)WHITE.
NOTE: FRONT BEVELED FRAME IS BLACK.

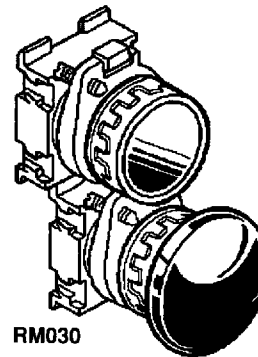

RM030

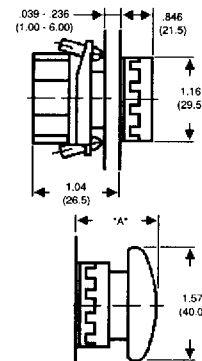

MOMENTARY DUAL OPERATOR*

Threaded Thermoplastic Bushing

Contact blocks not supplied, order separately.
(See page H6.)

Seal, blank buttons available. Other legends available.

MODEL	COLOR	LEGEND
QT0120I	GREEN, RED	AS SHOWN
QT0120IH	GREEN, RED	O & I HORIZONTAL
QT0120NOFF	GREEN, RED	ON & OFF VERTICAL
QT0120NOFFH	GREEN, RED	ON & OFF HORIZONTAL
QT012STST	GREEN, RED	START & STOP VERTICAL
QT012STSTH	GREEN, RED	START & STOP HORIZONTAL

* NOT OIL TIGHT CONSTRUCTION, NOT SEALED; MEETS NEMA 1 ONLY.
NOTE: FRONT BEVELED FRAME IS BLACK.

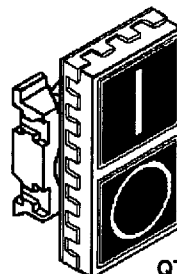

QT0120I

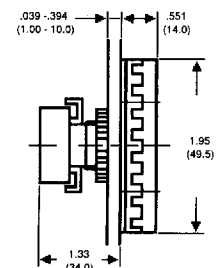

SPECIFICATIONS SUBJECT TO CHANGE WITHOUT NOTICE.



Alcoswitch®

1551 Osgood Street

N. Andover, MA 01845 USA

Tel: (508)685-4371

FAX: (508)686-9545

TLX: 275423

H2

A-25-21
A-25-03

RELIANT'22

Momentary • Maintained • Pushbuttons

MOMENTARY

Metal Bushings

Contact blocks not supplied, order separately.
(See page H6.)

MODEL TYPE

QM010(*) FLUSH BUTTON
QM020(*) EXTENDED BUTTON
(*) SPECIFY COLOR BY ADDING SUFFIX NUMBER: (0)BLACK, (2)RED, (4)YELLOW, (5)GREEN, (6)BLUE, (8)GREY, (9)WHITE.
NOTE: FRONT BEVELED FRAME IS BLACK.

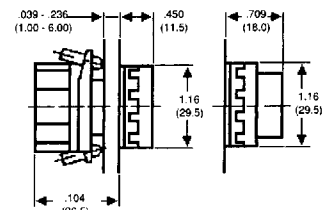
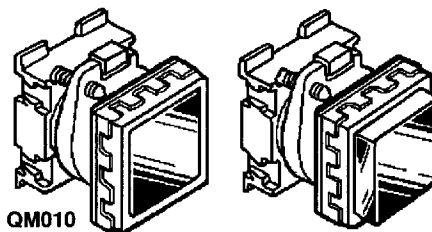

QM010

MOMENTARY

Thermoplastic Bushings (Threaded)

Contact blocks not supplied, order separately.
(See page H6.)

MODEL TYPE

QT010(*) FLUSH BUTTON
QT020(*) EXTENDED BUTTON
(*) SPECIFY COLOR BY ADDING SUFFIX NUMBER: (0)BLACK, (2)RED, (4)YELLOW, (5)GREEN, (6)BLUE, (8)GREY, (9)WHITE.
NOTE: FRONT BEVELED FRAME IS BLACK.

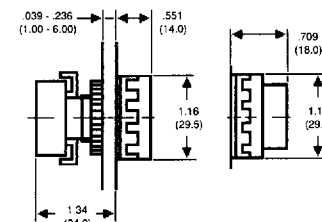
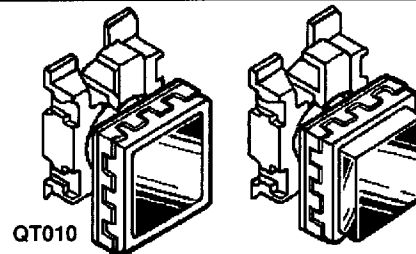

QT010

RELIANT'22

7/8" Oil-Tight • Selectors • Keylocks

2 POSITION SELECTOR/KEYLOCK MAINTAINED

Metal Bushings

Contact blocks not supplied, order separately.
(See page H6.)

MODEL ACTION CAM REMOVE KEY

RM4040 MAINTAINED, BLACK 1
RM3040 MAINTAINED, BLACK 1
RM200 MAINTAINED 1
RM201 MAINTAINED 1
RM250 MOMENTARY, RIGHT 1
RM204
RM205
E1 SPARE KEY

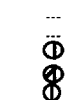

60°
60° Throw between positions.

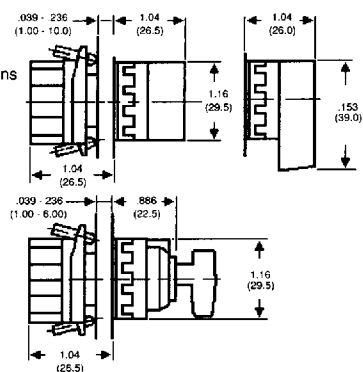
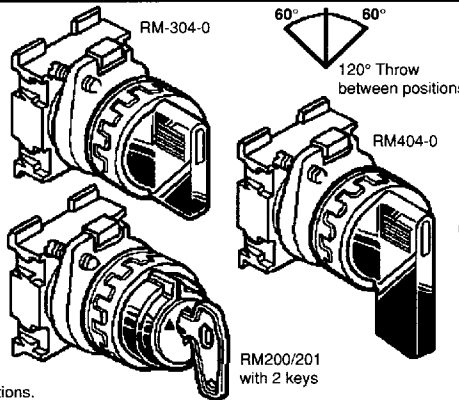

3 POSITION SELECTORS

Short Handle

Metal Bushings

Contact blocks not supplied, order separately.
(See page H6.)

MODEL ACTION CAM.

RM3100 MAINTAINED, BLACK 2
RM3120 MAINTAINED, BLACK 3
RM3130 MAINTAINED, BLACK 4
RM3700 MOMENTARY, RIGHT SIDE, BLACK 2
RM3720
RM3800 DOUBLE MOMENTARY, BLACK 2
RM3830

NOTE: FRONT BEVELED FRAME IS BLACK.
OTHER OPTIONS AVAILABLE. CONSULT THE FACTORY.

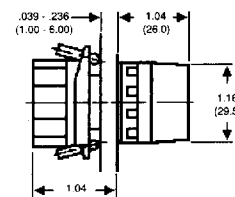
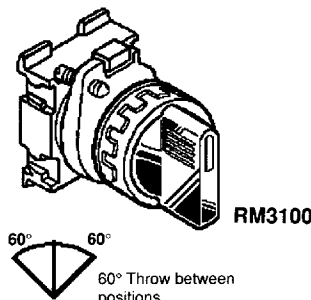

60° 60°
60° Throw between positions

3 POSITION SELECTORS

Long Handle, Metal Bushings

Contact blocks not supplied, order separately.
(See page H6.)

MODEL ACTION CAM.

RM4100 MAINTAINED 2
RM4120 MAINTAINED 3
RM4130 MAINTAINED 4
RM4700 MOMENTARY, RIGHT SIDE 2
RM4800 DOUBLE MOMENTARY 2
RM482
RM483

NOTE: FRONT BEVELED FRAME IS BLACK.
OTHER OPTIONS AVAILABLE. CONSULT THE FACTORY.

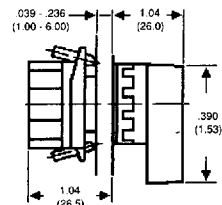
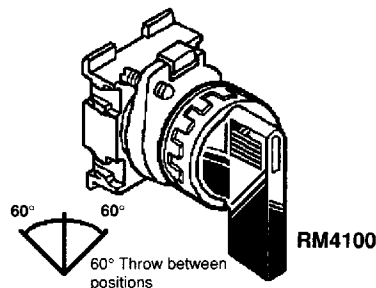

60° 60°
60° Throw between positions

SPECIFICATIONS SUBJECT TO CHANGE WITHOUT NOTICE.

A-25-D3
A-25-19

RELIANT'22

7/8" 22 MM Oil-Tight • Selector • Keylock

3 POSITION KEYLOCK SELECTOR MAINTAINED OR MOMENTARY

Metal Bushings

Contact blocks not supplied, order separately.
(See page H6.)

MODEL	ACTION	CAM	REMOVE KEY
RM210	MAINTAINED	2	⊙
RM220	MAINTAINED	2	⊙
RM222	MAINTAINED	3	⊙
RM230	MAINTAINED	2	⊙
RM232	MAINTAINED	3	⊙
RM233	MAINTAINED	4	⊙
RM240	MAINTAINED	2	⊙
RM243	MAINTAINED	4	⊙
RM270	MOM. RIGHT SIDE	2	⊙
RM272	MOM. RIGHT SIDE	3	⊙
RM273	MOM. RIGHT SIDE	4	⊙
RM280	MOM. BOTH SIDES	2	⊙
RM283	MOM. BOTH SIDES	4	⊙
E1	SPARE KEY		⊙

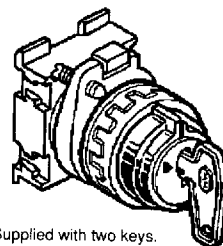

Supplied with two keys.

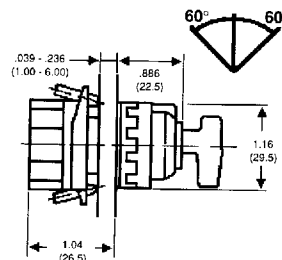

NOTE: FRONT BEVELED FRAME IS BLACK. OTHER OPTIONS AVAILABLE. CONSULT THE FACTORY.

PILOT LIGHTS (Full voltage type)

Lamps: order separately, miniature bayonet base.

Lamps: use G3 1/2 on QM600(*), use T3 1/4 on SR601(*), RM600 (*)
Custom Legends Available

MODEL	TYPE
QM600(*)	SQUARE PILOT LIGHT, METAL BUSHING
SR601(*)	ROUND PILOT LIGHT, PLASTIC BUSHING SCREW TURN
RM600(*)	ROUND PILOT LIGHT, METAL BUSHING
SR601F(*)	ROUND PILOT LIGHT, PLASTIC BUSHING
	1/4" QUICK CONNECTS.
QT600(*)	SQUARE PILOT LIGHT PLASTIC BUSHING

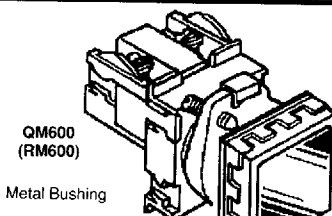

Metal Bushing

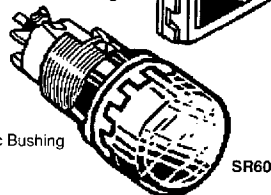

Threaded Thermoplastic Bushing
Front lampable

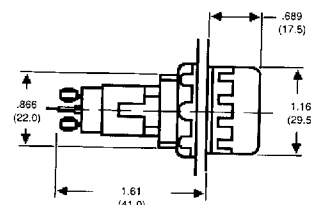
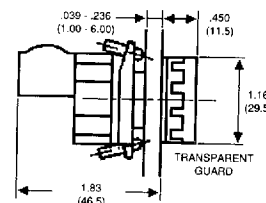

RELIANT'22

Illuminated Pushbuttons, Selectors

ROUND MOMENTARY/MAINTAINED

Metal Bushing

Contact blocks not supplied, order separately. (See page H6.)

Lamp circuit isolated. Order lamp separately. (See page H13.)

Lamps: Use T-3 1/4 or G3 1/2 incandescent or neon lamps.

MODEL	ACTION	TYPE
RM120(*)	MOMENTARY	EXTENDED BUTTON
RM122(*)	MOMENTARY	GUARDED BUTTON
RM130(*)	MAINTAINED	FLUSH BUTTON
RM145(*)	MAINTAINED	MUSHROOM
RM150(*)	MOMENTARY	MUSHROOM
RM1652	TWIST RELEASE	MUSHROOM, RED
ILLUMINATED SELECTORS		
RM650(*)	MAINTAINED	2-POS. SELECTOR**
RM653(*)	MAINTAINED	3-POS. SELECTOR**
RM655(*)	MAINTAINED	2-POS. SELECTOR**

When operating from line voltage use
step down transformers 5B0 or 570.

(*)SPECIFY COLOR BY ADDING SUFFIX NUMBER: (2)RED, (4)YELLOW,
(5)GREEN, (6)BLUE, (9)WHITE. NOTE: RM145 AND RM150 AVAILABLE
ONLY IN RED, YELLOW, GREEN.

**USE G3 1/2 LAMPS ONLY.

NOTE: FRONT BEVELED FRAME IS BLACK.

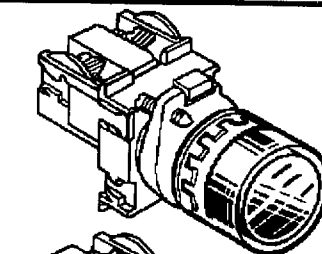

Front lampable

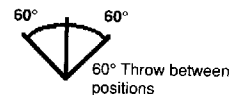
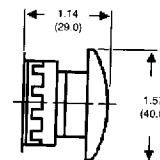
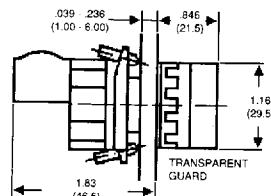
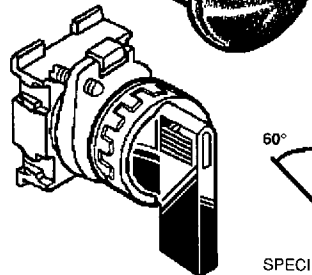
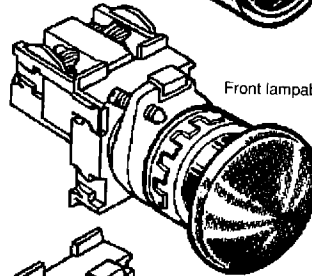

SPECIFICATIONS SUBJECT TO CHANGE WITHOUT NOTICE.



Alcoswitch®

1551 Osgood Street

N. Andover, MA 01845 USA

Tel: (508)685-4371

FAX: (508)686-9545

TLX: 275423

H4

A-25-19

RELIANT'22

Illuminated Pushbuttons

SQUARE, MOMENTARY

Metal Bushing

Contact blocks not supplied, order separately. (See page H6.)
 Lamp circuit isolated. Order lamps separately.
 Lamps: Use G3 1/2.
 Custom Legends Available.

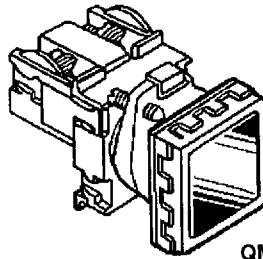

QM122

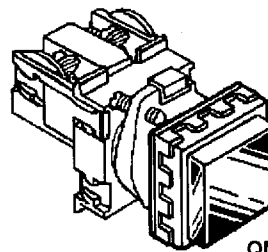
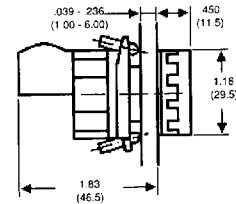

QM120

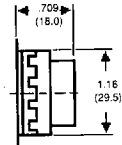

MODEL	TYPE
QM122(*)	FLUSH BUTTON
QM120(*)	EXTENDED BUTTON

(*)SPECIFY COLOR BY ADDING SUFFIX NUMBER: (2)RED, (4)YELLOW, (5)GREEN, (6)BLUE, (9)WHITE.
 NOTE: FRONT BEVELED FRAME IS BLACK.

ROUND, MOMENTARY

Thermoplastic

Contact blocks not supplied, order separately. (See page H6.)
 Lamp circuit isolated. Order lamps separately. (See page H13.)
 Lamps: use T-3 1/4 or G3 1/2 incandescent or neon lamps.

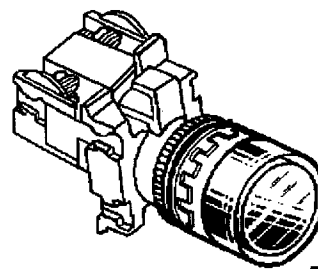

RT120

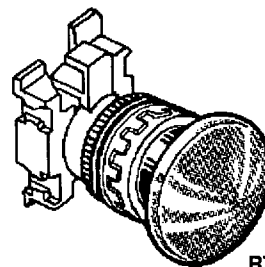
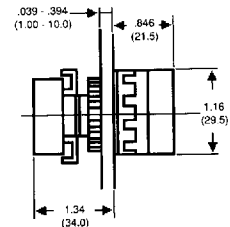

RT150

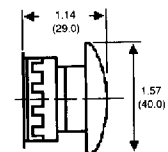

MODEL	ACTION	TYPE
RT120(*)	MOMENTARY	EXTENDED BUTTON
RT150(*)	MAINTAINED	MUSHROOM

(*)SPECIFY COLOR BY ADDING SUFFIX NUMBER: (2)RED, (4)YELLOW, (5)GREEN, (6)BLUE, (9)WHITE.
 NOTE: RT145 AND RT150 AVAILABLE ONLY IN RED, YELLOW, GREEN.
 NOTE: FRONT BEVELED FRAME IS BLACK.

SPECIFICATIONS SUBJECT TO CHANGE WITHOUT NOTICE.

SERIES 6000 AND RELIANT'22

Lamps • Transformer

A 09-19

LAMPS

The lamps with G31/2 bulbs fit all Reliant 22, Series 6000 illuminated operators and pilot lights. Lamps with T31/4 fit all Reliant 22 and Series 6000 illuminated models (except QM120, QM122, and M6650, and M6655).

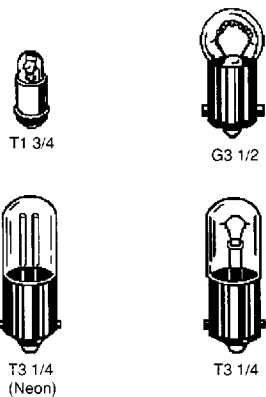

MODEL	BULB	RATED VOLTS	DESIGN AMPS	MSCP	AVERAGE RATED HOURS
381	T13/4	6.3	.20	.40	50,000
382	T13/4	14	.08	.30	50,000
387	T13/4	28	.04	.30	25,000
130	G31/2	6.3	.15	.36	5,000
1445	G31/2	14.4	.136	.70	2,000
755	T31/4	6.3	.15	.33	20,000
756	T31/4	14	.08	.31	15,000
757	T31/4	28	.08	.62	7,500
*NE51HR	T31/4	120	(NEON)	BRIGHT	25,000
*NE51HRZ	T31/4	120	(NEON)	EX. BRIGHT	15,000

*NOT RECOMMENDED FOR USE WITH GREEN OR BLUE LENSES.

STEP-DOWN TRANSFORMERS

AC LINE TO 6V/6.3V

Snap mount on lighted operators and QM600, T6632 and RM600 pilot lights. Spade tipped leads connect to lamp terminals on operator. Screw terminals on primary. Use 6-6.3V lamps. 0-9 to 1.35 watts. Secondary winding is energy-limited.

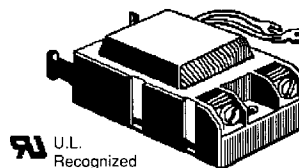

MODEL PRIMARY VOLTAGE

5B0	110-120 VAC
570	220-240 VAC

PANEL LAYOUTS

RELIANT'22

MINIATURE MODELS

Recommended hole mounting dimensions*

MINIMUM CENTER-TO-CENTER SPACING (INCHES)

OPERATOR TYPE	A	B
PUSHBUTTONS, PILOTS	1.19/30.2	1.66/42.2
MUSHROOM, SELECTOR	1.50/37.8	1.66/42.2
OTHERS	1.94/49.3	1.94/49.3

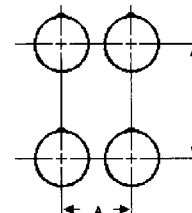
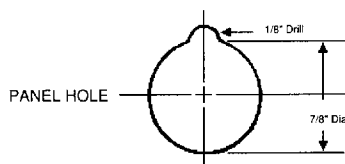

* CHECK DIMENSIONS FOR LAYOUTS USING LEGEND PLATES.

SERIES 6000 STANDARD MODELS

Recommended hole mounting dimensions*

MINIMUM CENTER-TO-CENTER SPACING (INCHES)

OPERATOR TYPE	A	B
PUSHBUTTONS, PILOTS	1.88/47.8	1.97/50.0
MUSHROOM, SELECTOR	2.25/57.2	2.25/57.2
LARGE MUSHROOM	3.00/76.2	3.00/76.2

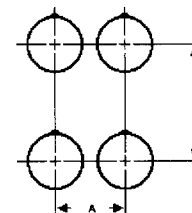
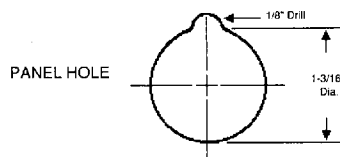

* CHECK DIMENSIONS FOR LAYOUTS USING LEGEND PLATES.

SPECIFICATIONS SUBJECT TO CHANGE WITHOUT NOTICE.



Alcoswitch®

1551 Osgood Street

N. Andover, MA 01845 USA

Tel: (508)685-4371

FAX: (508)686-9545

TLX: 275423