

# PT460/PT460F/PT461 PT461F/PT465F

## Duble-end Type Phototransistor

### ■ Features

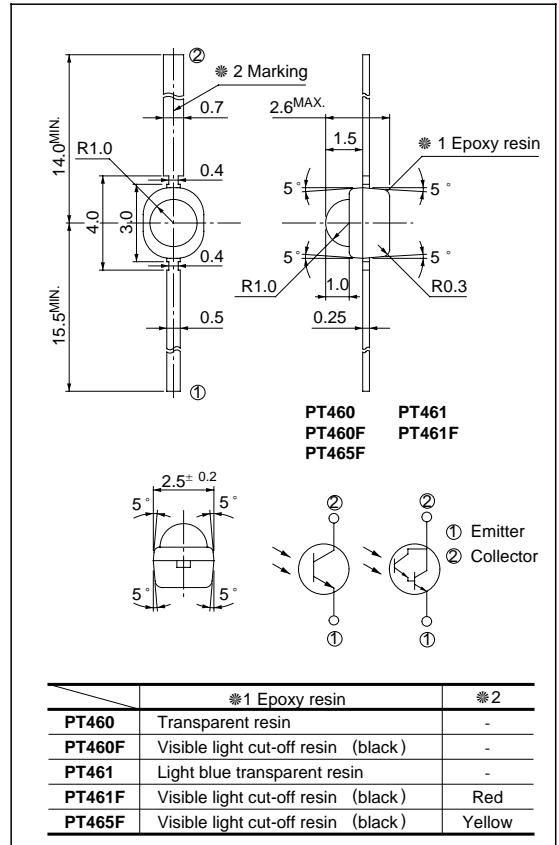
1. Compact double-end type package
2. Taping package (2 000pcs./reel) (PT xxx T)
3. Visible light cut-off type  
(PT460F / PT461F / 465F)

### ■ Applications

1. Floppy disk drives
2. VCRs
3. Audio equipment

### ■ Outline Dimensions

(Unit : mm)



### ■ Absolute Maximum Ratings

(Ta = 25°C)

Parameter	Symbol	Rating	Unit
Collector-emitter voltage	V <sub>CEO</sub>	35	V
Emitter-collector voltage	V <sub>ECO</sub>	6	V
Collector current	*1	20	mA
	*2	50	
Collector power dissipation	*1	50	mW
	*2	100	
Operating temperature	T <sub>opr</sub>	-25 to +85	°C
Storage temperature	T <sub>stg</sub>	-40 to +85	°C
*3Soldering temperature	T <sub>sol</sub>	260	°C

\*1 **PT460/460F/465F**\*2 **PT461/461F**

\*3 For 3 seconds at the position of 2.5mm from the edge of resin package

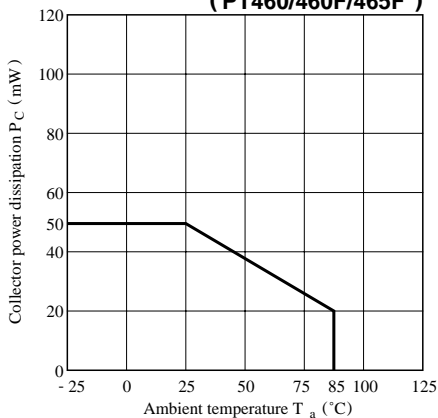
## Electro-optical Characteristics

(T<sub>a</sub> = 25°C)

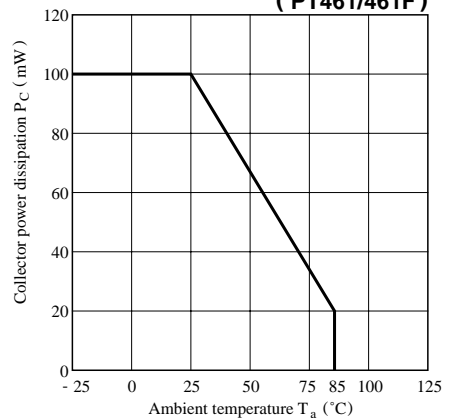
Parameter		Symbol	Conditions	MIN.	TYP.	MAX.	Unit	
Collector current	PT460	I <sub>C</sub>	<sup>*4</sup> E <sub>e</sub> = 1mW/cm <sup>2</sup> V <sub>CE</sub> = 5V	0.18	-	1.20	mA	
	PT460F			0.11	-	0.90		
	PT465F			0.11	-	0.50		
	PT461		<sup>*4</sup> E <sub>e</sub> = 0.01mW/cm <sup>2</sup> V <sub>CE</sub> = 5V	0.20	-	1.20		
	PT461F			0.14	-	0.98		
Collector dark current	PT460/460F/465F	I <sub>CEO</sub>	E <sub>e</sub> = 0, V <sub>CE</sub> = 20V	-	-	0.1	μA	
	PT461/461F		E <sub>e</sub> = 0, V <sub>CE</sub> = 10V	-	-	1.0		
Collector-emitter saturation voltage	PT460/PT460F	V <sub>CE(sat)</sub>	E <sub>e</sub> = 10mW/cm <sup>2</sup> I <sub>C</sub> = 0.5mA	-	0.2	0.4	V	
	PT465F		E <sub>e</sub> = 1mW/cm <sup>2</sup> I <sub>C</sub> = 2.5mA	-	-	1.2		
	PT461/PT461F							
Collector-emitter breakdown voltage		BV <sub>CEO</sub>	I <sub>C</sub> = 0.1mA, E <sub>e</sub> = 0	35	-	-	V	
Emitter-collector breakdown voltage		BV <sub>ECO</sub>	I <sub>C</sub> = 0.01mA, E <sub>e</sub> = 0	6	-	-	V	
Peak sensitivity wavelength		PT460/PT461	λ <sub>p</sub>	-	-	800	-	nm
		PT460F/461F/465F			-	860	-	
Response time	Rise time	PT460/460F/465F	t <sub>r</sub>	V <sub>CE</sub> = 20V, I <sub>C</sub> = 1mA R <sub>L</sub> = 1kΩ	-	10	40	μs
	Fall time				t <sub>f</sub>	-	8	
Response time	Rise time	PT461/461F	t <sub>r</sub>	V <sub>CE</sub> = 2V, I <sub>C</sub> = 10mA R <sub>L</sub> = 100Ω	-	400	2 000	μs
	Fall time				t <sub>f</sub>	-	300	
Half sensitivity angle		Δθ	-	-	± 50	-	°	

\*4 E<sub>e</sub> : Irradiance by CIE standard light source A (Tungsten Lamp)

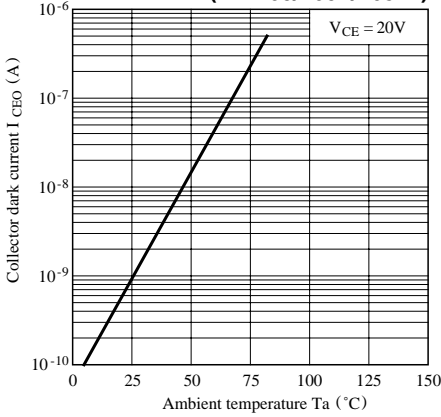
**Fig. 1-a Collector Power Dissipation vs. Ambient Temperature**  
(PT460/460F/465F)



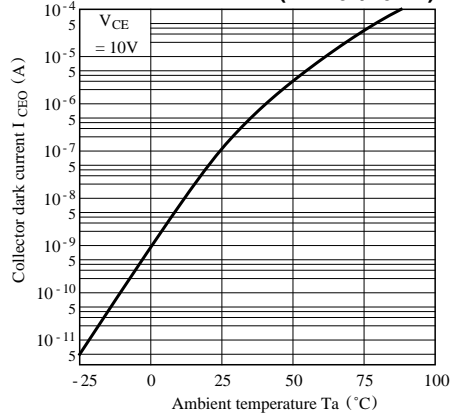
**Fig. 1-b Collector Power Dissipation vs. Ambient Temperature**  
(PT461/461F)



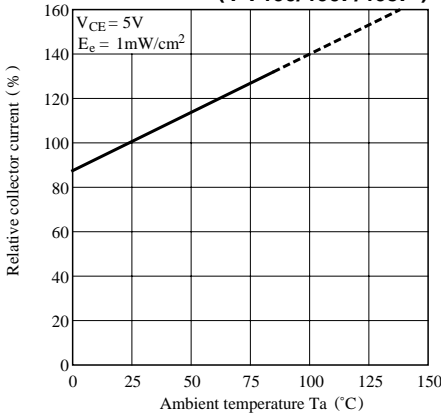
**Fig. 2-a Collector Dark Current vs. Ambient Temperature (PT460/460F/465F)**



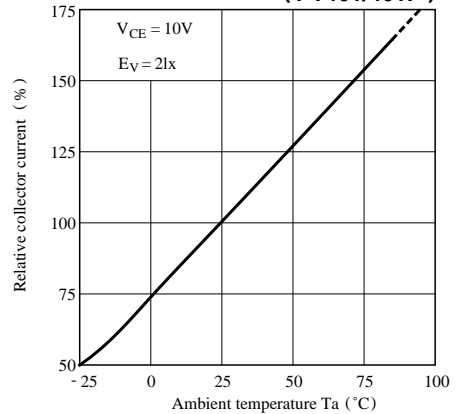
**Fig. 2-b Collector Dark Current vs. Ambient Temperature (PT461/461F)**



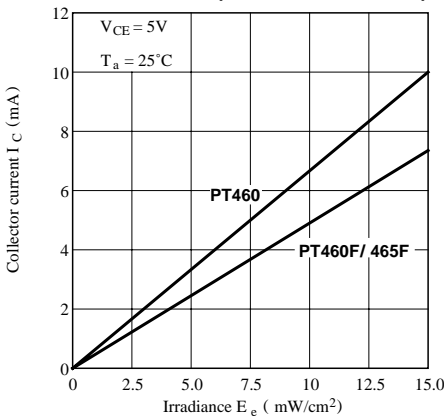
**Fig. 3-a Relative Collector Current vs. Ambient Temperature (PT460/460F/465F)**



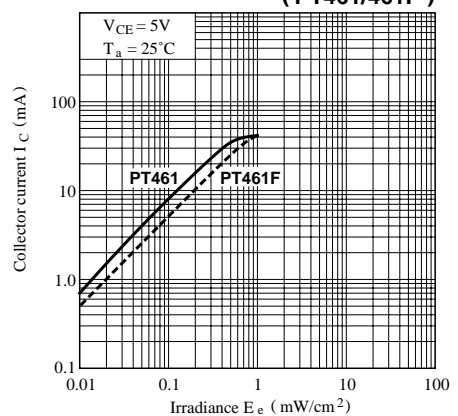
**Fig. 3-b Relative Collector Current vs. Ambient Temperature (PT461/461F)**



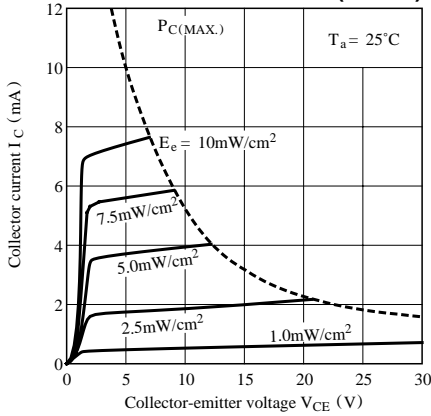
**Fig. 4-a Collector Current vs. Irradiance (PT460/460F/465F)**



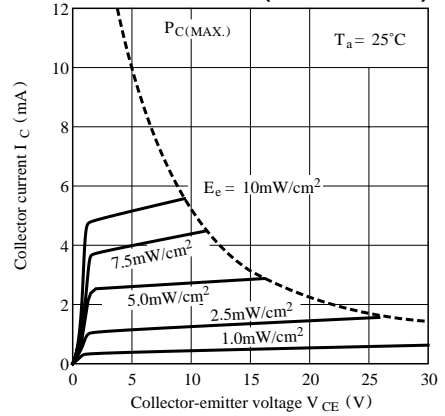
**Fig. 4-b Collector Current vs. Irradiance (PT461/461F)**



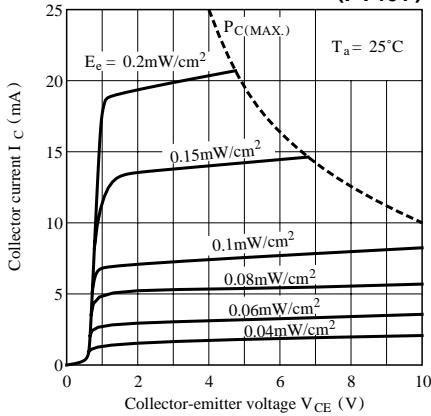
**Fig. 5-a Collector Current vs. Collector-emitter Voltage (PT460)**



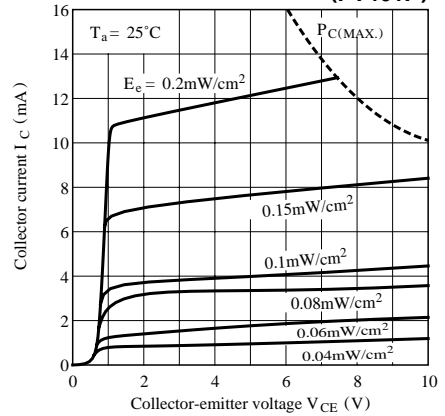
**Fig. 5-b Collector Current vs. Collector-emitter Voltage (PT460F/465F)**



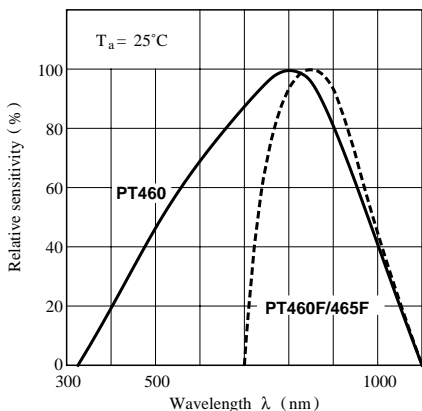
**Fig. 5-c Collector Current vs. Collector-emitter Voltage (PT461)**



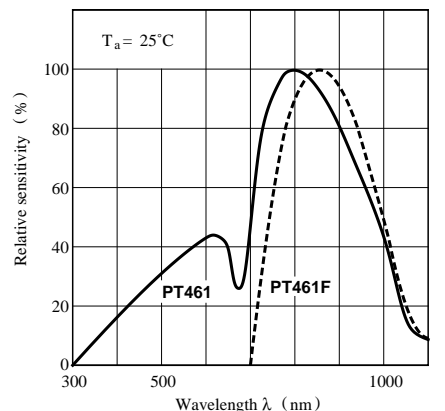
**Fig. 5-d Collector Current vs. Collector-emitter Voltage (PT461F)**



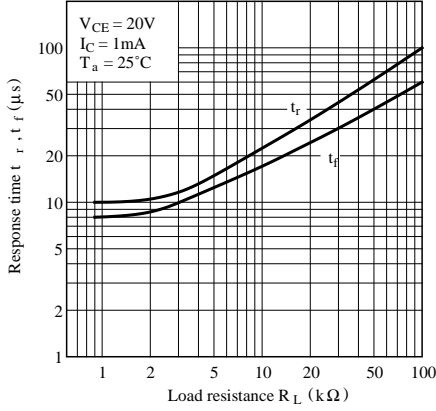
**Fig. 6-a Spectral Sensitivity (PT460/460F/465F)**



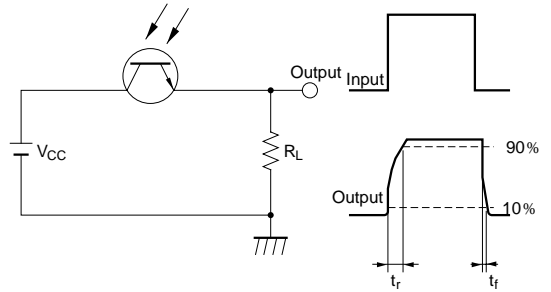
**Fig. 6-b Spectral Sensitivity (PT461/461F)**



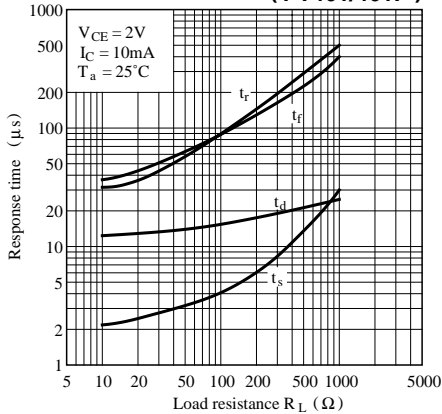
**Fig. 7-a Response Time vs. Load Resistance**  
(PT460/PT460F/465F)



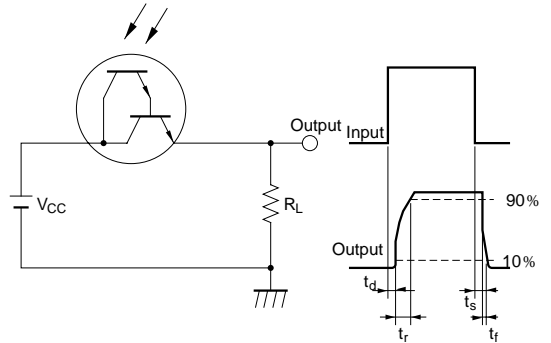
**Test Circuit for Response Time**  
(PT460/460F/465F)



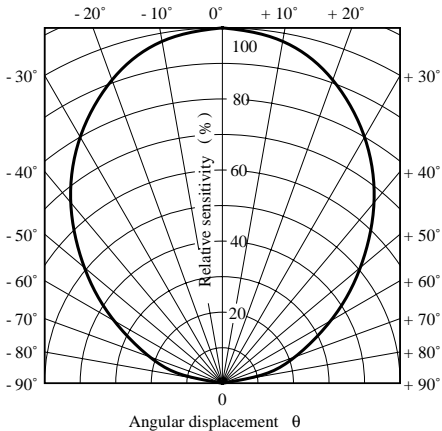
**Fig. 7-b Response Time vs. Load Resistance**  
(PT461/461F)



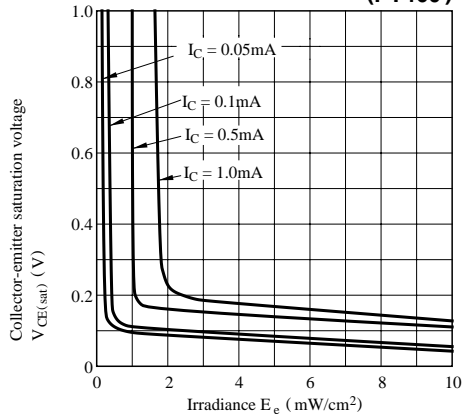
**Test Circuit for Response Time**  
(PT461/461F)

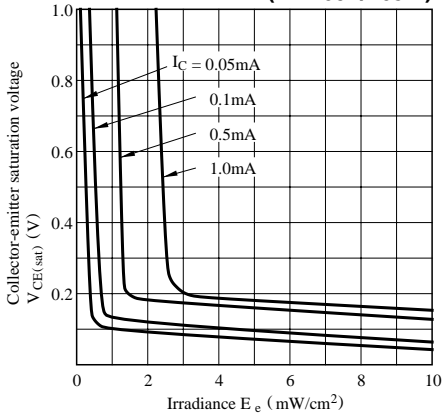
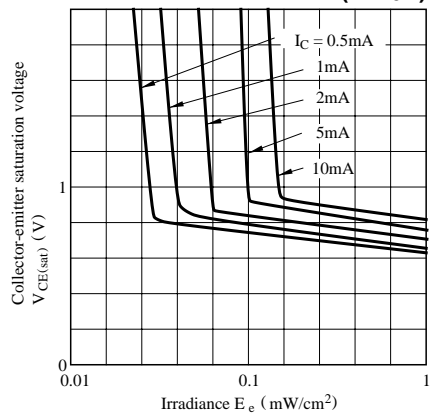
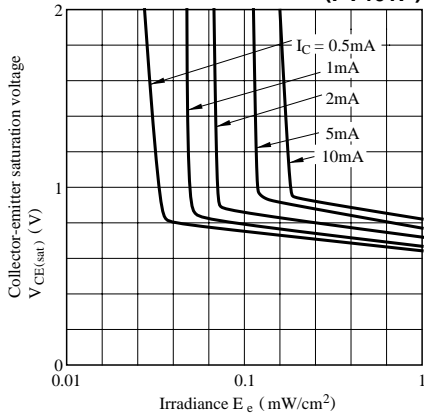


**Fig. 8 Sensitivity Diagram**

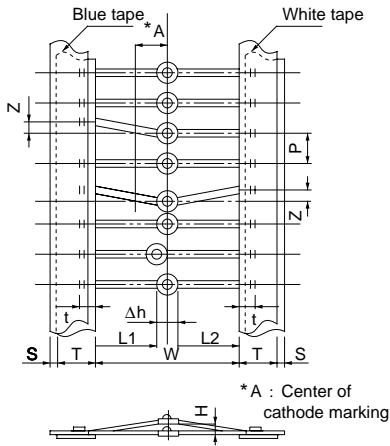


**Fig. 9-a Collector-emitter Saturation Voltage vs. Irradiance**  
(PT460)



**Fig. 9-b Collector-emitter Saturation Voltage vs. Irradiance (PT460F/465F)****Fig. 9-c Collector-emitter Saturation Voltage vs. Irradiance (PT461)****Fig. 9-d Collector-emitter Saturation Voltage vs. Irradiance (PT461F)**

## ■ Taping Specifications (PT<sub>XXX</sub> T)

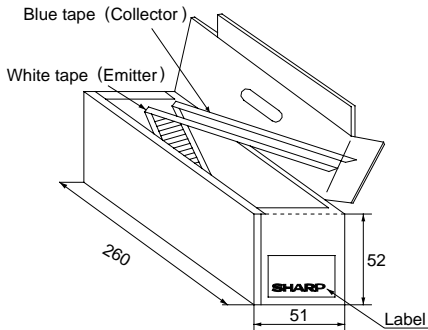


W	(Note 1) p	L2-L1	T	Z	Δ h	S	(Note 2) t	H	A
$26 \pm 1.5$ $0.0$	$5 \pm 0.5$ $0.5$	-	$6 \pm 10$ $10$	1.2 <sup>MAX</sup>	0.5 <sup>MAX</sup>	0.8 <sup>MAX</sup>	0.5 <sup>MIN</sup>	2.5 <sup>MAX</sup>	(4.5)

(Note 1) Tolerance of 20 pitches is  $\pm 2$ mm.

(Note 2) The lead's overlapping length on the tape.

## ■ Packing Specification (PT<sub>XXX</sub> T)



### (1) Packing form

#### Box type

- The tape is zigzag-folded with 50 pcs. of phototransistor per fold.
- Phototransistor inserting portions for 50 to 60 pcs. on the tape's starting and ending parts are not stuffed.
- For the taping of collector pin, blue tape is used, and for emitter pin, white tape is used.

### (2) Packing quantity

2 000 pcs. per box

● Please refer to the chapter "Precautions for Use."