

PTF 10125

135 Watts, 1.4–1.6 GHz

GOLDMOS™ Field Effect Transistor

Description

The PTF 10125 is an internally matched, common source N-channel enhancement-mode lateral MOSFET intended for linear driver and final applications from 1.4 to 1.6 GHz, such as DAB/DRB. It is rated at 135 watts minimum power output. Nitride surface passivation and full gold metallization ensure excellent device lifetime and reliability.

- **INTERNALLY MATCHED**
- **Performance at 1.5 GHz, 28 V**
 - Output Power = 135 Watts Min
 - Power Gain = 12.5 dB Typ
- **Full Gold Metallization**
- **Silicon Nitride Passivated**
- **Back Side Common Source**
- **Excellent Thermal Stability**
- **100% Lot Traceability**

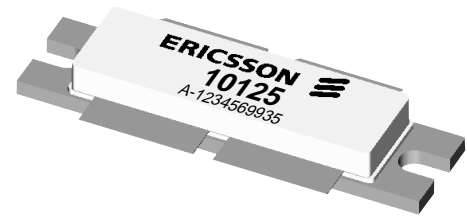
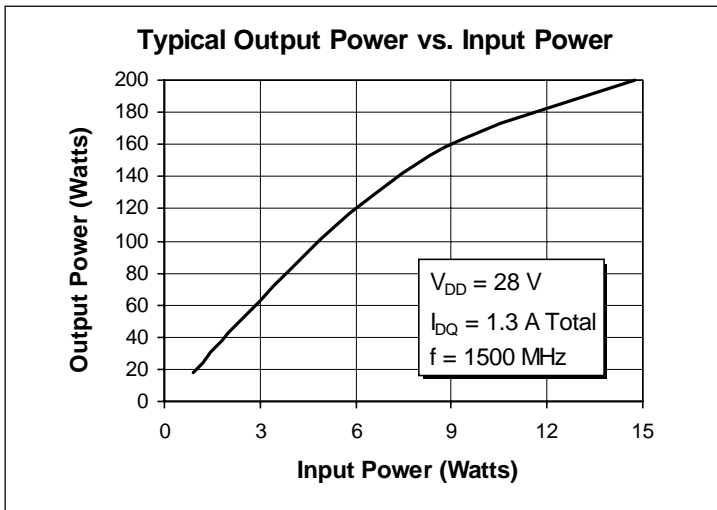

Package 20250

RF Specifications (100% Tested)

Characteristic	Symbol	Min	Typ	Max	Units
Gain ($V_{DD} = 28\text{ V}$, $P_{OUT} = 30\text{ W}$, $I_{DQ} = 1.3\text{ A Total}$, $f = 1.50, 1.55\text{ GHz}$)	G_{ps}	11.5	12.5	—	dB
Power Output at 1 dB Compression ($V_{DD} = 28\text{ V}$, $I_{DQ} = 1.3\text{ A Total}$, $f = 1.50, 1.55\text{ GHz}$)	P-1dB	135	150	—	Watts
Drain Efficiency ($V_{DD} = 28\text{ V}$, $P_{OUT} = 135\text{ W}$, $I_{DQ} = 1.3\text{ A Total}$, $f = 1.5\text{ GHz}$)	η_D	35	40	—	%
Load Mismatch Tolerance ($V_{DD} = 28\text{ V}$, $P_{OUT} = 67.5\text{ W}$, $I_{DQ} = 1.3\text{ A Total}$, $f = 1.5\text{ GHz}$ —all phase angles at frequency of test)	Ψ	—	—	10:1	—

All published data at $T_{CASE} = 25^\circ\text{C}$ unless otherwise indicated.

Electrical Characteristics (100% Tested—characteristics, conditions and limits shown per side)

Characteristic	Conditions	Symbol	Min	Typ	Max	Units
Drain-Source Breakdown Voltage	$V_{GS} = 0\text{ V}, I_D = 100\text{ mA}$	$V_{(BR)DSS}$	65	—	—	Volts
Zero Gate Voltage Drain Current	$V_{DS} = 28\text{ V}, V_{GS} = 0\text{ V}$	I_{DSS}	—	—	5.0	mA
Gate Threshold Voltage	$V_{DS} = 10\text{ V}, I_D = 150\text{ mA}$	$V_{GS(th)}$	3.0	—	5.0	Volts
Forward Transconductance	$V_{DS} = 10\text{ V}, I_D = 6\text{ A}$	g_{fs}	2.0	4.0	—	Siemens

Maximum Ratings

Parameter	Symbol	Value	Unit
Drain-Source Voltage ⁽¹⁾	V_{DSS}	65	Vdc
Gate-Source Voltage ⁽¹⁾	V_{GS}	± 20	Vdc
Operating Junction Temperature	T_J	200	$^{\circ}\text{C}$
Total Device Dissipation Above 25 $^{\circ}\text{C}$ derate by	P_D	440 2.51	Watts W/ $^{\circ}\text{C}$
Storage Temperature Range	T_{STG}	-40 to +150	$^{\circ}\text{C}$
Thermal Resistance ($T_{CASE} = 70^{\circ}\text{C}$)	$R_{\theta JC}$	0.39	$^{\circ}\text{C}/\text{W}$

⁽¹⁾per side

Typical Performance

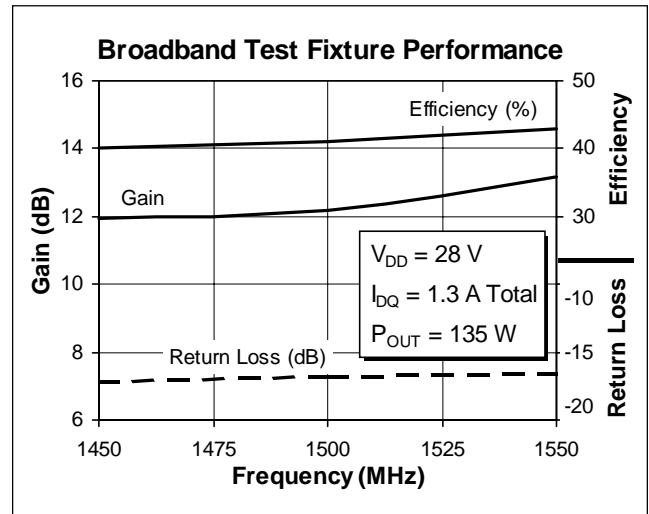
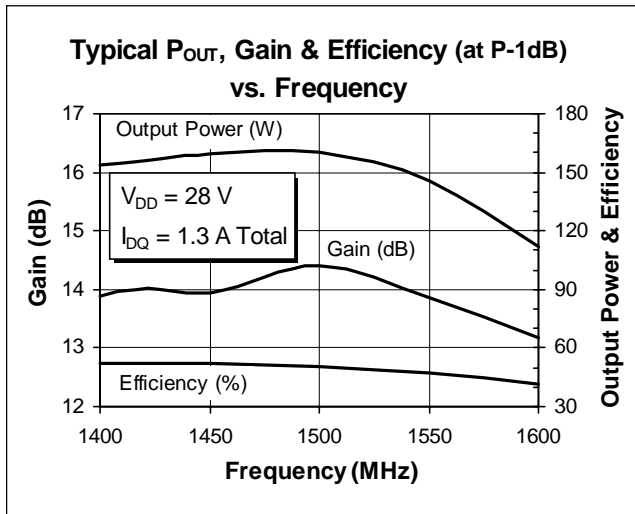

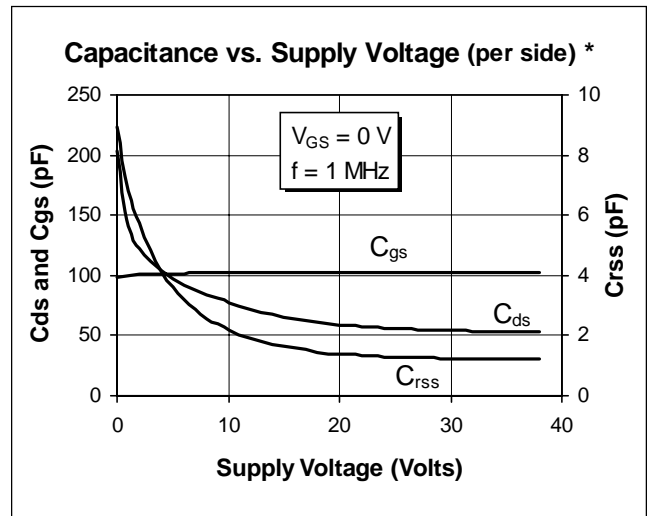
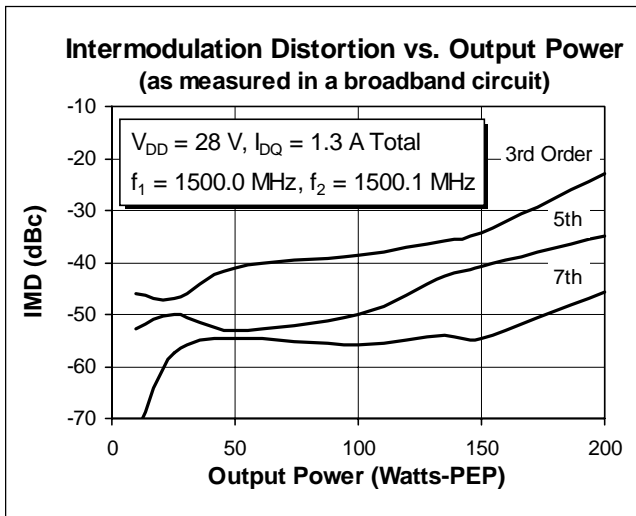
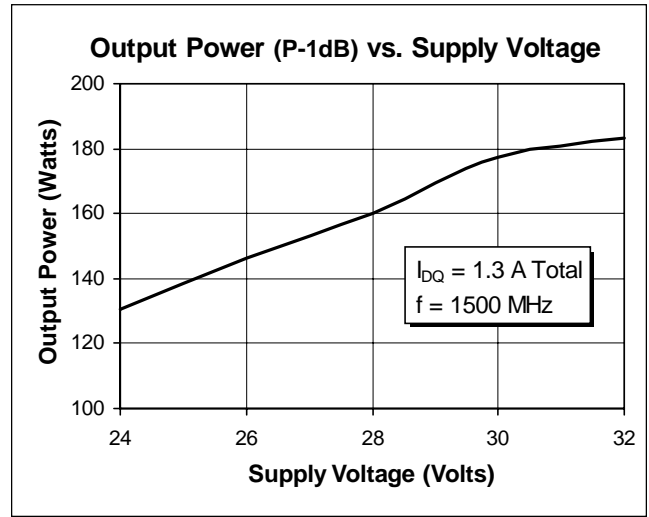
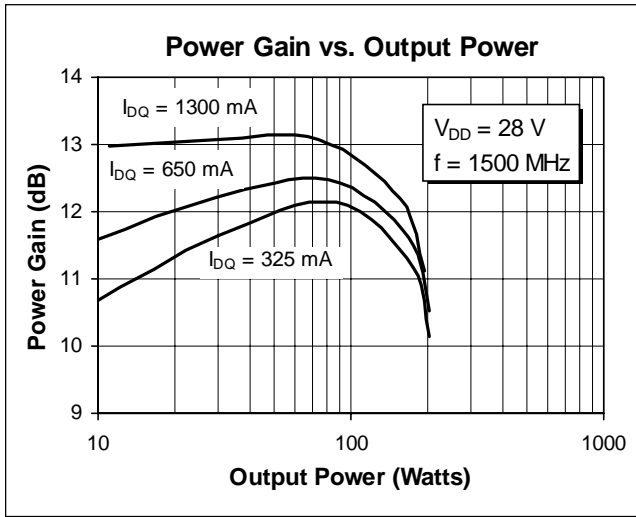

* This part is internally matched. Measurements of the finished product will not yield these results.

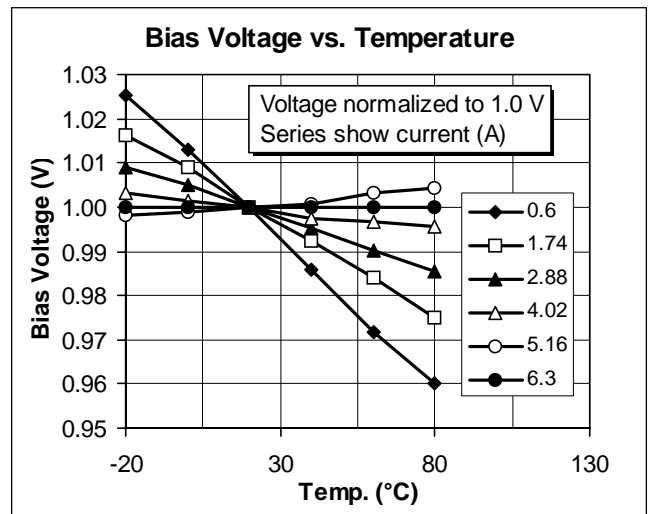
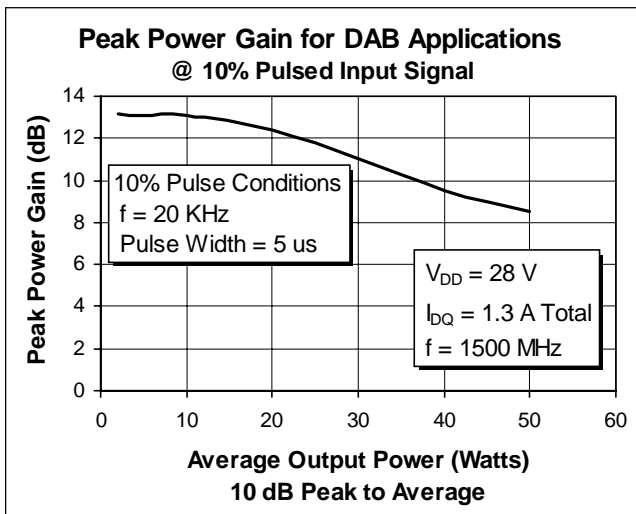

PTF 10125



Impedance Data

($V_{DD} = 28\text{ V}$, $P_{OUT} = 135\text{ W}$,
 $I_{DQ} = 1.3\text{ A Total}$)

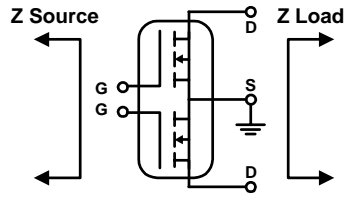

Frequency	Z Source Ω		Z Load Ω	
	R	jX	R	jX
1400	2.85	-4.23	2.60	-2.46
1450	4.16	-4.36	2.36	-2.53
1500	4.58	-3.30	2.04	-2.48
1550	4.02	-0.83	1.63	-2.52
1600	3.41	0.37	1.27	-2.08

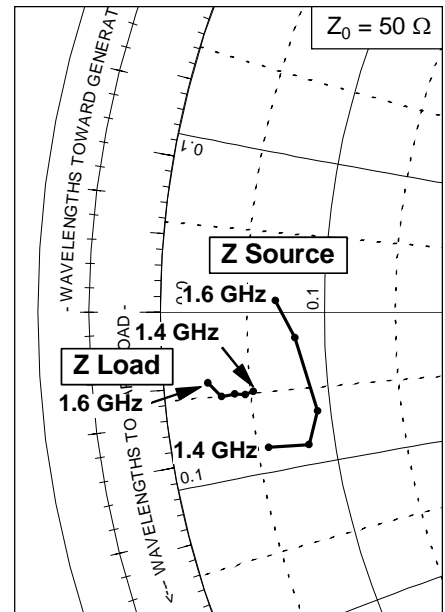

Test Circuit

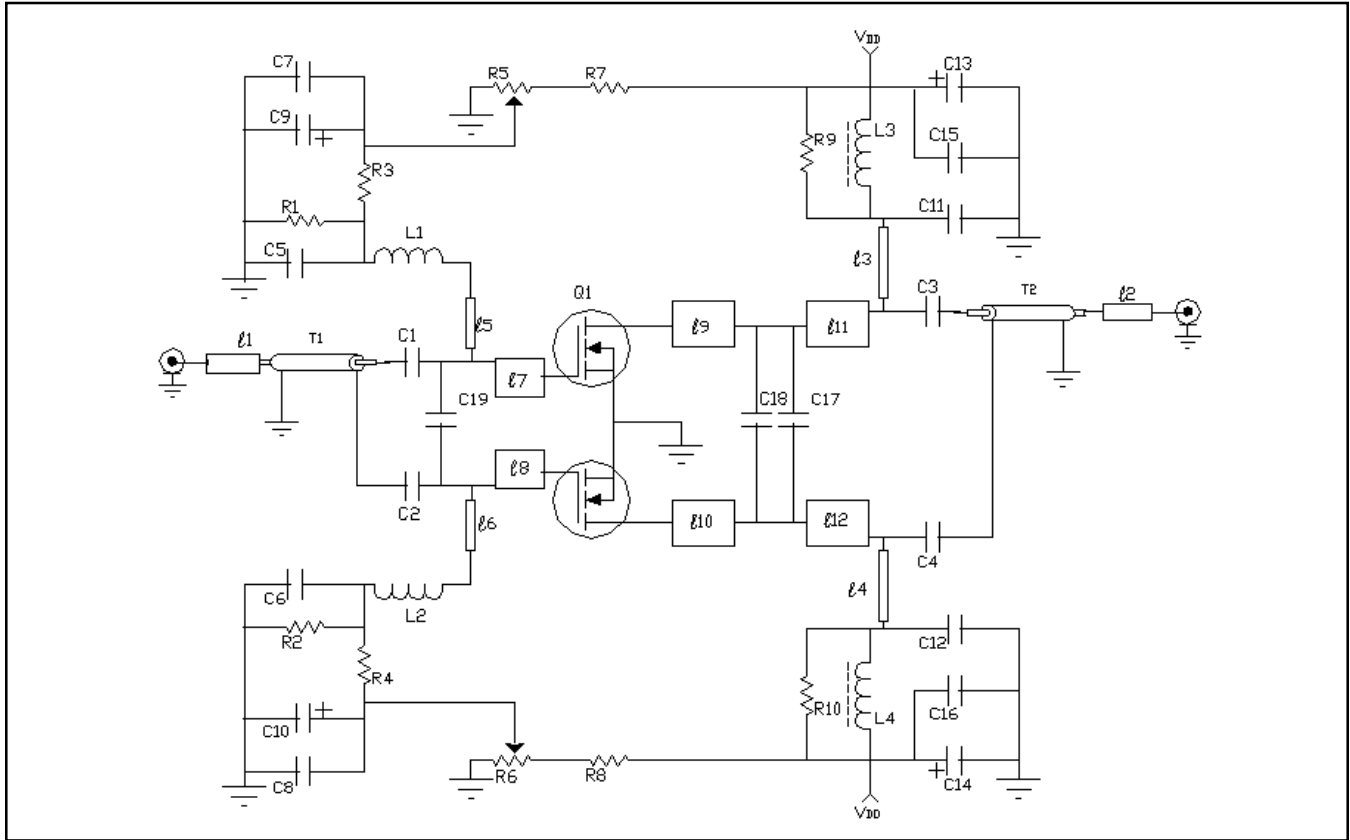

Test Circuit Block Diagram for $f = 1.5$ GHz

Q1	PTF 10125	LDMOS RF Transistor	L1, L2	2.7 nH SMT Coil	
$l1, l2$		Microstrip 50 Ω	L3, L4	4 mm SMT Ferrite Bead	
$l3, l4$.25 λ @ 1.5 GHz	Microstrip 70 Ω	R1, R2, R3, R4	220 Ω Chip Resistor	K1206
$l5, l6$.08 λ @ 1.5 GHz	Microstrip 80 Ω	R5, R6	2K SMT Potentiometer	
$l7, l8$.138 λ @ 1.5 GHz	Microstrip 9.5 Ω	R7, R8	10 Ω Chip Resistor	K1206
$l9, l10$.096 λ @ 1.5 GHz	Microstrip 7.7 Ω	R9, R10	1 Ω Chip Resistor	K1206
$l11, l12$.045 λ @ 1.5 GHz	Microstrip 7.7 Ω	T1, T2	50 Ω Coaxial Balun	
C1, C2, C3, C4, C7, C8, C11, C12	13 pF Chip Cap	ATC 100 B	Circuit Board	.028" Dielectric Thickness, $\epsilon_r = 4.0$, AlliedSignal, G200, 2 oz. copper	
C5, C6, C15, C16	0.1 μ F Chip Cap	K1206			
C9, C10, C13, C14	10 μ F SMT Tantalum Cap				
C17, C19	2.0 pF Chip Cap	ATC 100 B			
C18	0.3 pF Chip Cap	ATC 100 B			

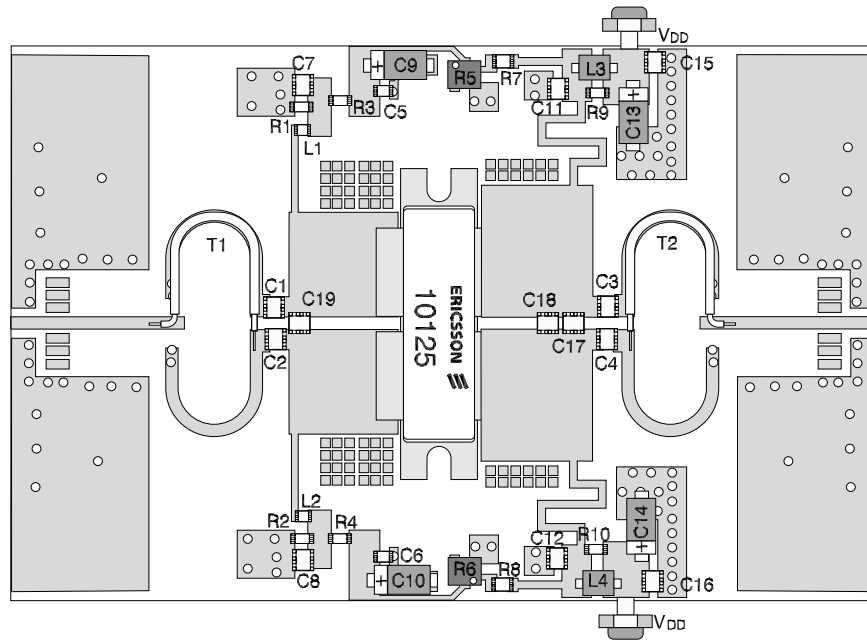

Parts Layout (not to scale)

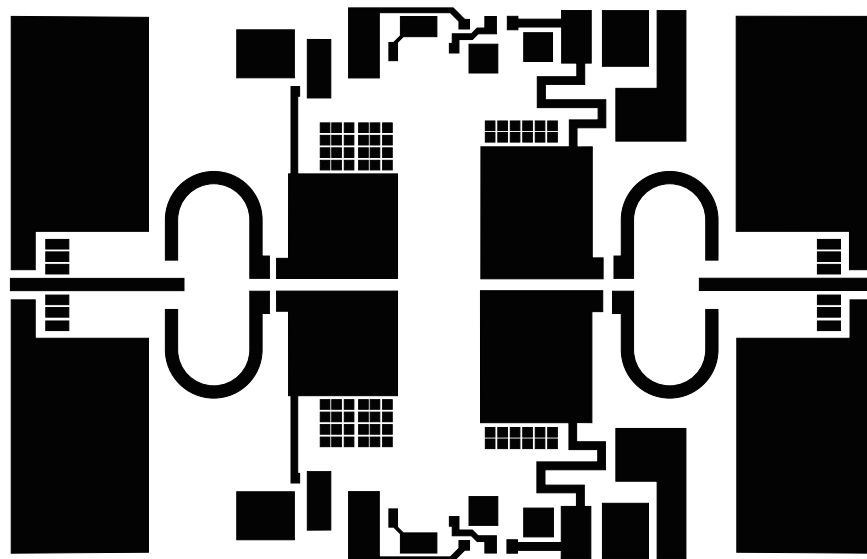

Artwork (1 inch )