

LDMOS RF Power Field Effect Transistor 180 W, 2110–2170 MHz

Description

The PTF211802 is a 180 W, internally matched, laterally double-diffused, *GOLDMOS* push-pull FET intended for WCDMA applications from 2110 to 2170 MHz. Full gold metallization ensures excellent device lifetime and reliability.

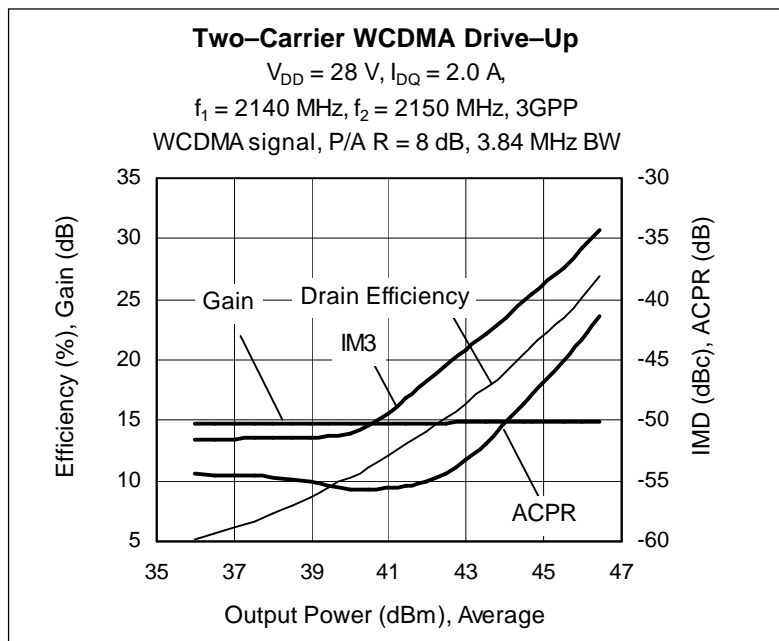

Features

- Broadband internal matching
- Typical two-carrier WCDMA performance
 - Average output power = 38 W
 - Gain = 15 dB
 - Efficiency = 25%
 - IM3 = -37 dBc
 - ACPR < -42 dBc
- Typical CW performance
 - Output power at P-1dB = 180 W
 - Efficiency = 50%
- Integrated ESD protection: Human Body Model, Class 1 (minimum)
- Excellent thermal stability
- Low HCI drift
- Capable of handling 10:1 VSWR @ 28 V, 180 W (CW) output power

PTF211802A
Package 20275



PTF211802E
Package 30275

ESD: Electrostatic discharge sensitive device — observe handling precautions!

RF Characteristics at $T_{CASE} = 25^\circ\text{C}$ unless otherwise indicated

WCDMA Measurements (not subject to production test—verified by design/characterization in Infineon test fixture)

$V_{DD} = 28\text{ V}$, $I_{DQ} = 2.0\text{ A}$, $P_{OUT} = 38\text{ W AVG}$

$f_1 = 2140\text{ MHz}$, $f_2 = 2150\text{ MHz}$, two-carrier 3GPP, channel bandwidth = 3.84 MHz, peak/average = 8 dB @ 0.01% CCDF

Characteristic	Symbol	Min	Typ	Max	Units
Intermodulation Distortion	IM3	—	-37	—	dBc
Gain	G_{ps}	—	15	—	dB
Drain Efficiency	η_D	—	25	—	%

Two-Tone Measurements (tested in Infineon test fixture)

$V_{DD} = 28\text{ V}$, $I_{DQ} = 2.0\text{ A}$, $P_{OUT} = 60\text{ W PEP}$, $f = 2110\text{ MHz}$, tone spacing = 5 MHz

Characteristic	Symbol	Min	Typ	Max	Units
Gain	G_{ps}	12.5	15	—	dB
Drain Efficiency	η_D	20	22	—	%
Intermodulation Distortion	IMD	—	-40	-38	dBc

DC Characteristics at $T_{CASE} = 25^{\circ}C$ unless otherwise indicated

Characteristic	Conditions	Symbol	Min	Typ	Max	Units
Drain–Source Breakdown Voltage	$V_{GS} = 0 V, I_{DS} = 10 \mu A/side$	$V_{(BR)DSS}$	65	—	—	V
Drain Leakage Current	$V_{DS} = 28 V, V_{GS} = 0 V$	I_{DSS}	—	—	1.0	μA
On–State Resistance	$V_{GS} = 10 V, V_{DS} = 0.1 V$	$R_{DS(on)}$	—	0.1	—	Ω
Operating Gate Voltage	$V_{DS} = 28 V, I_{DQ} = 1.0 A/side$	V_{GS}	2.5	3.2	4	V
Gate Leakage Current	$V_{GS} = 10 V, V_{DS} = 0 V$	I_{GSS}	—	—	1.0	μA

Maximum Ratings

Parameter	Symbol	Value	Unit
Drain–Source Voltage	V_{DSS}	65	V
Gate–Source Voltage	V_{GS}	-0.5 to +12	V
Junction Temperature	T_J	200	$^{\circ}C$
Total Device Dissipation Above 25 $^{\circ}C$ derate by	PTF211802A P_D	498 2.85	W W/ $^{\circ}C$
Total Device Dissipation Above 25 $^{\circ}C$ derate by	PTF211802E P_D	647 3.70	W W/ $^{\circ}C$
Storage Temperature Range	T_{STG}	-40 to +150	$^{\circ}C$
Thermal Resistance ($T_{CASE} = 70^{\circ}C, 130 W CW$)	PTF211802A $R_{\theta JC}$	0.35	$^{\circ}C/W$
	PTF211802E $R_{\theta JC}$	0.27	$^{\circ}C/W$

Typical Performance (data taken in a production test fixture)

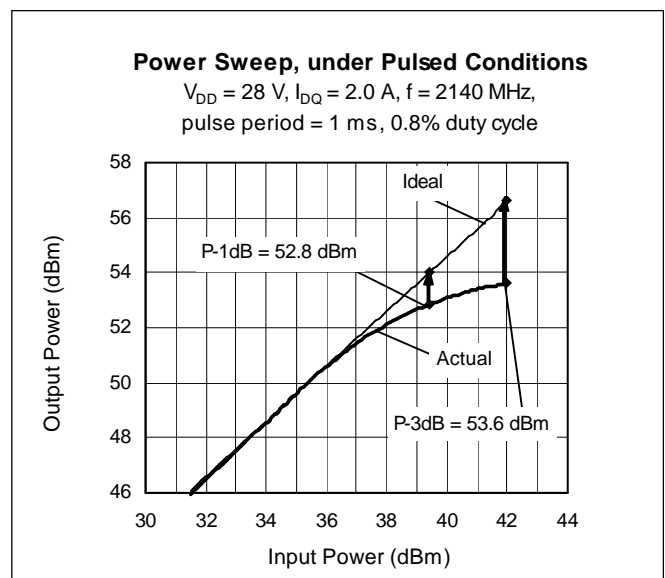
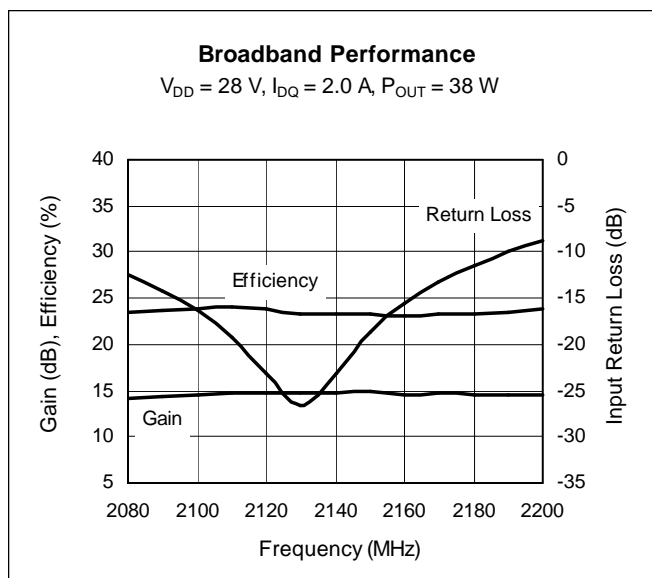

Typical Performance (cont.)

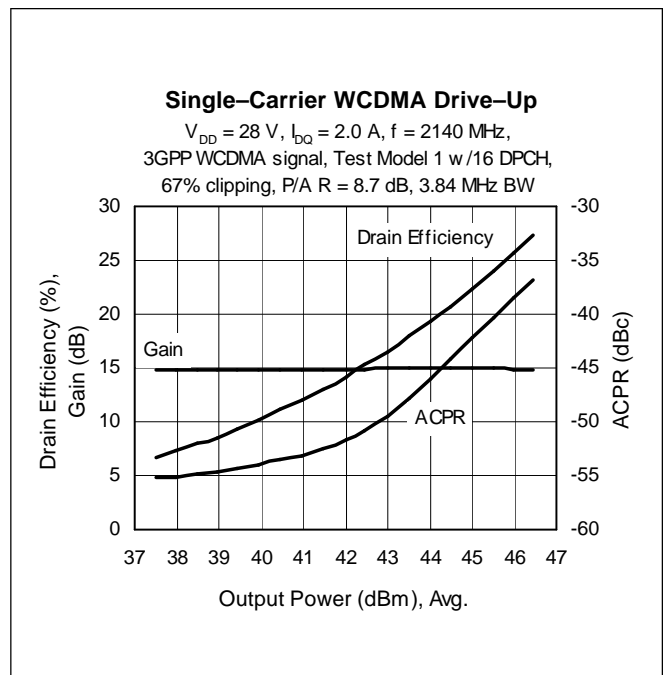
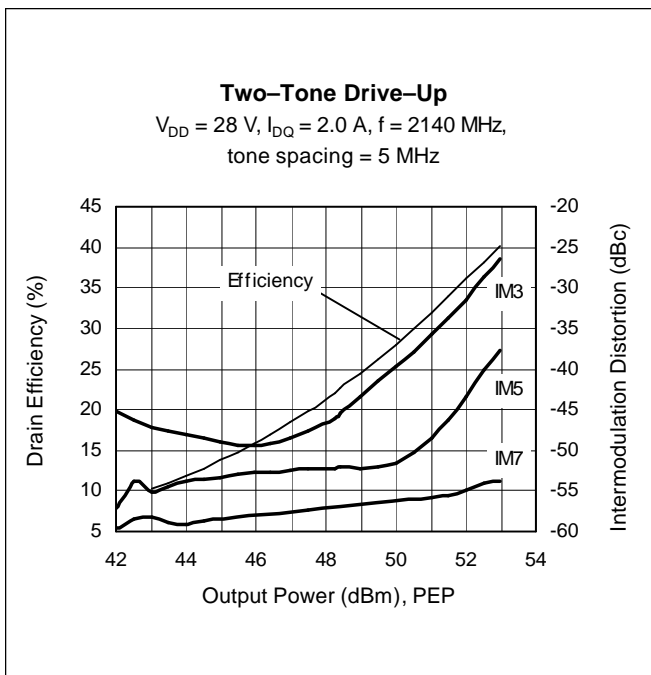
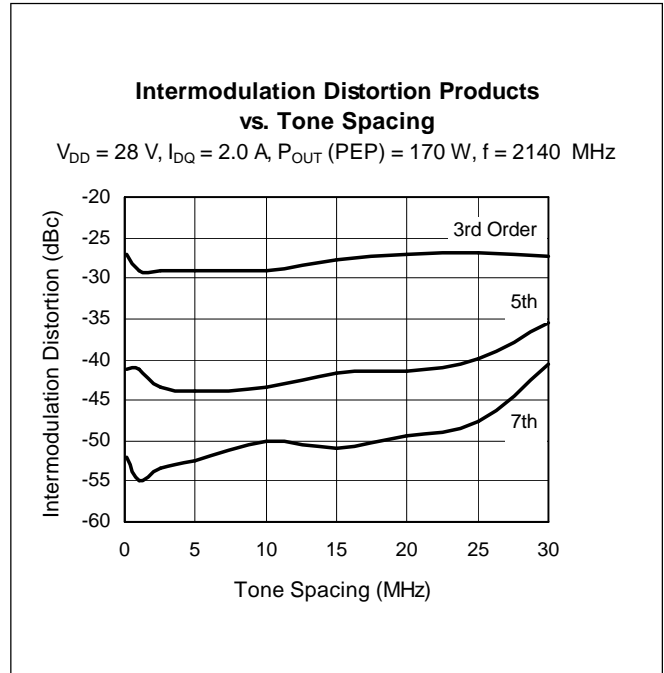
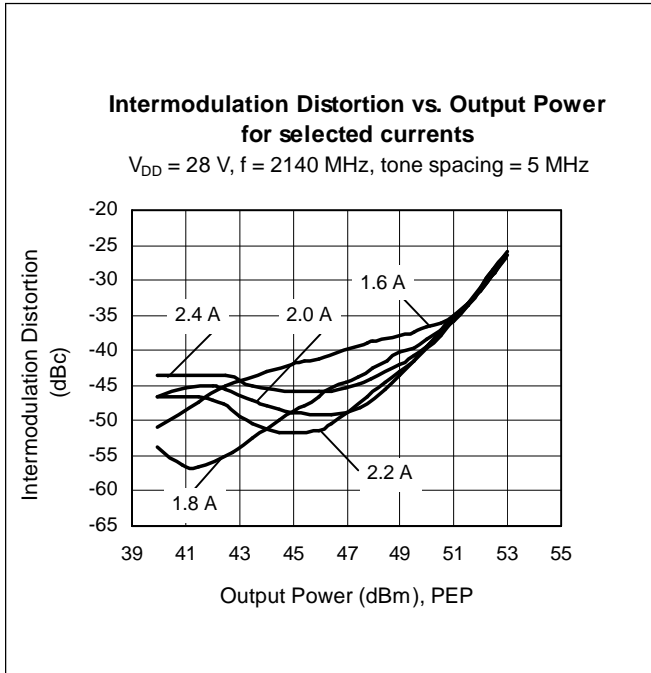

Typical Performance (cont.)

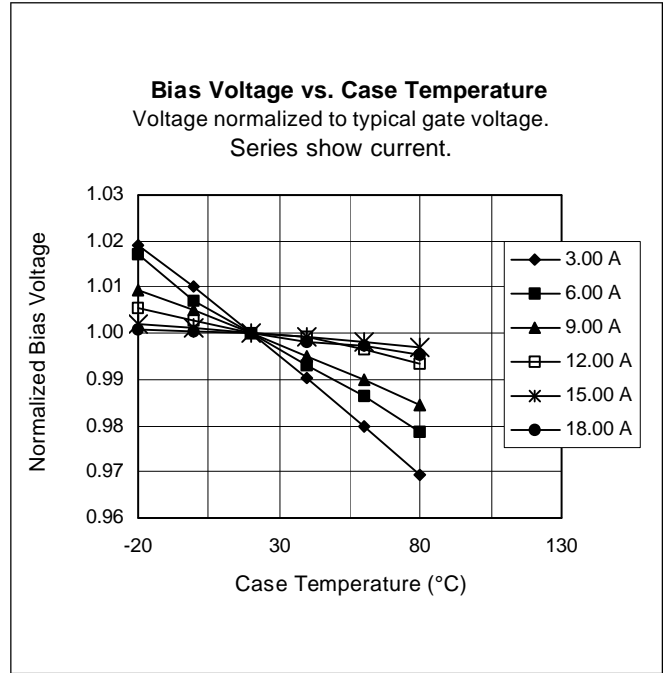
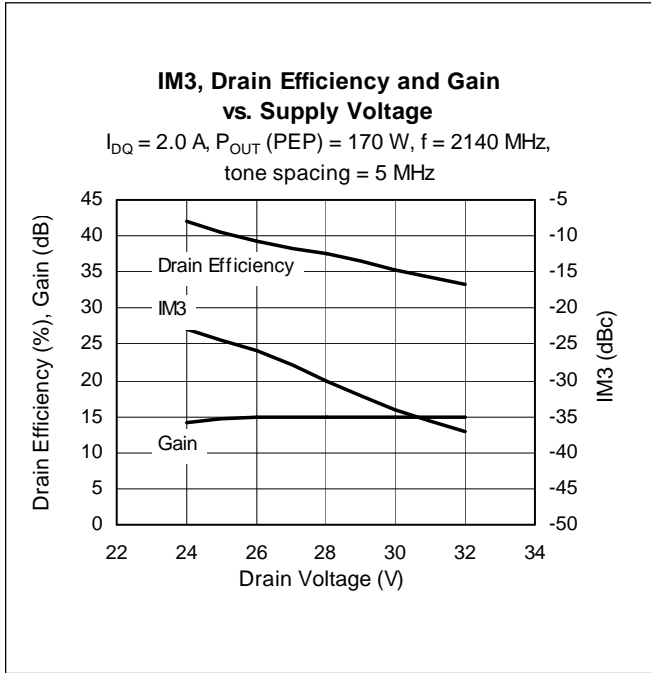

Broadband Circuit Impedance Data

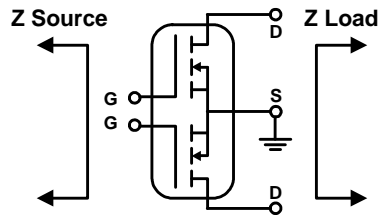

Frequency MHz	Z Source Ω		Z Load Ω	
	R	jX	R	jX
2070	10.22	-14.00	4.28	1.24
2110	9.56	-13.48	4.06	1.94
2140	9.14	-13.00	3.98	2.42
2170	8.70	-12.60	3.84	2.90
2200	8.24	-12.22	3.76	3.34

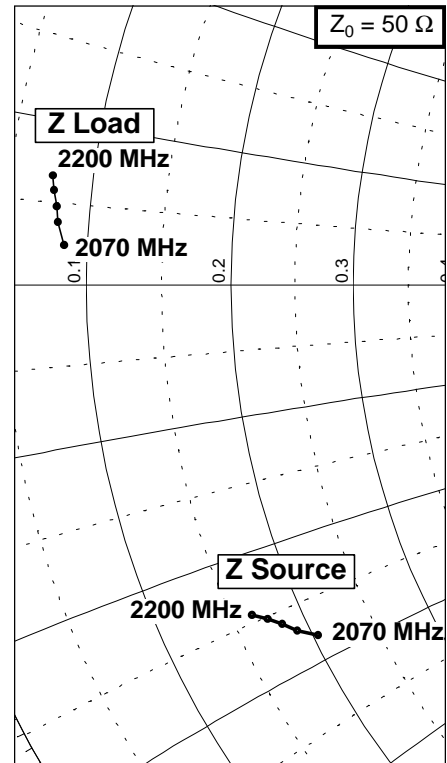

Reference Circuit

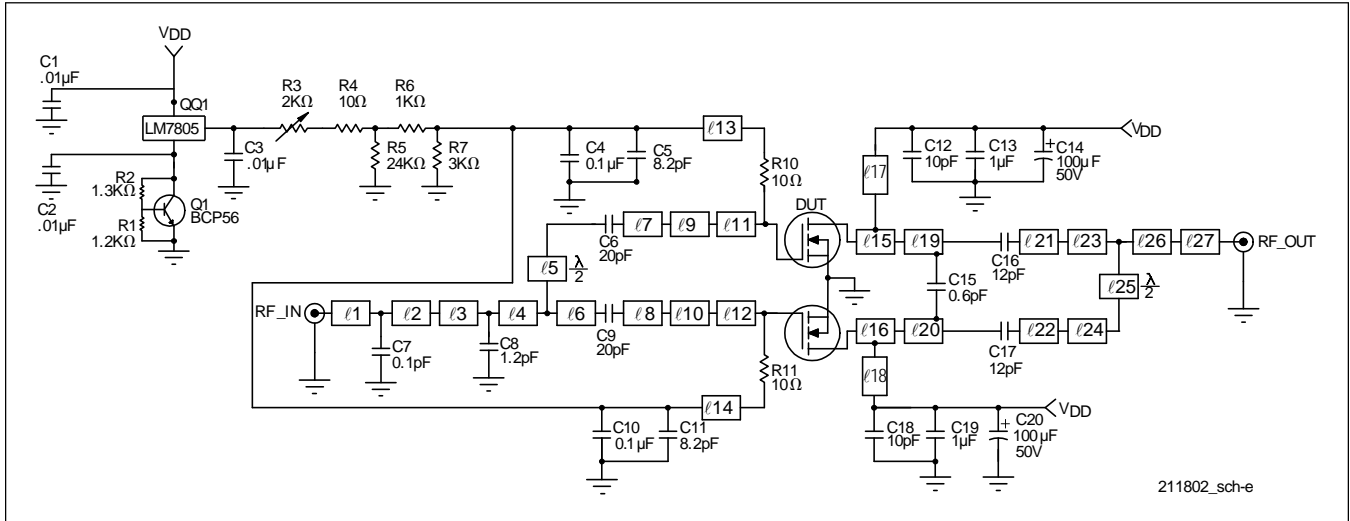

Reference Circuit Schematic for 2140 MHz

Circuit Assembly Information

DUT	PTF211802E	LDMOS transistor	
Circuit board	0.76 mm [.030"] thick, $\epsilon_r = 3.48$	Rogers 4350, 2 oz. copper	

Microstrip	Electrical Characteristics at 2140 MHz	Dimensions: L x W (mm.)	Dimensions: L x W (in.)
l1	0.110 λ , 50.0 Ω	9.40 x 1.70	0.370 x 0.067
l2	0.175 λ , 50.0 Ω	14.78 x 1.70	0.582 x 0.067
l3	0.205 λ , 35.4 Ω	16.99 x 2.84	0.669 x 0.112
l4	0.092 λ , 35.4 Ω	7.57 x 2.84	0.298 x 0.112
l5	0.500 λ , 50.0 Ω	42.67 x 1.70	1.680 x 0.067
l6	0.052 λ , 50.0 Ω	4.39 x 1.70	0.173 x 0.067
l7, l8	0.110 λ , 31.8 Ω	9.04 x 3.30	0.356 x 0.130
l9, l10	0.073 λ , 22.4 Ω	5.84 x 5.26	0.230 x 0.207
l11, l12	0.089 λ , 9.10 Ω	6.86 x 15.09	0.270 x 0.594
l13, l14	0.337 λ , 50.4 Ω	28.58 x 1.70	1.125 x 0.067
l15, l16	0.132 λ , 8.42 Ω	10.01 x 16.33	0.394 x 0.643
l17, l18	0.250 λ , 50.0 Ω	21.26 x 1.70	0.837 x 0.067
l19, l20	0.035 λ , 13.2 Ω	2.74 x 9.96	0.108 x 0.392
l21, l22	0.057 λ , 36.5 Ω	4.70 x 2.72	0.185 x 0.107
l23, l24	0.061 λ , 50.0 Ω	5.21 x 1.70	0.205 x 0.067
l25	0.500 λ , 50.0 Ω	42.67 x 1.70	1.680 x 0.067
l26	0.264 λ , 35.4 Ω	21.79 x 2.84	0.858 x 0.112
l27	0.136 λ , 50.0 Ω	11.51 x 1.70	0.453 x 0.067

Reference Circuit (cont.)

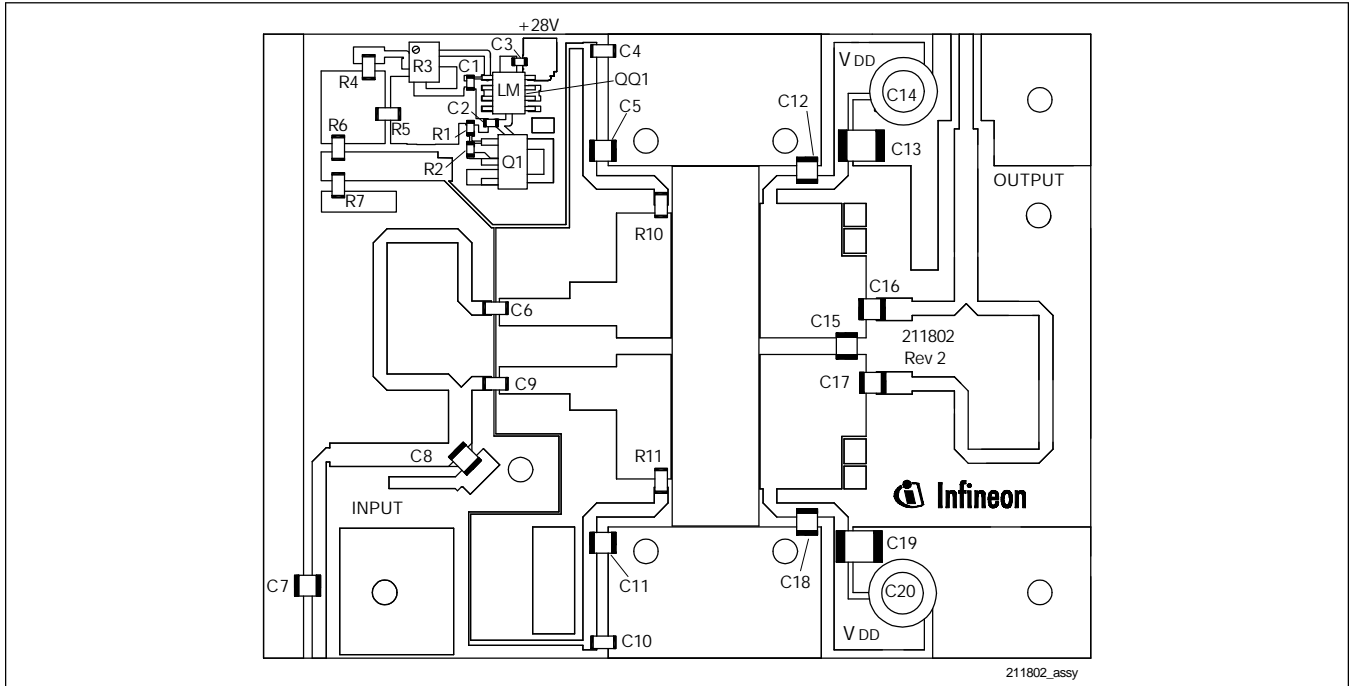

Reference Circuit¹ (not to scale)

Component	Description	Manufacturer	P/N or Comment
C1, C2, C3	Capacitor, 0.01 μ F 50 V	Digi-Key	PCC1772CT-ND
C4, C10	Capacitor, 0.1 μ F, 50 V	Digi-Key	PCC104BCT-ND
C5, C11	Capacitor, 8.2 pF	ATC	100 B 8R2
C6, C9	Capacitor, 20 pF	ATC	100 A 200
C7	Capacitor, 0.1 pF	ATC	100 B 0R1
C8	Capacitor, 1.2 pF	ATC	100 B 1R2
C12, C18	Capacitor, 10 pF	ATC	100 B 100
C13, C19	Capacitor, 1 μ F, ceramic, 50 V	ATC	920DC105KW100
C14, C20	Capacitor, 100 μ F, 50 V, electrolytic	Digi-Key	P5182-ND
C15	Capacitor, 0.6 pF	ATC	100 B 0R6
C16, C17	Capacitor, 12 pF	ATC	100 B 120
QQ1	Voltage Regulator	Digi-Key	LM 7805
Q1	Transistor	Infineon	BCP56
R1	Resistor, 1.2 k Ω , 1/10 W, 0603	Digi-Key	P1.2KGCT-ND
R2	Resistor, 1.3 k Ω , 1/10 W, 0603	Digi-Key	P1.3KGCT-ND
R3	Resistor, variable 2 k Ω , 4 W, 1206	Digi-Key	3224W-202ETR-ND
R4, R10, R11	Resistor, 10 Ω , 1/4 W, 1206	Digi-Key	P10KECT-ND
R5	Resistor, 24 k Ω , 1/4 W, 1206	Digi-Key	P24KECT-ND
R6	Resistor, 1 k Ω , 1/4 W, 1206	Digi-Key	P1.0KECT-ND
R7	Resistor, 3 k Ω , 1/4 W, 1206	Digi-Key	P3.0KECT-ND

¹Gerber Files for this circuit available on request.

Package Outline Specifications

Type	Package Outline	Package Description	Marking
PTF211802A	20275	Standard ceramic, flange	PTF211802A
PTF211802E	30275	Thermally enhanced, flange	PTF211802E

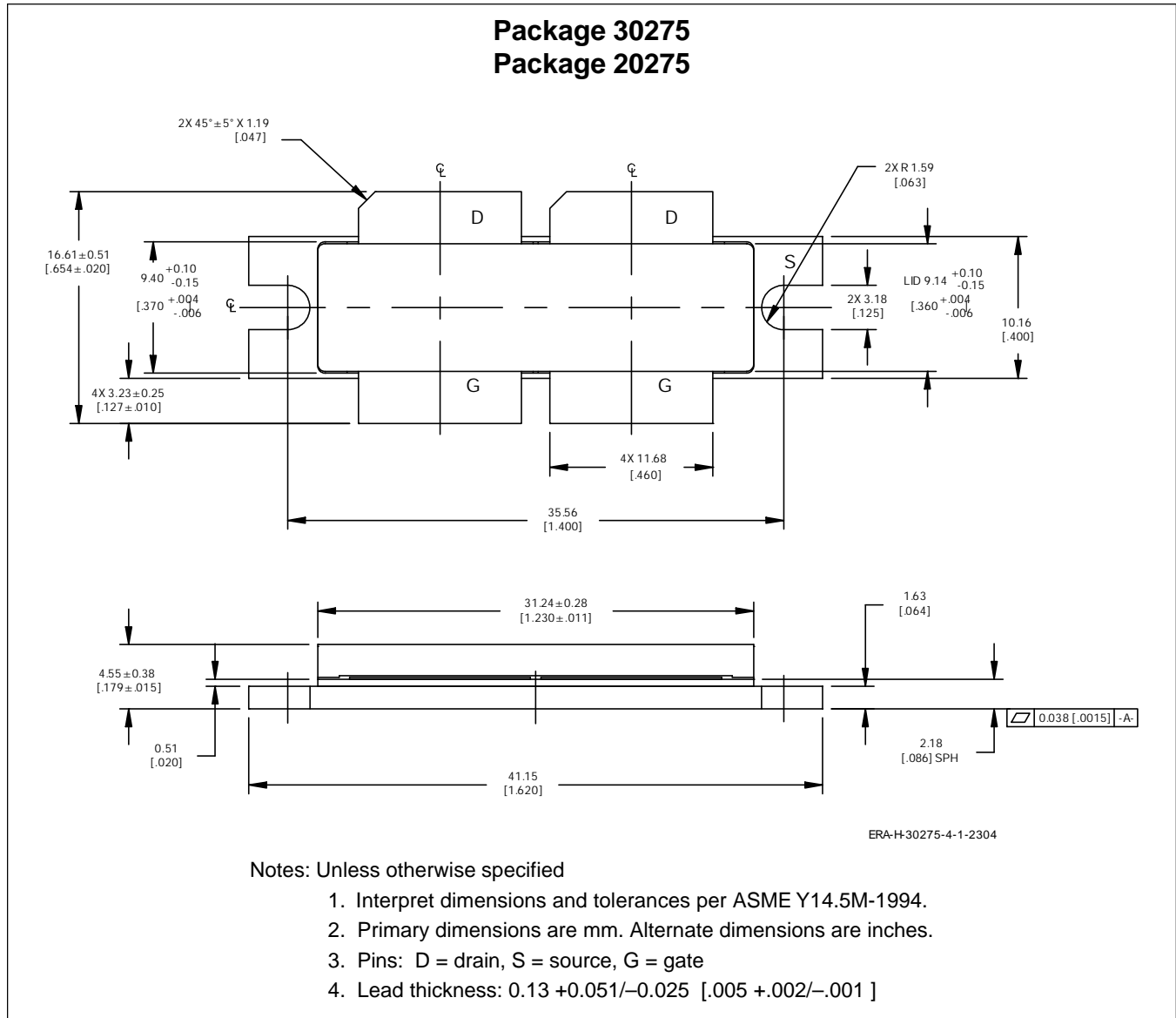

Find the latest and most complete information about products and packaging at the Infineon Internet page <http://www.infineon.com/products>

PTF211802

Revision History: Data Sheet 2004-02-13

Previous Version: Data Sheet, 2004-01-06

Page	Subjects (major changes since last revision)
	Combine PTF211802A and PTF211802E onto this Data Sheet.
5, 6	Alter circuit configuration

We Listen to Your Comments

Any information within this document that you feel is wrong, unclear or missing at all?
Your feedback will help us to continuously improve the quality of this document.
Please send your proposal (including a reference to this document) to:

highpowerRF@infineon.com

To request other information, contact us at:
+1 877 465 3667 (1-877-GOLDMOS) USA
or +1 408 776 0600 International

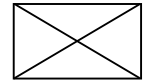

GOLDMOS® is a registered trademark of Infineon Technologies AG.

Edition 2004-02-13

**Published by Infineon Technologies AG,
St.-Martin-Strasse 53,
81669 München, Germany**

**© Infineon Technologies AG 2004.
All Rights Reserved.**

Attention please!

The information herein is given to describe certain components and shall not be considered as a guarantee of characteristics.
Terms of delivery and rights to technical change reserved.

We hereby disclaim any and all warranties, including but not limited to warranties of non-infringement, regarding circuits, descriptions and charts stated herein.

Information

For further information on technology, delivery terms and conditions and prices please contact your nearest Infineon Technologies Office (www.infineon.com/rfpower).

Warnings

Due to technical requirements components may contain dangerous substances. For information on the types in question please contact your nearest Infineon Technologies Office.

Infineon Technologies Components may only be used in life-support devices or systems with the express written approval of Infineon Technologies, if a failure of such components can reasonably be expected to cause the failure of that life-support device or system, or to affect the safety or effectiveness of that device or system. Life support devices or systems are intended to be implanted in the human body, or to support and/or maintain and sustain and/or protect human life. If they fail, it is reasonable to assume that the health of the user or other persons may be endangered.