

## Thermally-Enhanced High Power RF LDMOS FET 300 W, 470 – 860 MHz

### Description

The PTFA043002 is a 300-watt, internally-matched, laterally-diffused, GOLDMOS® push-pull FET intended for analog and digital broadcast, including 8VSB and COFDM applications from 470 to 860 MHz. The thermally-enhanced package provides the coolest operation available. Full gold metallization ensures excellent device lifetime and reliability.



PTFA043002E  
Package H-30275-4

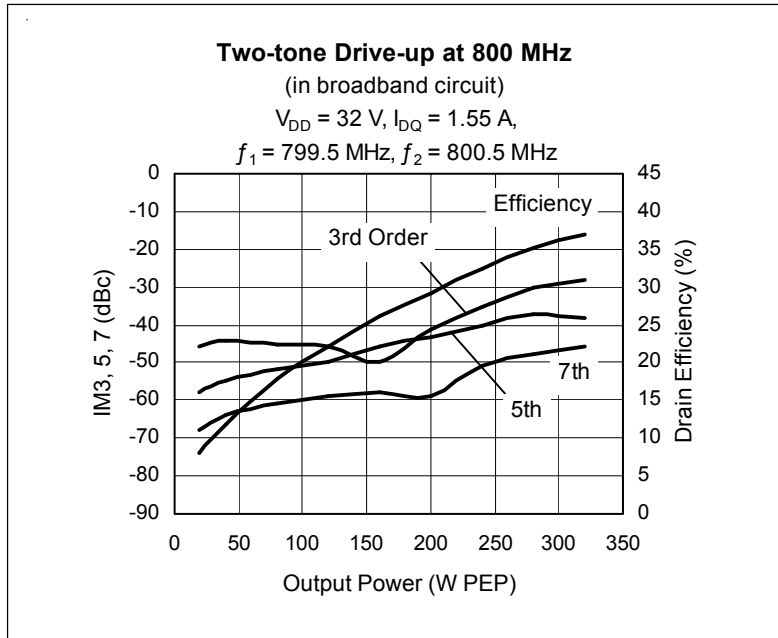

### Features

- Thermally-enhanced package
- Broadband internal matching
- Typical 8VSB performance
  - Average output power = 100 W
  - Gain = 16 dB
  - Adjacent < -33 dBc
- Integrated ESD protection: Human Body Model, Class 2 (minimum)
- Excellent thermal stability
- Low HCI drift
- Pb-free and RoHS compliant
- Capable of handling 5:1 VSWR at 32 V, 300 W (CW) output power

### RF Characteristics

#### ATSC 8VSB Characteristics (broadband fixture, push-pull configuration)

( $V_{DD} = 32\text{ V}$ ,  $P_{OUT} = 100\text{ W}_{AVG}$ ,  $I_{DQ} = 1.55\text{ A}$ ,  $f = 800\text{ MHz}$ )

Characteristic	Symbol	Min	Typ	Max	Unit
Common Source Power Gain	$G_{ps}$	—	16	—	dB
Drain Efficiency	$\eta_D$	—	28	—	%
Flrst Adjacent	IMD	—	-33	—	dBc

All published data at  $T_{CASE} = 25^\circ\text{C}$  unless otherwise indicated

**ESD:** Electrostatic discharge sensitive device—observe handling precautions!

**RF Characteristics** (cont.)

**Two-tone Measurements** (tested in narrowband test fixture)

 $V_{DD} = 32\text{ V}$ ,  $I_{DQ} = 1.55\text{ A}$ ,  $P_{OUT} = 300\text{ W}_{PEP}$ ,  $f = 860\text{ MHz}$ , tone spacing = 1 MHz

Characteristic	Symbol	Min	Typ	Max	Unit
Gain	$G_{ps}$	16	17.5	—	dB
Drain Efficiency	$\eta_D$	38	41	—	%
Intermodulation Distortion	IMD	—	-29	-28	dBc

**DC Characteristics** (one side)

Characteristic	Conditions	Symbol	Min	Typ	Max	Unit
Drain-Source Breakdown Voltage	$V_{GS} = 0\text{ V}$ , $I_{DS} = 10\text{ mA/side}$	$V_{(BR)DSS}$	65	—	—	V
Drain Leakage Current	$V_{DS} = 28\text{ V}$ , $V_{GS} = 0\text{ V}$	$I_{DSS}$	—	—	1.0	$\mu\text{A}$
	$V_{DS} = 63\text{ V}$ , $V_{GS} = 0\text{ V}$	$I_{DSS}$	—	—	10.0	$\mu\text{A}$
On-State Resistance	$V_{GS} = 10\text{ V}$ , $V_{DS} = 0.1\text{ V}$	$R_{DS(on)}$	—	0.08	—	$\text{W}$
Operating Gate Voltage	$V_{DS} = 28\text{ V}$ , $I_{DQ} = 0.75\text{ A/side}$	$V_{GS}$	2.0	2.5	3.0	V
Gate Leakage Current	$V_{GS} = 10\text{ V}$ , $V_{DS} = 0\text{ V}$	$I_{GSS}$	—	—	1.0	$\mu\text{A}$

**Maximum Ratings**

Parameter	Symbol	Value	Unit
Drain-Source Voltage	$V_{DSS}$	65	V
Gate-Source Voltage	$V_{GS}$	-0.5 to +12	V
Junction Temperature	$T_J$	200	$^{\circ}\text{C}$
Total Device Dissipation	$P_D$	761	W
		Above 25 $^{\circ}\text{C}$ derate by	4.35
Storage Temperature Range	$T_{STG}$	-40 to +150	$^{\circ}\text{C}$
Thermal Resistance ( $T_{CASE} = 70^{\circ}\text{C}$ , 300 W CW)	$R_{\theta JC}$	0.23	$^{\circ}\text{C/W}$

**Ordering Information**

Type	Package Outline	Package Description	Marking
PTFA043002E	H-30275-4	Thermally-enhanced, flange mount	PTFA043002E

**Typical Performance** (data taken in a broadband test fixture)

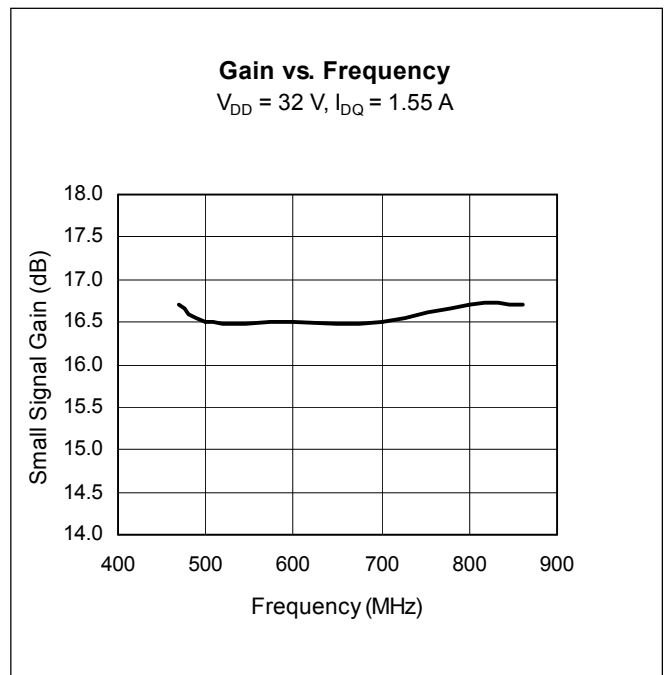
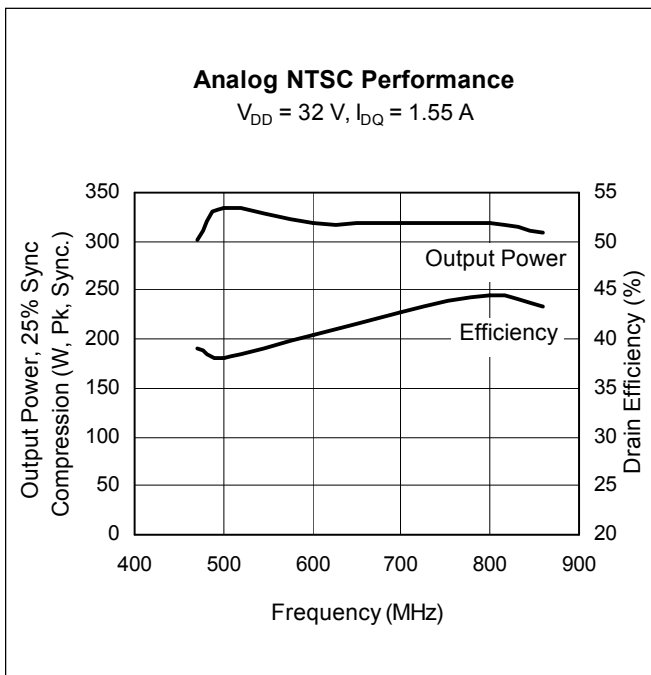
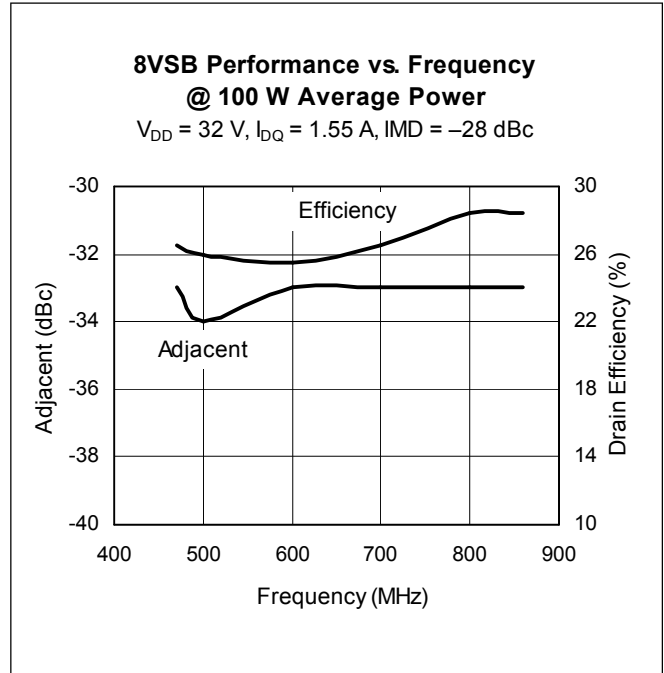
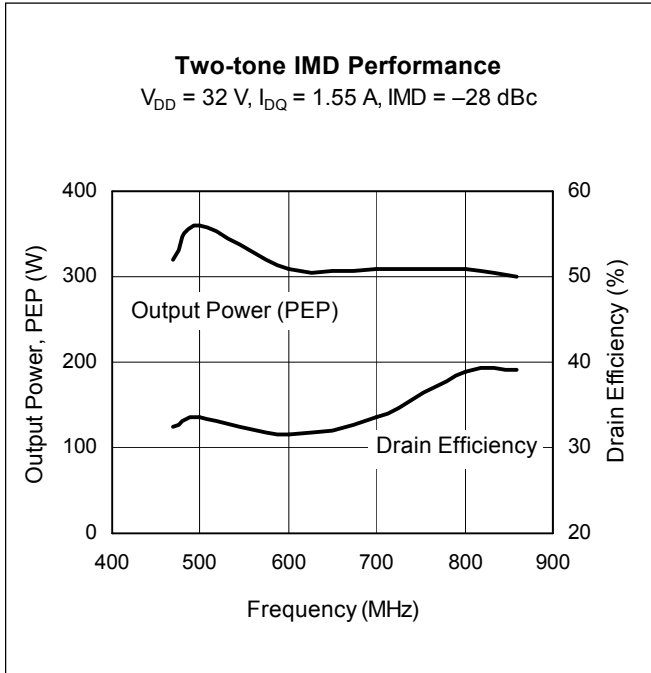

Typical Performance (cont.)

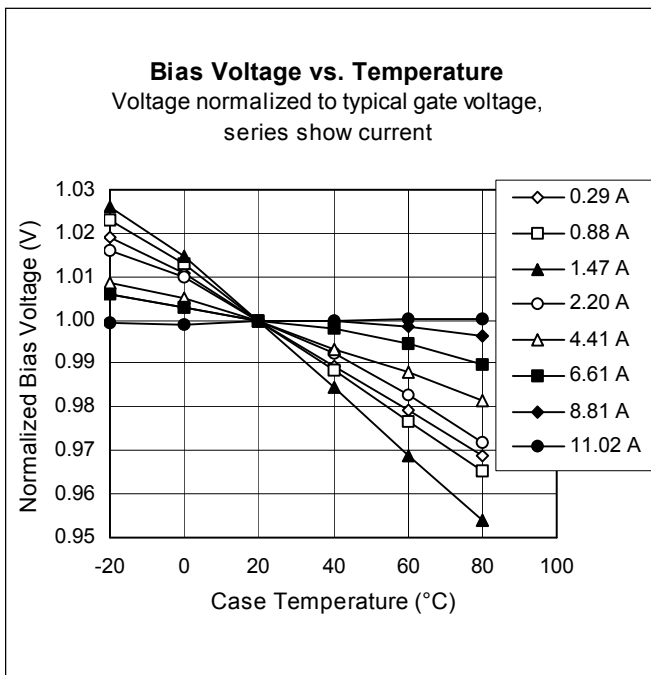
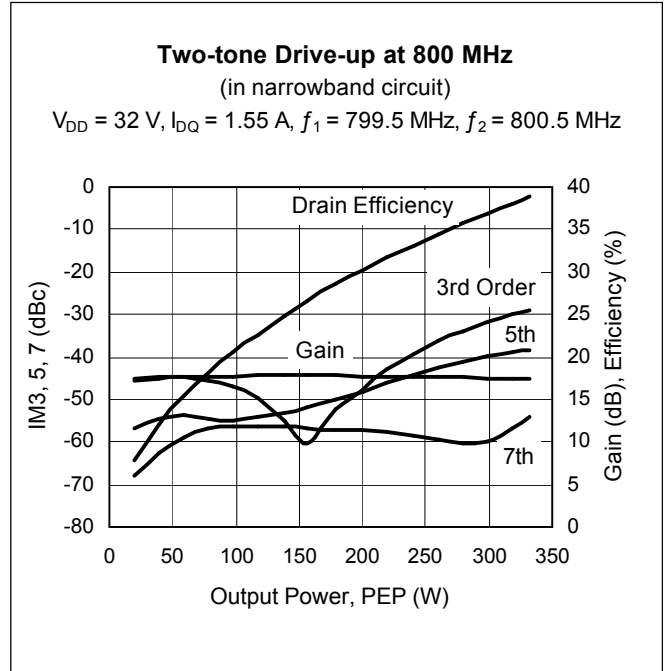
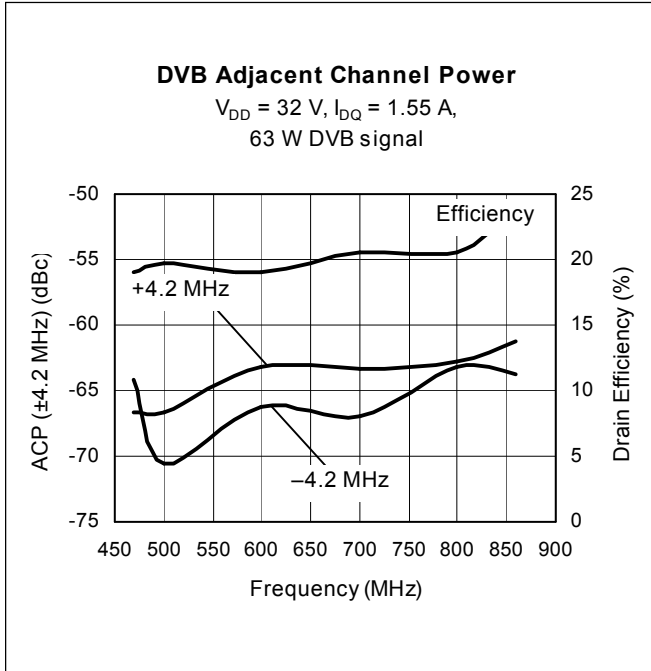

**Broadband Circuit Impedance Data**

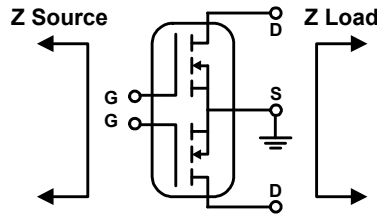

Frequency MHz	Z Source W		Z Load W	
	R	jX	R	jX
450	3.00	-4.61	1.78	-3.26
475	3.02	-3.71	1.85	-2.63
500	3.18	-2.96	1.99	-2.09
525	3.43	-2.36	2.18	-1.64
550	3.75	-1.90	2.41	-1.28
575	4.10	-1.61	2.64	-1.03
600	4.42	-1.47	2.85	-0.87
625	4.66	-1.44	3.01	-0.77
650	4.79	-1.47	3.10	-0.70
675	4.84	-1.50	3.15	-0.63
700	4.84	-1.50	3.17	-0.53
725	4.82	-1.46	3.20	-0.42
750	4.82	-1.42	3.24	-0.31
775	4.83	-1.41	3.30	-0.22
800	4.80	-1.46	3.33	-0.18
825	4.69	-1.54	3.30	-0.16
850	4.43	-1.61	3.17	-0.13
875	4.04	-1.54	2.95	-0.01
900	3.57	-1.27	2.67	0.27

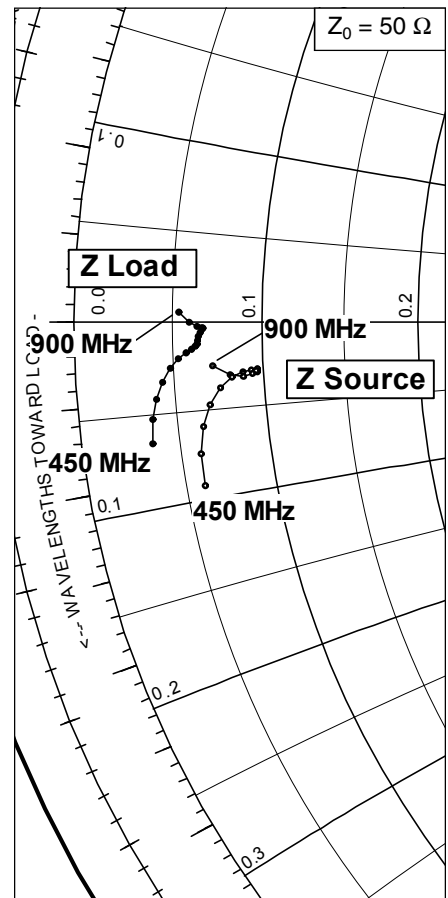

Reference Circuit

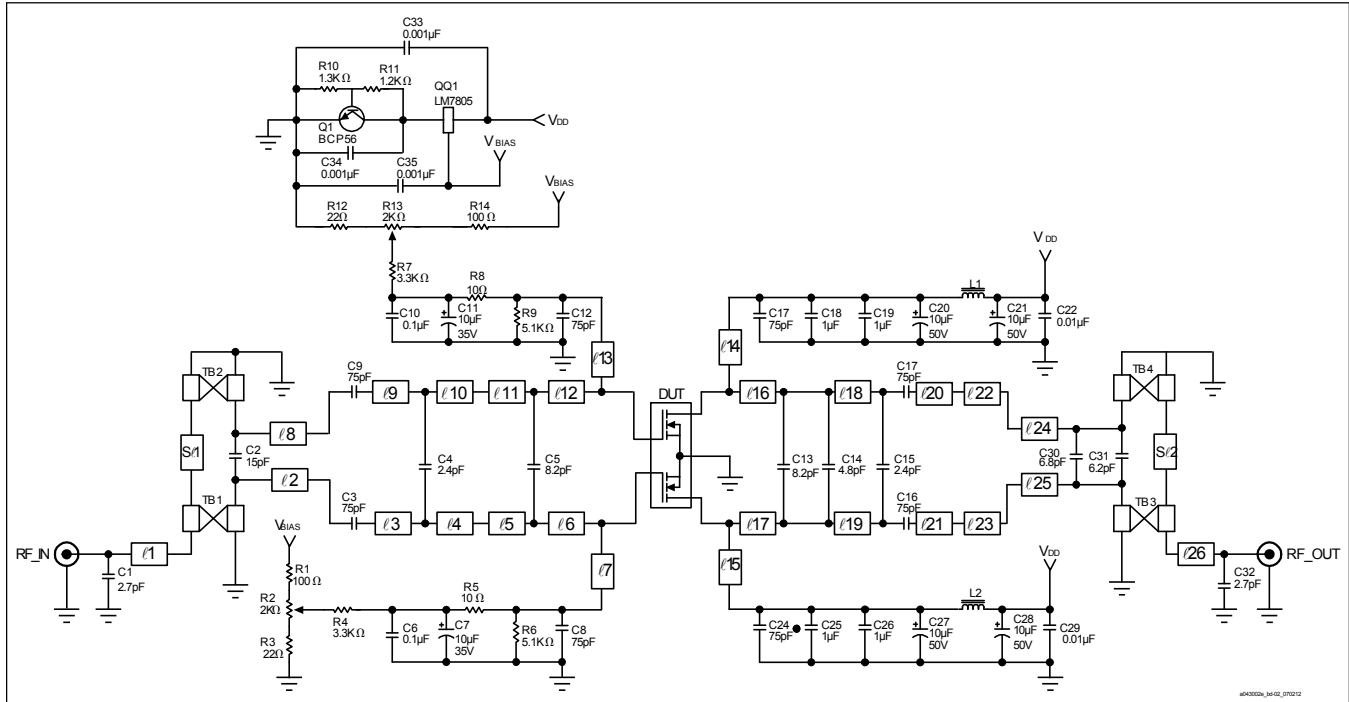

Reference circuit schematic for 470 to 860 MHz—rated for 300 W (PEP) only

Circuit Assembly Information

DUT	PTFA043002E	LDMOS transistor
Circuit board	0.25 mm [.010"] over .635 mm [.025"] thick, $\epsilon_r = 10.2$ copper: 10 mils top 25 mils bottom	Rogers 3010, multilayer

Microstrip	Electrical Characteristics at 860 MHz <sup>1</sup>	Dimensions: L x W (mm)	Dimensions: L x W (in.)
TB1, TB2, TB3, TB4	Broadside coupled striplines	14.63 x 1.70	0.576 x 0.067
S1, S2	0.017 $\lambda$ , 15.6 $\Omega$	33.02 x 1.32	0.075 x 0.067
l1, l26	0.250 $\lambda$ , 39.0 $\Omega$	0.51 x 2.54	1.300 x 0.052
l2, l8, l24, l25	0.004 $\lambda$ , 26.0 $\Omega$	5.59 x 15.24	0.020 x 0.100
l3, l9	0.049 $\lambda$ , 6.1 $\Omega$	4.45 x 15.24	0.220 x 0.600
l4, l10	0.038 $\lambda$ , 6.1 $\Omega$	7.62 x 22.86	0.175 x 0.600
l5, l11	0.067 $\lambda$ , 4.2 $\Omega$	6.25 x 25.40	0.300 x 0.900
l6, l12	0.055 $\lambda$ , 3.8 $\Omega$	28.45 x 1.22	0.246 x 1.000
l7, l13	0.216 $\lambda$ , 41.0 $\Omega$	40.39 x 1.22	1.120 x 0.048
l14, l15	0.307 $\lambda$ , 41.0 $\Omega$	5.08 x 25.40	1.590 x 0.048
l16, l17	0.045 $\lambda$ , 3.8 $\Omega$	12.70 x 25.40	0.200 x 1.000
l18, l19	0.112 $\lambda$ , 3.8 $\Omega$	2.74 x 25.40	0.500 x 1.000
l20, l21	0.024 $\lambda$ , 3.8 $\Omega$	2.54 x 20.32	0.108 x 1.000
l22, l23	0.022 $\lambda$ , 4.7 $\Omega$	2.54 x 20.32	0.100 x 0.800

<sup>1</sup>Electrical characteristics are rounded.

Reference Circuit (cont.)

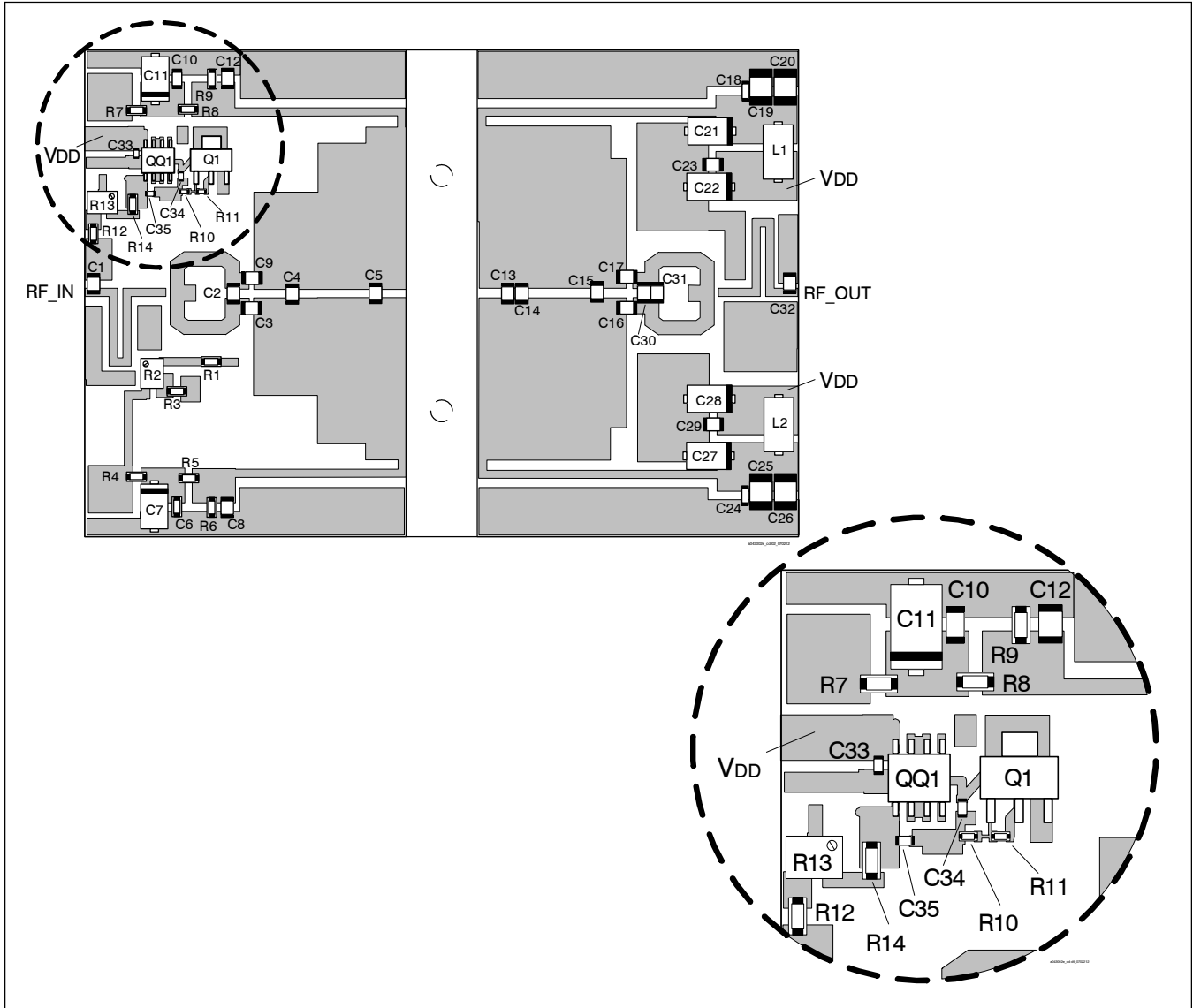

Reference circuit assembly diagram\* (not to scale)—rated for 300 W (PEP) only

\*Gerber Files for this circuit available on request.

**Reference Circuit** (cont.)

Component	Description	Suggested Manufacturer	P/N or Comment
C1, C32	Ceramic capacitor, 2.7 pF	ATC	100B 2R7
C2	Capacitor, 15 pF	ATC	100B 150
C3, C8, C9, C12, C16, C17, C18, C24	Ceramic capacitor, 75 pF	ATC	100B 750
C4, C15	Ceramic capacitor, 2.4 pF	ATC	100B 2R4
C5, C13	Ceramic capacitor, 8.2 pF	ATC	100B 8R2
C6, C10	Capacitor, 0.1 $\mu$ F	Digi-Key	PCC104BCT-ND
C7, C11	Tantalum capacitor, 10 $\mu$ F, 35 V	Digi-Key	PCS6106TR-ND
C14	Ceramic capacitor, 4.8 pF	ATC	100B 4R8
C19, C20, C25, C26	Capacitor, 1 $\mu$ F	ATC	920C105
C21, C22, C27, C28	Tantalum capacitor, 10 $\mu$ F, 50 V	Garrett Electronics	TPS106K050R0400
C23, C29	Ceramic capacitor, 0.01 $\mu$ F	ATC	200B 103
C30	Ceramic capacitor, 6.8 pF	ATC	100B 6R8
C31	Ceramic capacitor, 6.2 pF	ATC	100B 6R2
C33, C34, C35	Capacitor, 0.001 $\mu$ F	Digi-Key	PCC1772CT-ND
L1, L2	Ferrite, 8.9 mm	Elna Magnetics	BDS 4.6/3/8.9-4S2
Q1	Transistor	Infineon Technologies	BCP56
QQ1	Voltage regulator	National Semiconductor	LM7805
R1, R14	Chip Resistor 100 ohms	Digi-Key	P100ECT-ND
R2, R13	Potentiometer 2 k-ohms	Digi-Key	3224W-202ETR-ND
R3, R12	Chip Resistor 22 ohms	Digi-Key	P22KECT-ND
R4, R7	Chip Resistor 3.3 k-ohms	Digi-Key	P3.3KECT-ND
R5, R8	Chip Resistor 10 ohms	Digi-Key	P10ECT-ND
R6, R9	Chip Resistor 5.1 k-ohms	Digi-Key	P5.1KECT-ND
R10	Chip Resistor 1.0 k-ohms	Digi-Key	P1KGCT-ND
R11	Chip Resistor 1.1 k-ohms	Digi-Key	P1.1KGCT-ND

**See next page for package information**



### Package Outline Specifications

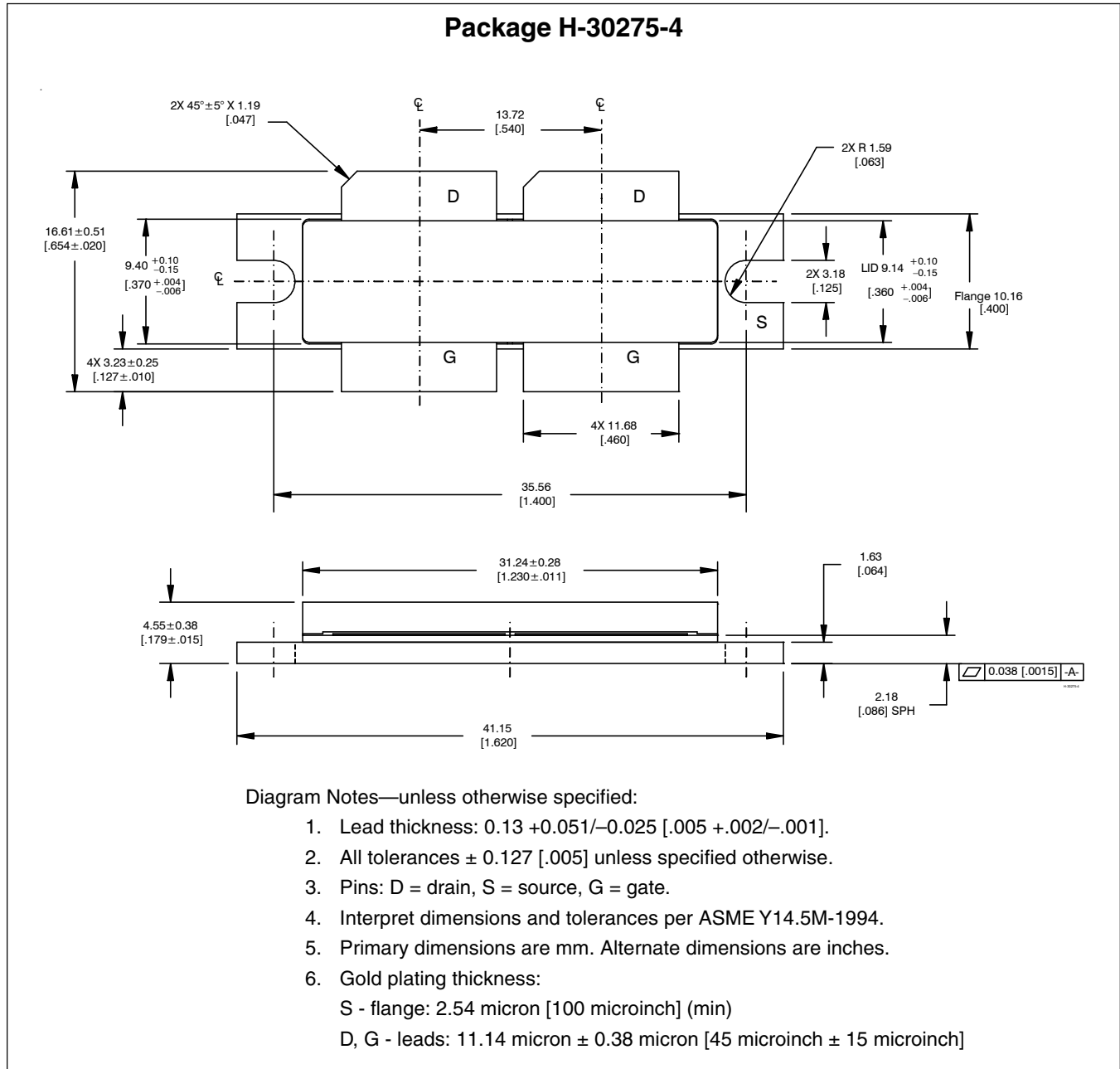

Find the latest and most complete information about products and packaging at the Infineon Internet page <http://www.infineon.com/products>

Revision History: 2009-02-20

Data Sheet

Previous Version: 2005-11-18, Data Sheet

Page	Subjects (major changes since last revision)
6	Revise circuit board information.
1, 2, 9	Update package designation.
8	Fixed typing error

**We Listen to Your Comments**

Any information within this document that you feel is wrong, unclear or missing at all?  
 Your feedback will help us to continuously improve the quality of this document.  
 Please send your proposal (including a reference to this document) to:

[highpowerRF@infineon.com](mailto:highpowerRF@infineon.com)

To request other information, contact us at:  
 +1 877 465 3667 (1-877-GO-LDMOS) USA  
 or +1 408 776 0600 International

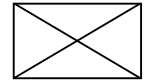
**Edition 2009-02-20****Published by**

**Infineon Technologies AG**  
**81726 Munich, Germany**

**© 2009 Infineon Technologies AG**  
**All Rights Reserved.**

**Legal Disclaimer**

The information given in this document shall in no event be regarded as a guarantee of conditions or characteristics. With respect to any examples or hints given herein, any typical values stated herein and/or any information regarding the application of the device, Infineon Technologies hereby disclaims any and all warranties and liabilities of any kind, including without limitation, warranties of non-infringement of intellectual property rights of any third party.

**Information**

For further information on technology, delivery terms and conditions and prices, please contact the nearest Infineon Technologies Office ([www.infineon.com/rfpower](http://www.infineon.com/rfpower)).

**Warnings**

Due to technical requirements, components may contain dangerous substances. For information on the types in question, please contact the nearest Infineon Technologies Office.

Infineon Technologies components may be used in life-support devices or systems only with the express written approval of Infineon Technologies, if a failure of such components can reasonably be expected to cause the failure of that life-support device or system or to affect the safety or effectiveness of that device or system. Life support devices or systems are intended to be implanted in the human body or to support and/or maintain and sustain and/or protect human life. If they fail, it is reasonable to assume that the health of the user or other persons may be endangered.