

Thermally-Enhanced High Power RF LDMOS FETs 60 W, 725 – 770 MHz

Description

The PTFA070601E and PTFA070601F are 60-watt LDMOS FETs designed for cellular power amplifier applications in the 725 to 770 MHz band. Features include input matching and thermally-enhanced packages with slotted or earless flanges. Manufactured with Infineon's advanced LDMOS process, these devices provide excellent thermal performance and superior reliability.

PTFA070601E
 Package H-36265-2

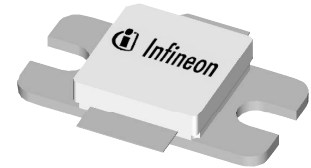

PTFA070601F
 Package H-37265-2

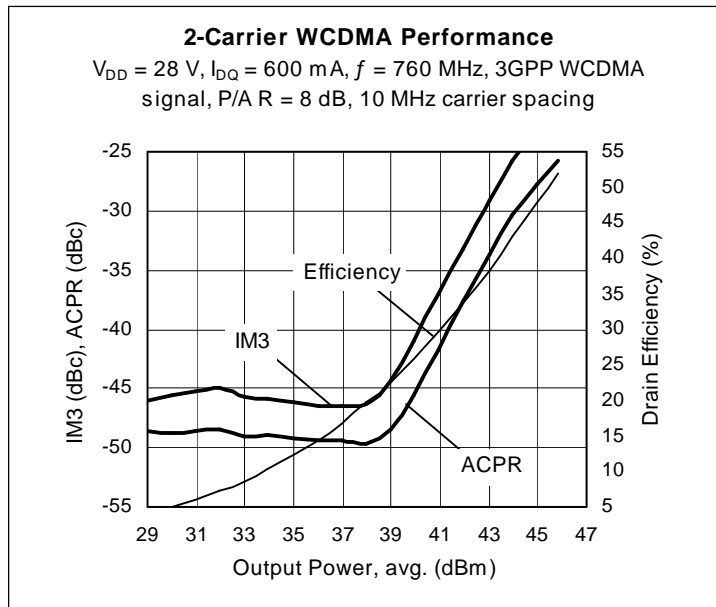

Features

- Broadband internal matching
- Typical WCDMA performance, 760 MHz, 28 V
 - Average output power = 12 W
 - Gain = 19 dB
 - Efficiency = 29%
- Typical CW performance, 760 MHz, 28 V
 - Output power at P-1dB = 60 W
 - Gain = 19 dB
 - Efficiency = 72%
- Integrated ESD protection: Human Body Model, Class 2 (minimum)
- Excellent thermal stability, low HCI drift
- Capable of handling 10:1 VSWR @ 28 V, 60 W (CW) output power
- Pb-free and RoHS-compliant

RF Characteristics

WCDMA Measurements (not subject to production test—verified by design/characterization in Infineon test fixture)

$V_{DD} = 28\text{ V}$, $I_{DQ} = 600\text{ mA}$, $P_{OUT} = 12\text{ W AVG}$, $f = 760\text{ MHz}$

Characteristic	Symbol	Min	Typ	Max	Unit
Intermodulation Distortion	IMD	—	-37	—	dBc
Gain	G_{ps}	—	19	—	dB
Drain Efficiency	η_D	—	29	—	%

All published data at $T_{CASE} = 25^\circ\text{C}$ unless otherwise indicated

ESD: Electrostatic discharge sensitive device—observe handling precautions!

RF Characteristics (cont.)

Two-tone Measurements (tested in Infineon test fixture)

 $V_{DD} = 28\text{ V}$, $I_{DQ} = 600\text{ mA}$, $P_{OUT} = 60\text{ W PEP}$, $f = 760\text{ MHz}$, tone spacing = 1 MHz

Characteristic	Symbol	Min	Typ	Max	Unit
Gain	G_{ps}	18	19.5	—	dB
Drain Efficiency	η_D	46.5	48	—	%
Intermodulation Distortion	IMD	—	-31	-29	dBc

DC Characteristics

Characteristic	Conditions	Symbol	Min	Typ	Max	Unit
Drain-Source Breakdown Voltage	$V_{GS} = 0\text{ V}$, $I_{DS} = 10\text{ }\mu\text{A}$	$V_{(BR)DSS}$	65	—	—	V
Drain Leakage Current	$V_{DS} = 28\text{ V}$, $V_{GS} = 0\text{ V}$	I_{DSS}	—	—	1.0	μA
	$V_{DS} = 63\text{ V}$, $V_{GS} = 0\text{ V}$	I_{DSS}	—	—	10.0	μA
On-State Resistance	$V_{GS} = 10\text{ V}$, $V_{DS} = 0.1\text{ V}$	$R_{DS(on)}$	—	0.15	—	Ω
Operating Gate Voltage	$V_{DS} = 28\text{ V}$, $I_{DQ} = 600\text{ mA}$	V_{GS}	2.0	2.3	3.0	V
Gate Leakage Current	$V_{GS} = 10\text{ V}$, $V_{DS} = 0\text{ V}$	I_{GSS}	—	—	1.0	μA

Maximum Ratings

Parameter	Symbol	Value	Unit
Drain-Source Voltage	V_{DSS}	65	V
Gate-Source Voltage	V_{GS}	-0.5 to +12	V
Junction Temperature	T_J	200	$^{\circ}\text{C}$
Total Device Dissipation	P_D	219	W
		Above 25 $^{\circ}\text{C}$ derate by	1.25
Storage Temperature Range	T_{STG}	-40 to +150	$^{\circ}\text{C}$
Thermal Resistance ($T_{CASE} = 70^{\circ}\text{C}$, 60 W CW)	$R_{\theta JC}$	0.8	$^{\circ}\text{C/W}$

Ordering Information

Type and Version	Package Outline	Package Description	Shipping	Marking
PTFA070601E V4	H-36265-2	Thermally-enhanced, slotted flange, single-ended	Tray	PTFA070601E
PTFA070601F V4	H-37265-2	Thermally-enhanced, earless flange, single-ended	Tray	PTFA070601F

Typical Performance (data taken in a production test fixture)

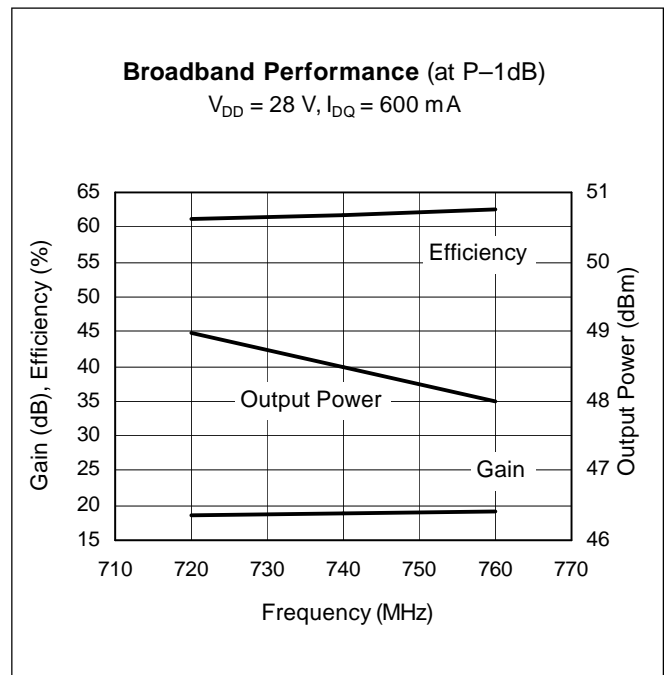
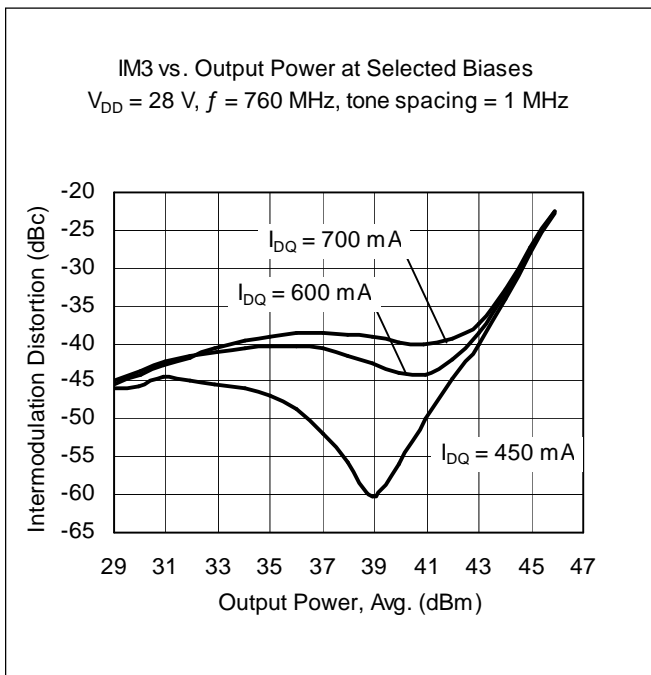
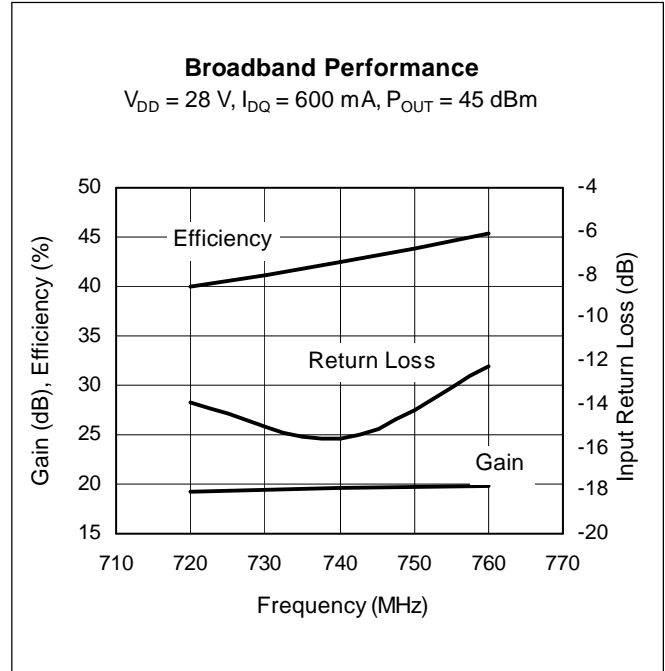
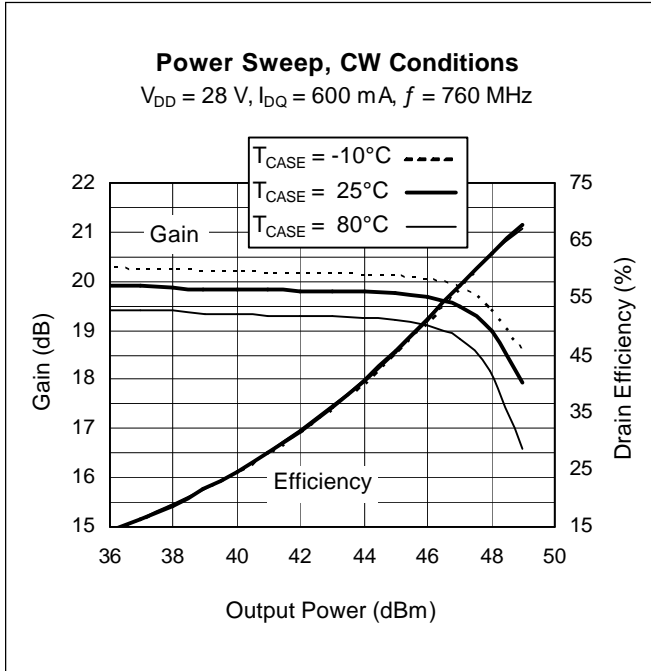

Typical Performance (cont.)

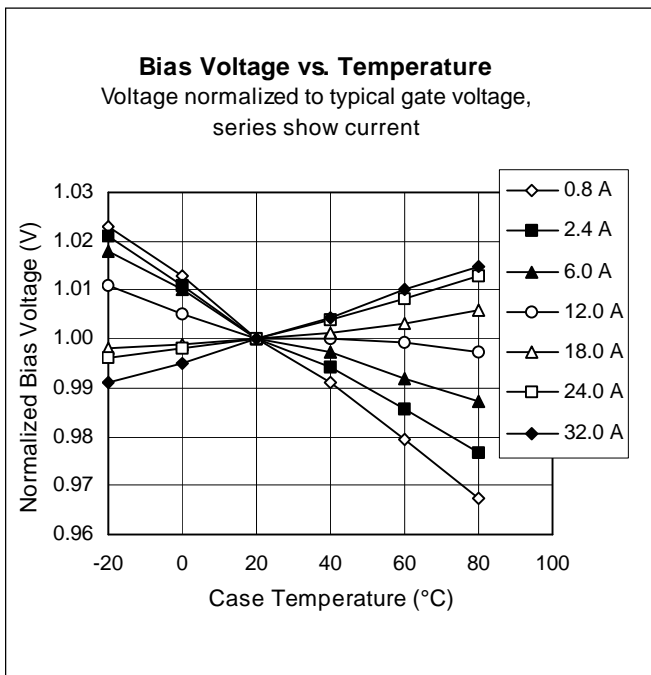
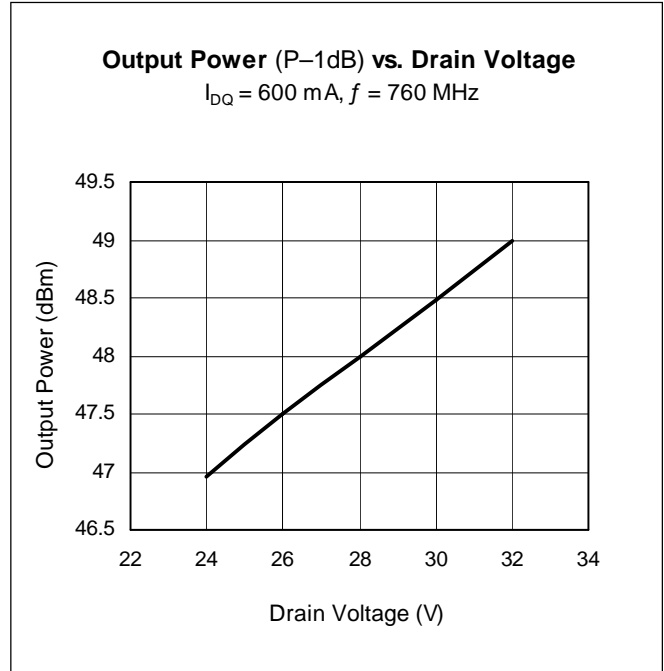
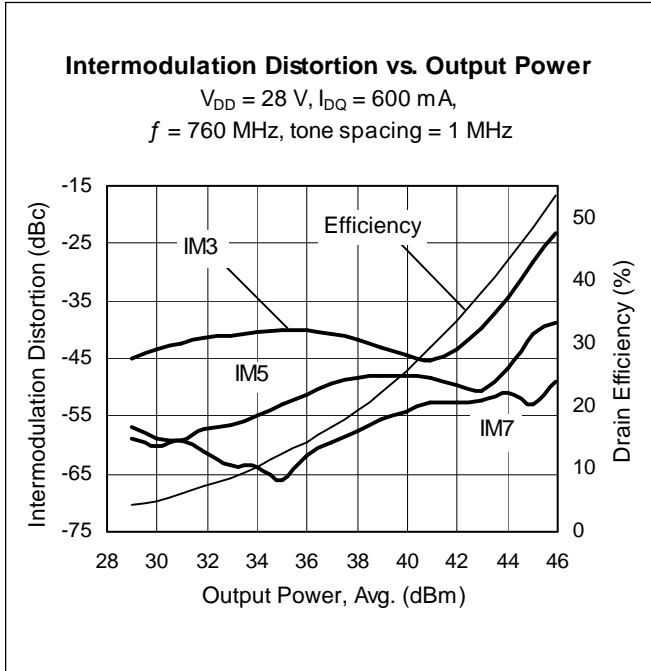

Broadband Circuit Impedance

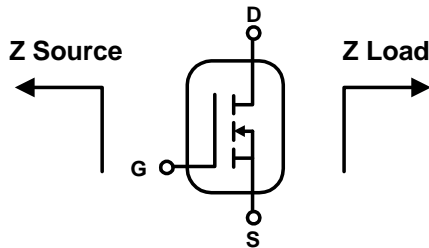

Frequency MHz	Z Source W		Z Load W	
	R	jX	R	jX
700	5.32	-4.82	3.14	0.61
720	5.07	-4.40	3.01	1.02
740	4.84	-3.91	2.88	1.44
760	4.69	-3.40	2.79	1.90
800	4.55	-2.39	2.69	2.82

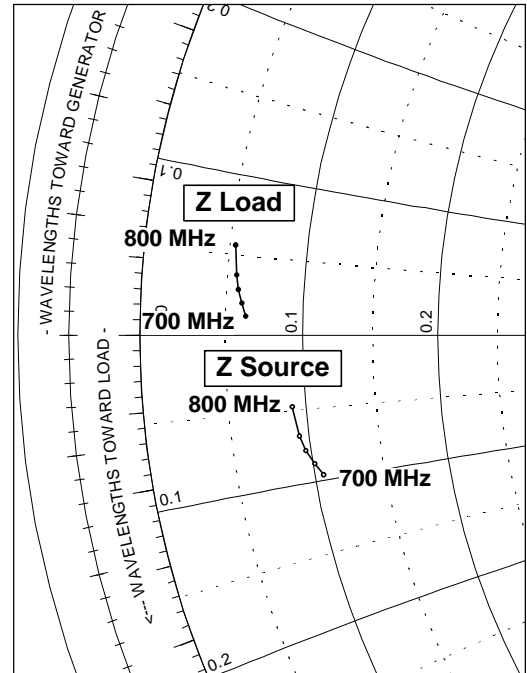

See next page for circuit information

Reference Circuit

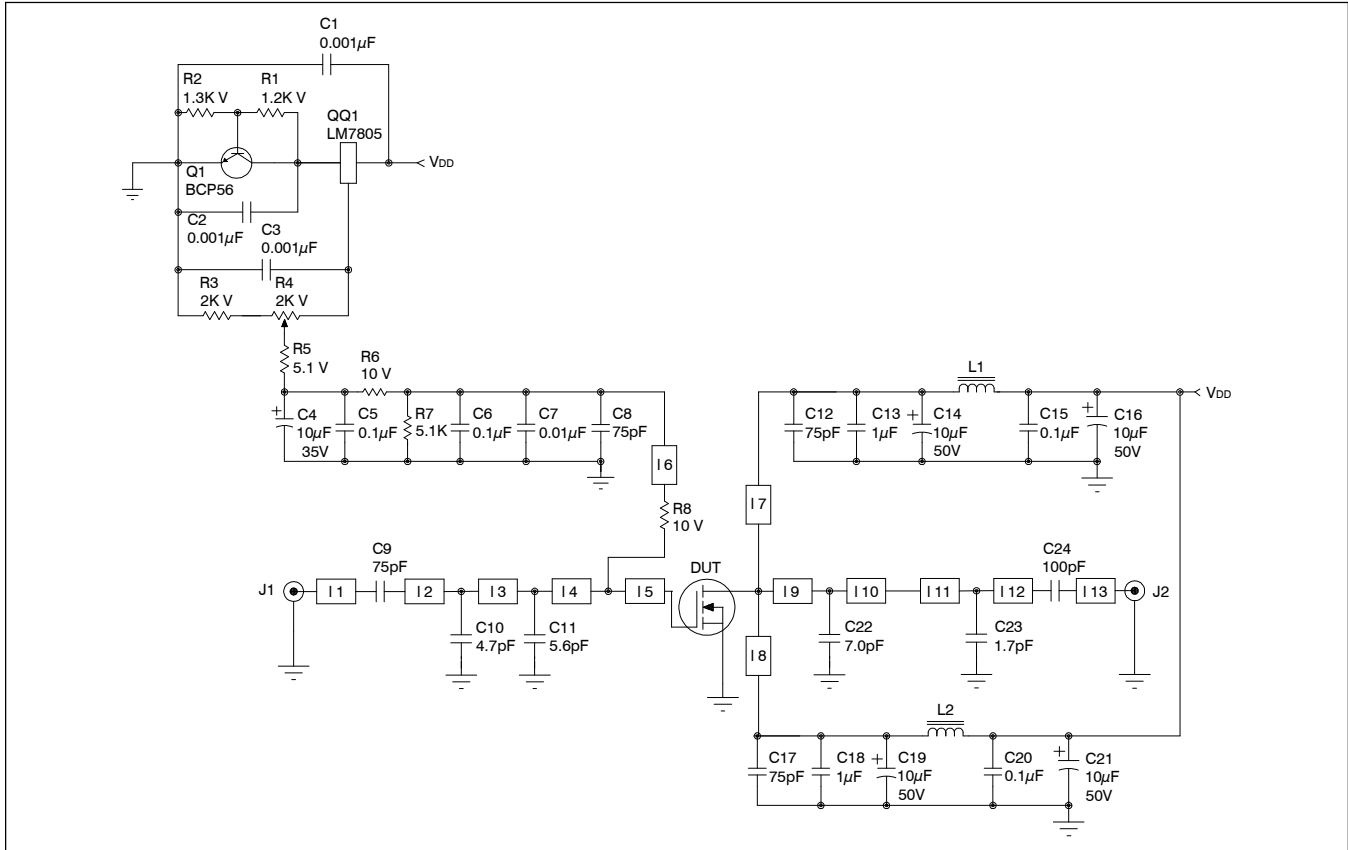

Reference circuit schematic diagram for $f = 760 \text{ MHz}$

Circuit Assembly Information

DUT	PTFA070601E or PTFA070601F	LDMOS Transistor	
PCB	0.76 mm [.030"] thick, $\epsilon_r = 4.5$	Rogers TMM4	2 oz. copper

Microstrip	Electrical Characteristics at 760 MHz	Dimensions: L x W (mm)	Dimensions: L x W (in.)
ℓ_1	0.056λ , 50.0 Ω	12.19 x 1.37	0.480 x 0.054
ℓ_2	0.091λ , 50.0 Ω	19.81 x 1.37	0.780 x 0.054
ℓ_3	0.016λ , 50.0 Ω	3.56 x 1.37	0.140 x 0.054
ℓ_4	0.011λ , 50.0 Ω	2.29 x 1.37	0.090 x 0.054
ℓ_5	0.050λ , 7.5 Ω	9.58 x 16.21	0.377 x 0.638
ℓ_6	0.128λ , 66.5 Ω	28.45 x 0.79	1.120 x 0.031
ℓ_7, ℓ_8	0.123λ , 52.2 Ω	26.67 x 1.27	1.050 x 0.050
ℓ_9	0.146λ , 11.0 Ω	28.58 x 10.54	1.125 x 0.415
ℓ_{10}	0.005λ , 11.0 Ω	0.97 x 10.54	0.038 x 0.415
ℓ_{11}	0.075λ , 37.8 Ω	15.82 x 2.16	0.623 x 0.085
ℓ_{12}	0.026λ , 37.8 Ω	5.56 x 2.16	0.219 x 0.085
ℓ_{13}	0.022λ , 50.0 Ω	4.70 x 1.37	0.185 x 0.054

Reference Circuit (cont.)

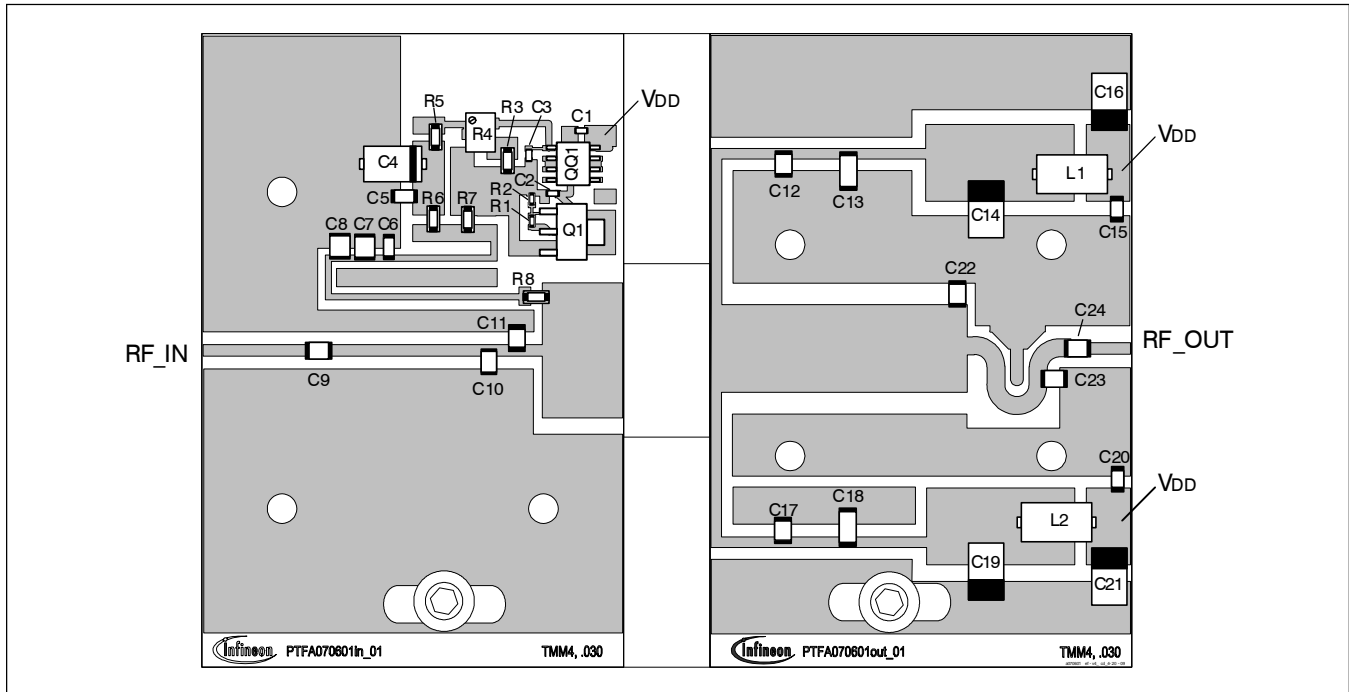

Reference circuit schematic diagram for $f = 760 \text{ MHz}$

Component	Description	Suggested Manufacturer	P/N or Comment
C1, C2, C3	Capacitor, 0.001 μF	Digi-Key	PCC1772CT-ND
C4	Tantalum capacitor, 10 μF , 35 V	Digi-Key	399-1655-2-ND
C5, C6, C15, C20	Capacitor, 0.1 μF	Digi-Key	PCC104BCT-ND
C7	Capacitor, 0.01 μF	ATC	200B 103
C8, C9, C12, C17	Ceramic capacitor, 75 pF	ATC	100B 750
C10	Ceramic capacitor, 4.7 pF	ATC	100B 4R7
C11	Ceramic capacitor, 5.6 pF	ATC	100B 5R6
C13, C18	Capacitor, 1.0 μF	ATC	920C105
C14, C16, C19, C21	Tantalum capacitor, 10 μF , 50 V	Garrett Electronics	TPSE106K050R0400
C22	Ceramic capacitor, 7.0 pF	ATC	100B 7R0
C23	Ceramic capacitor, 1.7 pF	ATC	100B 1R7
C24	Ceramic capacitor, 100 pF	ATC	100B 101
L1, L2	Ferrite, 8.9 mm	Elna Magnetics	BDS 4.6/3/8.9-4S2
Q1	Transistor	Infineon Technologies	BCP56
QQ1	Voltage regulator	National Semiconductor	LM7805
R1	Chip resistor 1.2k ohms	Digi-Key	P1.2KGCT-ND
R2	Chip resistor 1.3k ohms	Digi-Key	P1.3KGCT-ND
R3	Chip resistor 2k ohms	Digi-Key	P2KECT-ND
R4	Potentiometer 2k ohms	Digi-Key	3224W-202ETR-ND
R5, R7	Chip resistor 5.1k ohms	Digi-Key	P5.1KECT-ND
R6, R8	Chip resistor 10 ohms	Digi-Key	P10ECT-ND

*Gerber files for this circuit available on request

Package Outline Specifications

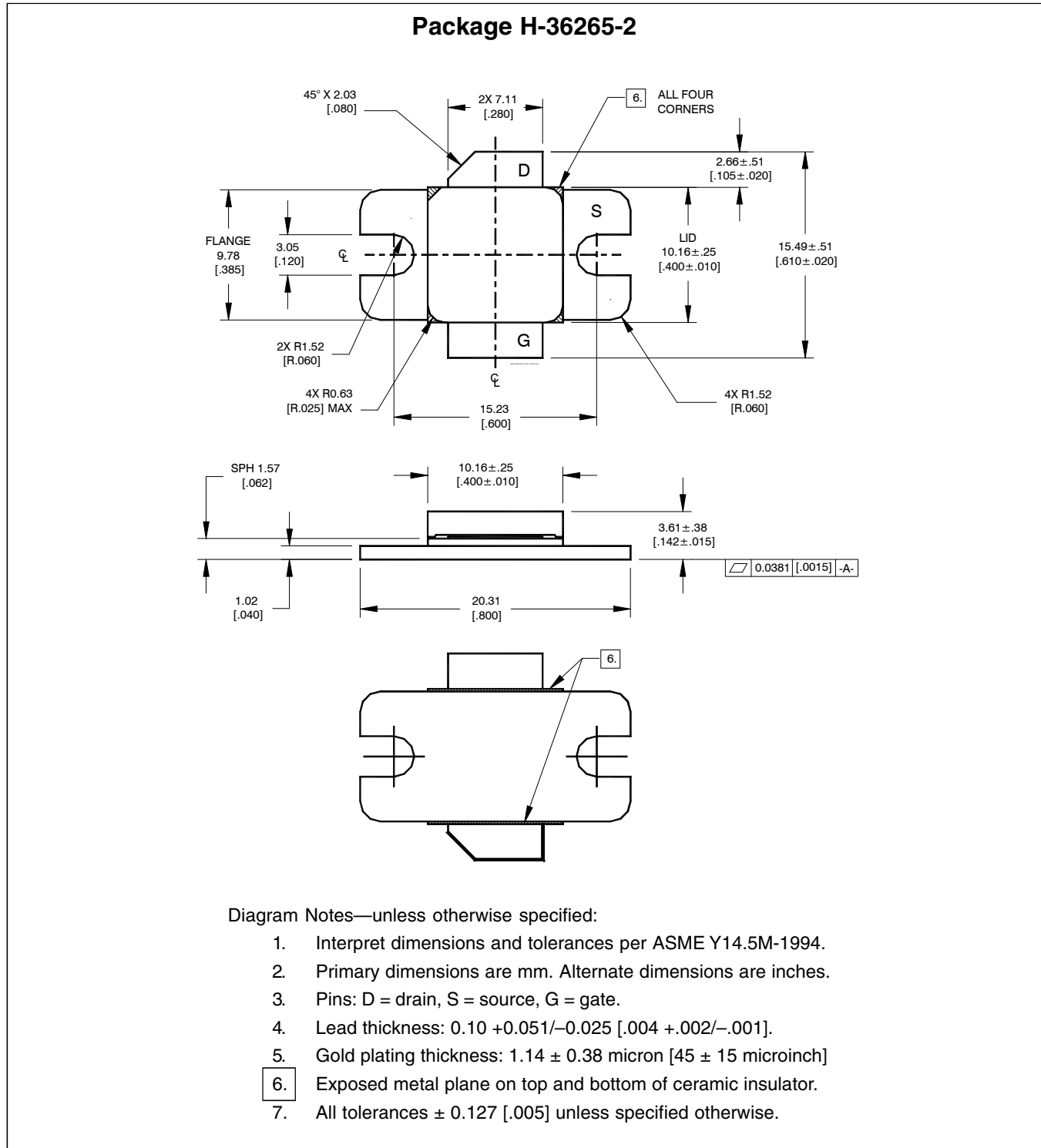

Package Outline Specifications (cont.)

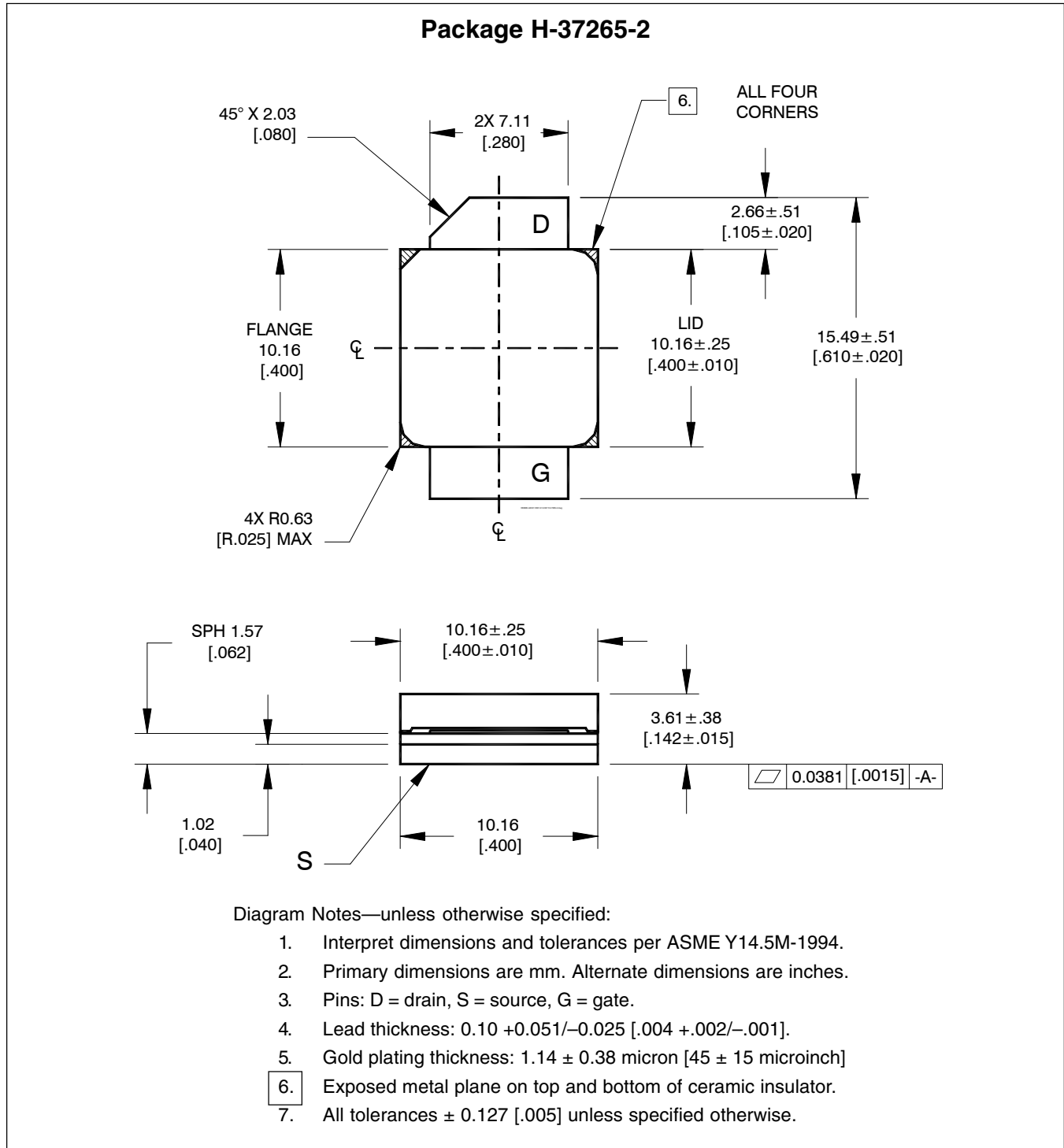

Find the latest and most complete information about products and packaging at the Infineon Internet page
<http://www.infineon.com/rfpower>

Page	Subjects (major changes since last revision)

We Listen to Your Comments

Any information within this document that you feel is wrong, unclear or missing at all?
Your feedback will help us to continuously improve the quality of this document.
Please send your proposal (including a reference to this document) to:

highpowerRF@infineon.com

To request other information, contact us at:
+1 877 465 3667 (1-877-GO-LDMOS) USA
or +1 408 776 0600 International

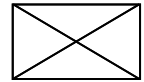

Edition 2009-04-16

Published by

Infineon Technologies AG
81726 Munich, Germany

© 2009 Infineon Technologies AG
All Rights Reserved.

Legal Disclaimer

The information given in this document shall in no event be regarded as a guarantee of conditions or characteristics. With respect to any examples or hints given herein, any typical values stated herein and/or any information regarding the application of the device, Infineon Technologies hereby disclaims any and all warranties and liabilities of any kind, including without limitation, warranties of non-infringement of intellectual property rights of any third party.

Information

For further information on technology, delivery terms and conditions and prices, please contact the nearest Infineon Technologies Office (www.infineon.com/rfpower).

Warnings

Due to technical requirements, components may contain dangerous substances. For information on the types in question, please contact the nearest Infineon Technologies Office.

Infineon Technologies components may be used in life-support devices or systems only with the express written approval of Infineon Technologies, if a failure of such components can reasonably be expected to cause the failure of that life-support device or system or to affect the safety or effectiveness of that device or system. Life support devices or systems are intended to be implanted in the human body or to support and/or maintain and sustain and/or protect human life. If they fail, it is reasonable to assume that the health of the user or other persons may be endangered.