

## Thermally-Enhanced High Power RF LDMOS FETs 220 W, 920 – 960 MHz

### Description

The PTFA092201E and PTFA092201F are 220-watt, internally-matched LDMOS FETs intended for EDGE and WCDMA applications in the 920 to 960 MHz band. Manufactured with Infineon's advanced LDMOS process, these devices provide excellent thermal performance and superior reliability.

PTFA092201E  
Package H-36260-2

PTFA092201F  
Package H-37260-2

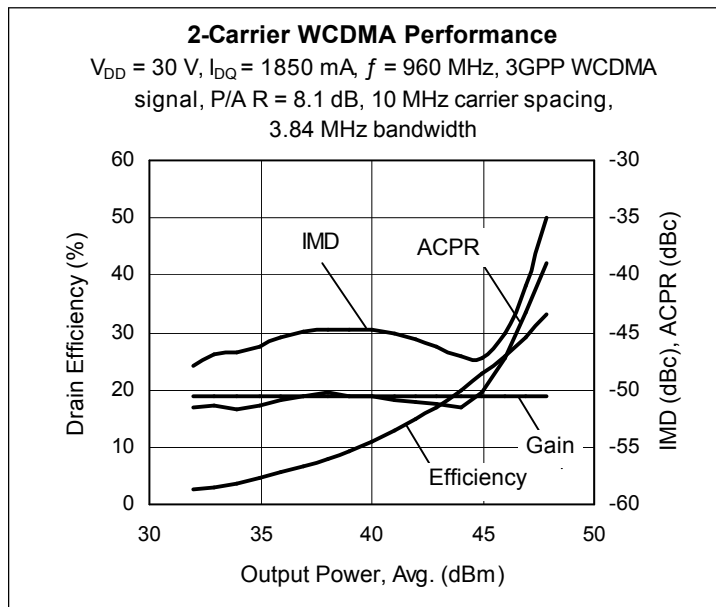
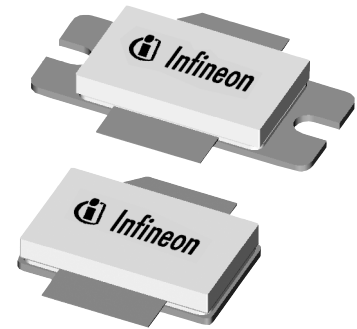

### Features

- Pb-free, RoHS-compliant and thermally-enhanced packages
- Broadband internal matching
- Typical two-carrier WCDMA performance at 960 MHz, 30 V
  - Average output power = 55 W
  - Linear Gain = 18.5 dB
  - Efficiency = 30%
  - Intermodulation distortion = -37 dBc
  - Adjacent channel power = -39 dBc
- Typical CW performance, 960 MHz, 30 V
  - Output power at P-1dB = 250 W
  - Gain = 17.5 dB
  - Efficiency = 59%
- Integrated ESD protection: Human Body Model, Class 2 (minimum)
- Excellent thermal stability, low HCI drift
- Capable of handling 10:1 VSWR @ 30 V, 220 W (CW) output power

### RF Characteristics

**Two-carrier WCDMA Measurements** (not subject to production test—verified by design/characterization in Infineon test fixture)

$V_{DD} = 30\text{ V}$ ,  $I_{DQ} = 1850\text{ mA}$ ,  $P_{OUT} = 55\text{ W}$  average

$f_1 = 950\text{ MHz}$ ,  $f_2 = 960\text{ MHz}$ , 3GPP signal, channel bandwidth = 3.84 MHz, peak/average = 8.1 dB @ 0.01% CCDF

Characteristic	Symbol	Min	Typ	Max	Unit
Intermodulation Distortion	IMD	—	-37	—	dBc
Gain	$G_{ps}$	—	18.5	—	dB
Drain Efficiency	$\eta_D$	—	30	—	%

All published data at  $T_{CASE} = 25\text{ °C}$  unless otherwise indicated

**ESD:** Electrostatic discharge sensitive device—observe handling precautions!

## RF Characteristics (cont.)

### Two-tone Measurements (tested in Infineon test fixture)

$V_{DD} = 30\text{ V}$ ,  $I_{DQ} = 1850\text{ mA}$ ,  $P_{OUT} = 220\text{ W PEP}$ ,  $f = 960\text{ MHz}$ , tone spacing = 1 MHz

Characteristic	Symbol	Min	Typ	Max	Unit
Gain	$G_{ps}$	17.5	18.5	—	dB
Drain Efficiency	$\eta_D$	42	44	—	%
Intermodulation Distortion	IMD	—	—	-28	dBc

## DC Characteristics

Characteristic	Conditions	Symbol	Min	Typ	Max	Unit
Drain-Source Breakdown Voltage	$V_{GS} = 0\text{ V}$ , $I_{DS} = 10\text{ mA}$	$V_{(BR)DSS}$	65	—	—	V
Drain Leakage Current	$V_{DS} = 28\text{ V}$ , $V_{GS} = 0\text{ V}$	$I_{DSS}$	—	—	1.0	$\mu\text{A}$
	$V_{DS} = 63\text{ V}$ , $V_{GS} = 0\text{ V}$	$I_{DSS}$	—	—	10.0	$\mu\text{A}$
On-State Resistance	$V_{GS} = 10\text{ V}$ , $V_{DS} = 0.1\text{ V}$	$R_{DS(on)}$	—	0.04	—	$\Omega$
Operating Gate Voltage	$V_{DS} = 30\text{ V}$ , $I_{DQ} = 1850\text{ mA}$	$V_{GS}$	2.0	2.5	3.0	V
Gate Leakage Current	$V_{GS} = 10\text{ V}$ , $V_{DS} = 0\text{ V}$	$I_{GSS}$	—	—	1.0	$\mu\text{A}$

## Maximum Ratings

Parameter	Symbol	Value	Unit
Drain-Source Voltage	$V_{DSS}$	65	V
Gate-Source Voltage	$V_{GS}$	-0.5 to +12	V
Junction Temperature	$T_J$	200	$^{\circ}\text{C}$
Total Device Dissipation	$P_D$	700	W
		Above 25 $^{\circ}\text{C}$ derate by	4.0
Storage Temperature Range	$T_{STG}$	-40 to +150	$^{\circ}\text{C}$
Thermal Resistance ( $T_{CASE} = 70\text{ }^{\circ}\text{C}$ , 220 W CW)	$R_{\theta JC}$	0.25	$^{\circ}\text{C}/\text{W}$

## Ordering Information

Type and Version	Package Outline	Package Description	Shipping	Marking
PTFA092201E V4	H-36260-2	Thermally-enhanced slotted flange, single-ended	Tray	PTFA092201E
PTFA092201F V4	H-37260-2	Thermally-enhanced earless flange, single-ended	Tray	PTFA092201F

**Typical Performance** (data taken in a production test fixture)

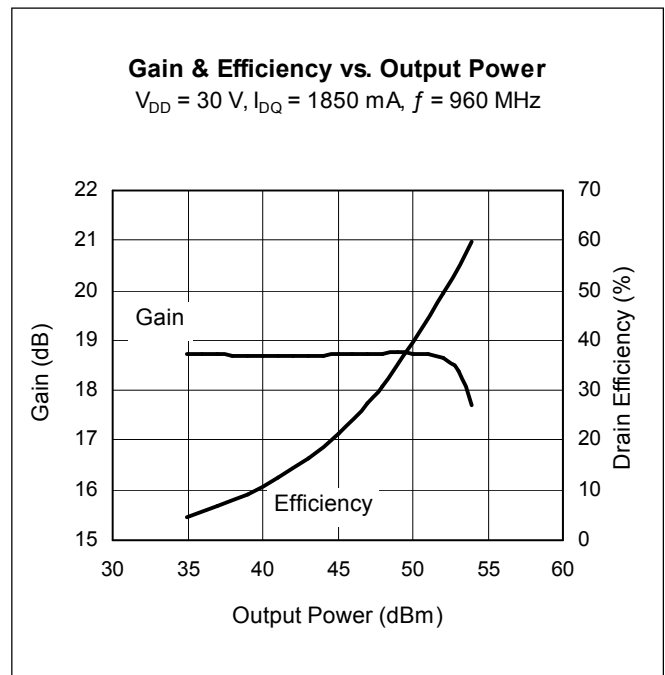
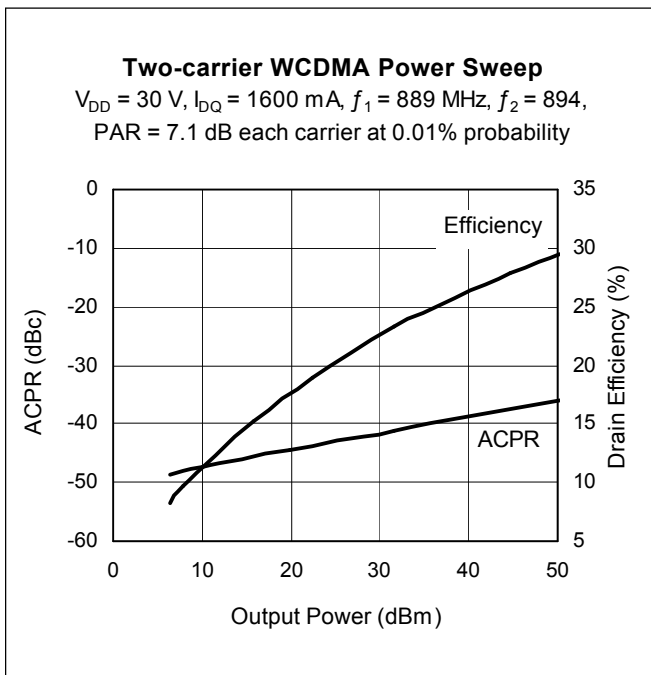
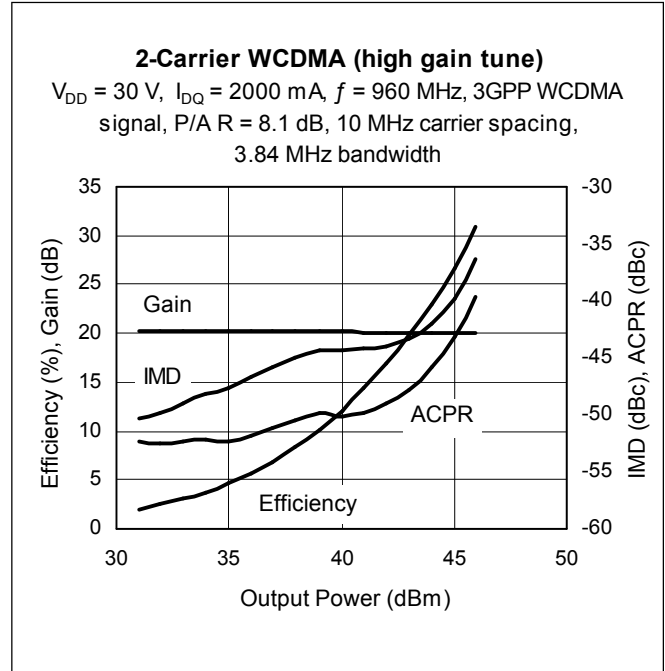
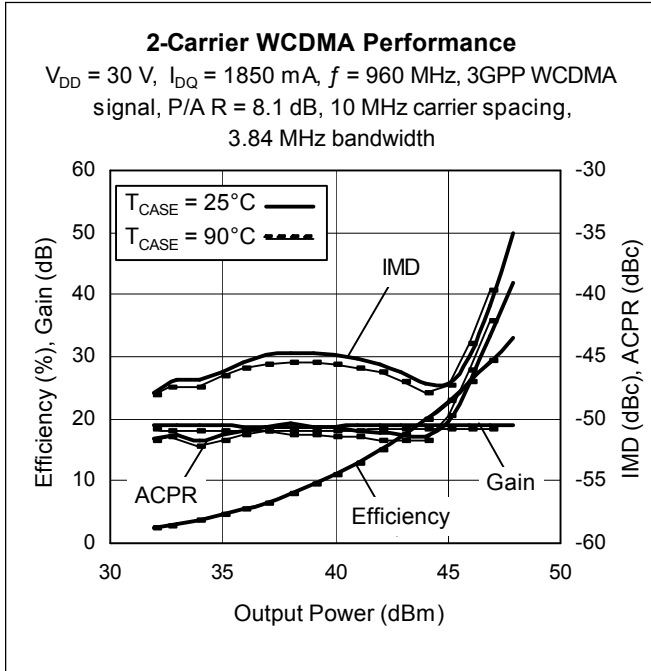

Typical Performance (cont.)

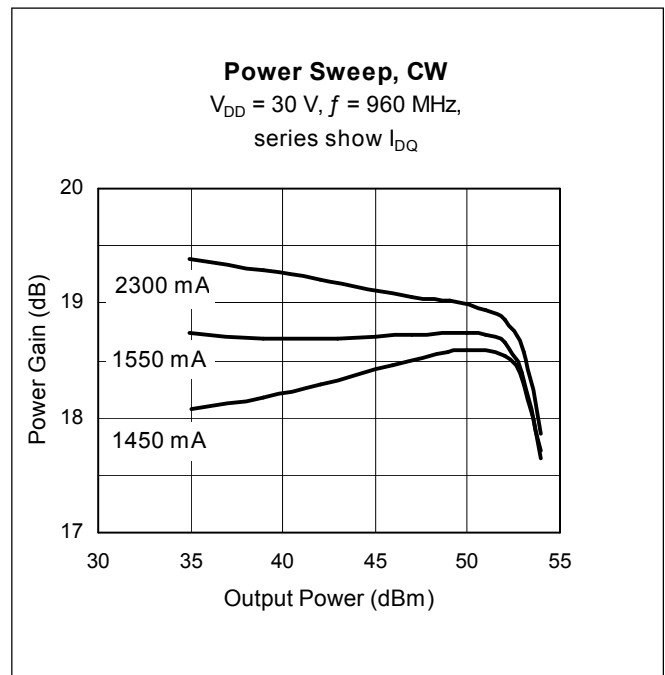
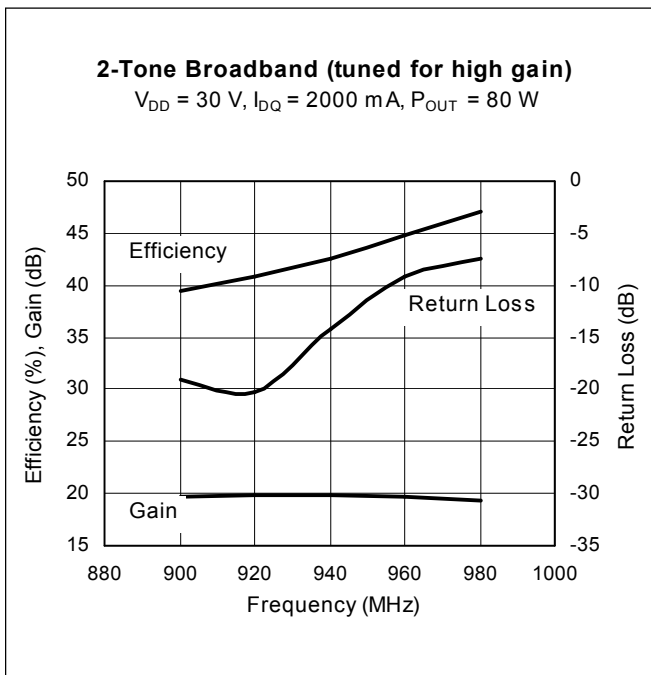
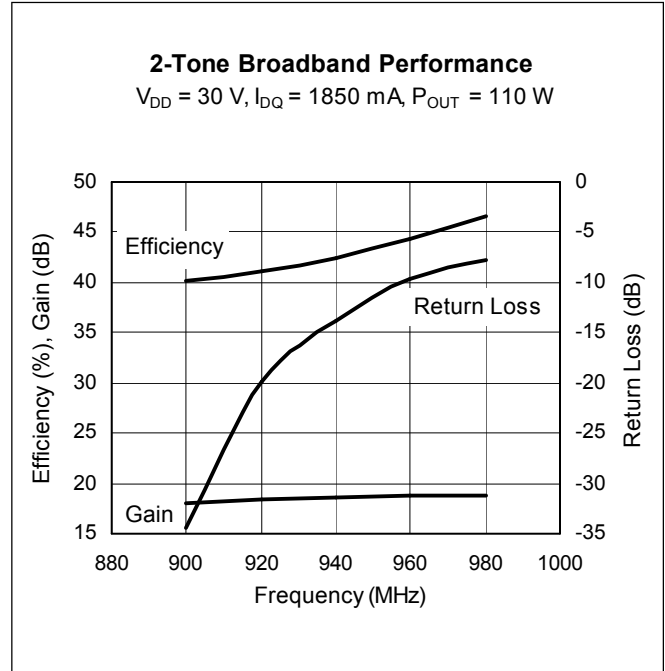
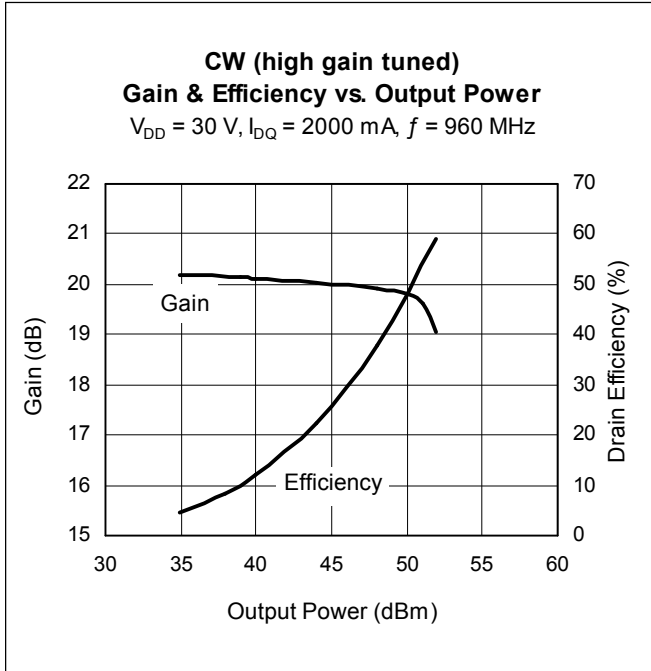

Typical Performance (cont.)

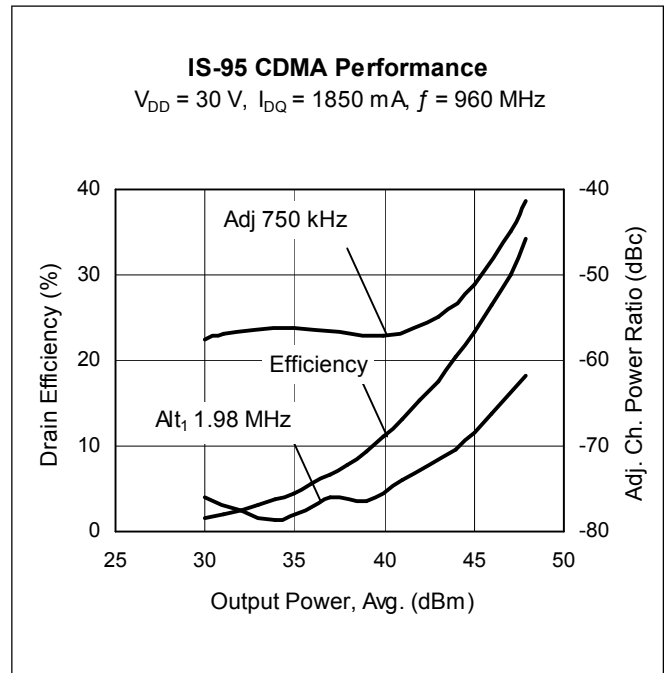
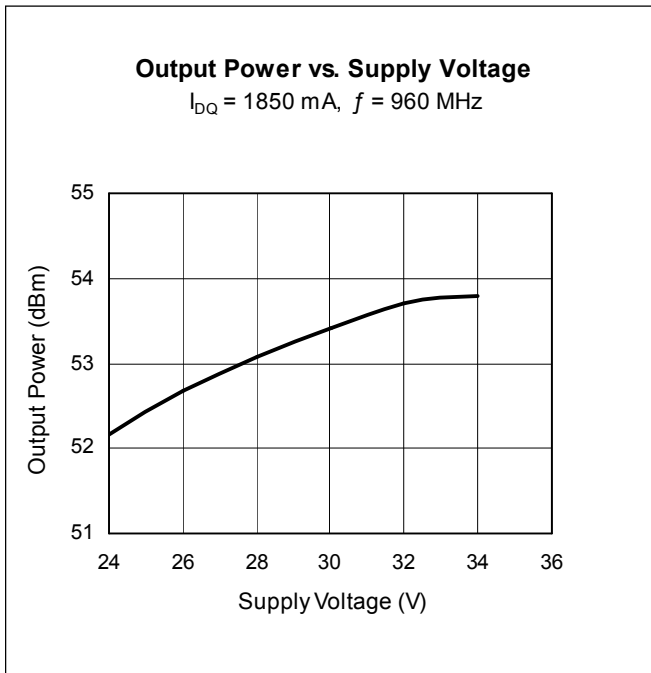
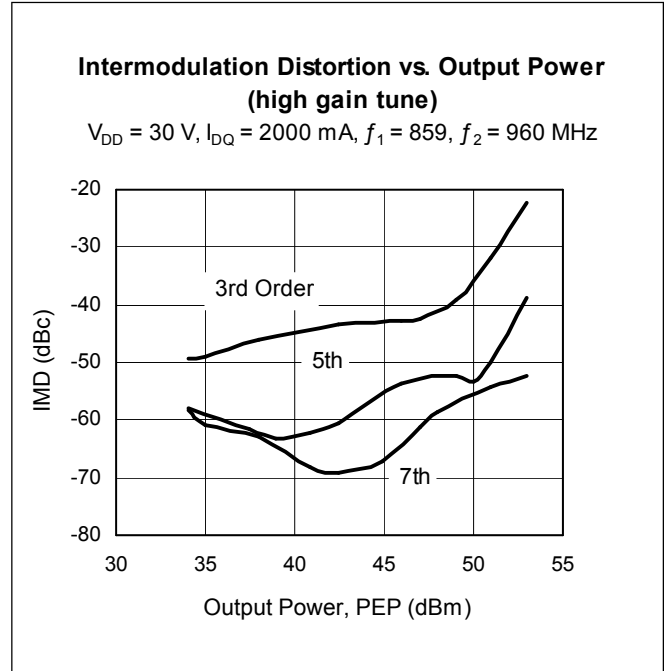
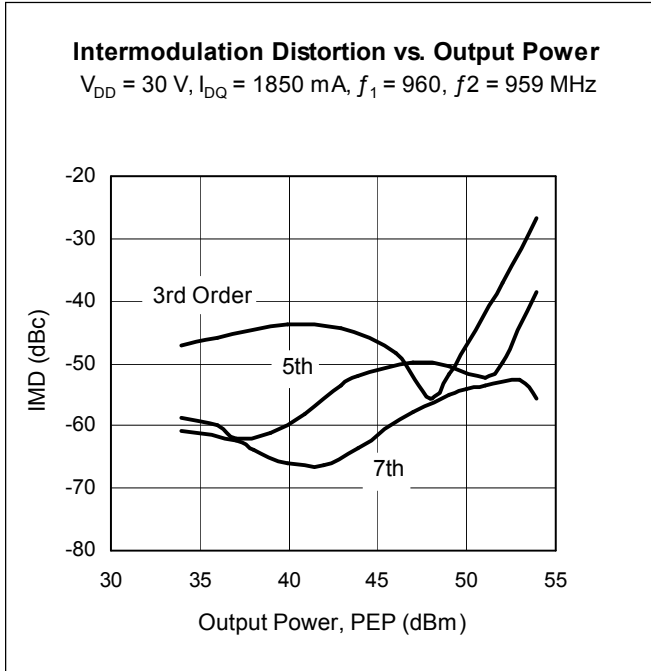

**Typical Performance (cont.)**

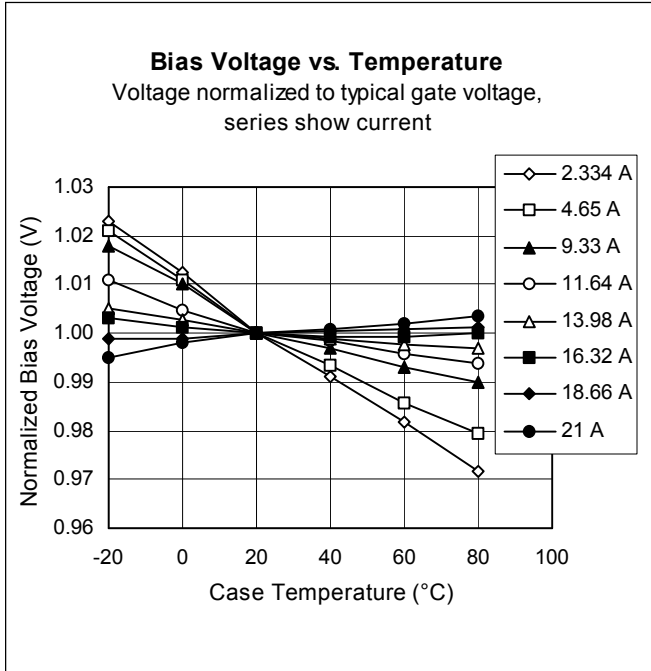

**Broadband Circuit Impedance**

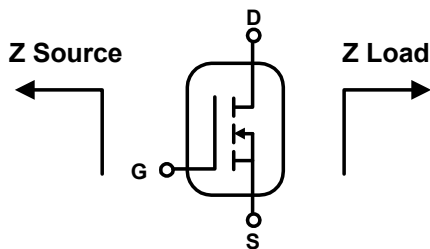

Frequency MHz	Z Source W		Z Load W	
	R	jX	R	jX
900	2.256	-1.363	1.722	-0.413
920	2.250	-1.094	1.653	-0.109
940	2.282	-0.826	1.651	0.186
960	2.239	-0.545	1.562	0.518
980	2.288	-0.307	1.562	0.795

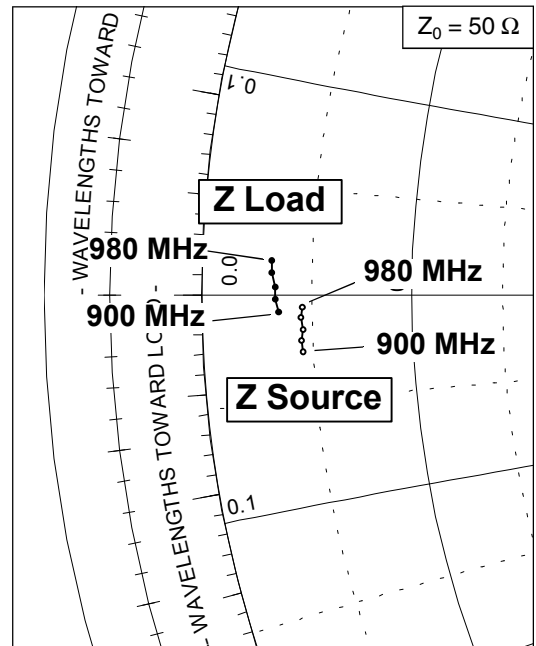

### Reference Circuit

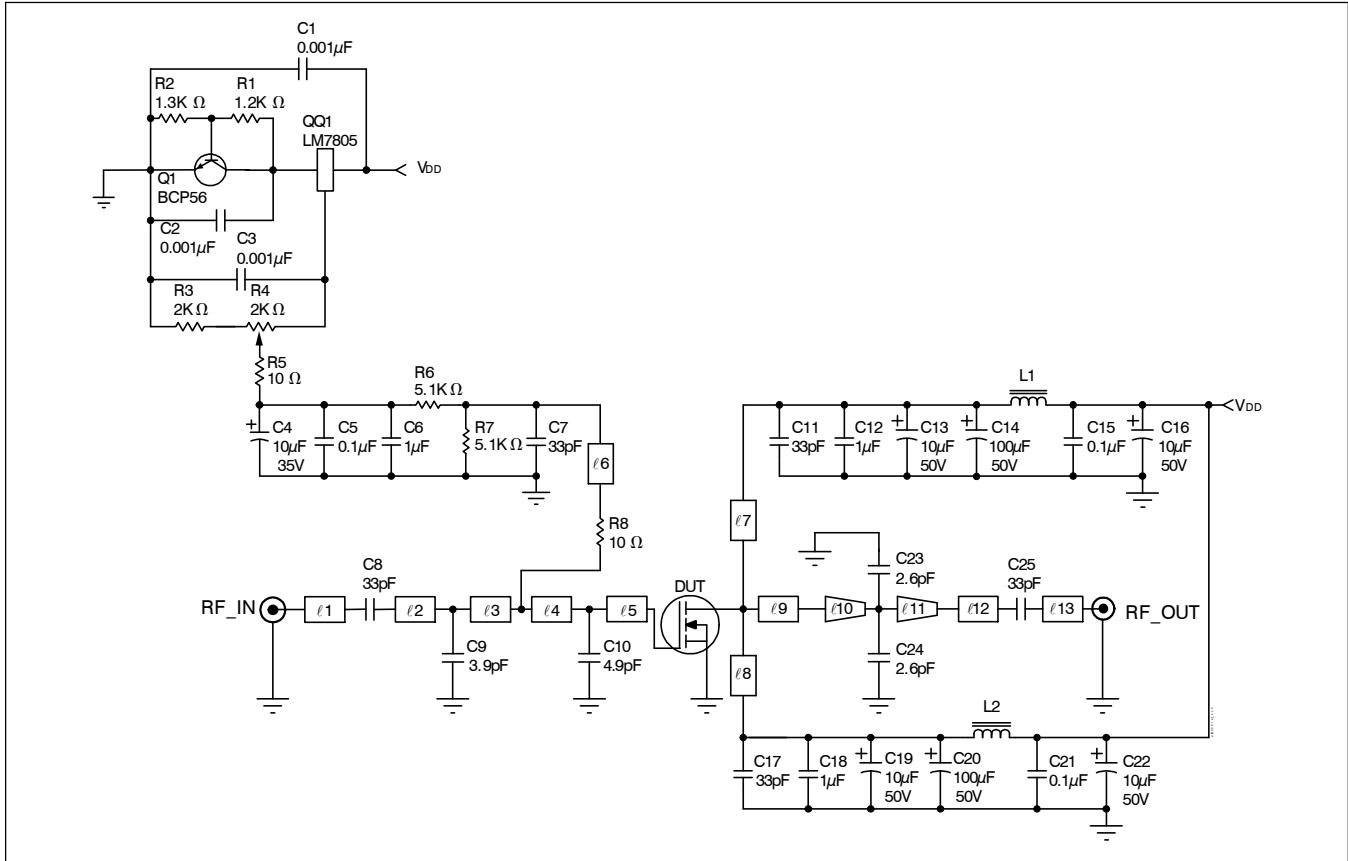

Reference circuit block diagram for  $f = 960 \text{ MHz}$

### Circuit Assembly Information

DUT	PTFA092201E or PTFA092201F	LDMOS Transistor	
PCB	0.76 mm [.030"] thick, $\epsilon_r = 3.48$	Rogers RO4350	1 oz. copper

Microstrip	Electrical Characteristics at 960 MHz <sup>1</sup>	Dimensions: L x W (mm)	Dimensions: L x W (in.)
$l_1$	0.068 $\lambda$ , 52.0 $\Omega$	12.78 x 1.60	0.503 x 0.063
$l_2$	0.041 $\lambda$ , 38.0 $\Omega$	7.57 x 2.54	0.298 x 0.100
$l_3$	0.040 $\lambda$ , 38.0 $\Omega$	7.34 x 2.54	0.289 x 0.100
$l_4$	0.092 $\lambda$ , 7.8 $\Omega$	15.95 x 17.83	0.628 x 0.702
$l_5$	0.025 $\lambda$ , 7.8 $\Omega$	4.29 x 17.83	0.169 x 0.702
$l_6$	0.208 $\lambda$ , 78.3 $\Omega$	40.64 x 0.74	1.600 x 0.029
$l_7, l_8$	0.200 $\lambda$ , 60.1 $\Omega$	40.64 x 1.24	1.500 x 0.049
$l_9$	0.102 $\lambda$ , 8.4 $\Omega$	17.65 x 16.48	0.695 x 0.649
$l_{10}$ (taper)	0.021 $\lambda$ , 8.4 $\Omega$ / 10.1 $\Omega$	3.56 x 16.48 / 13.36	0.140 x 0.649 / 0.526
$l_{11}$ (taper)	0.094 $\lambda$ , 10.1 $\Omega$ / 37.7 $\Omega$	16.38 x 13.36 / 2.64	0.645 x 0.526 / 0.104
$l_{12}$	0.022 $\lambda$ , 37.0 $\Omega$	4.04 x 2.64	0.159 x 0.104
$l_{13}$	0.035 $\lambda$ , 52.0 $\Omega$	6.55 x 1.60	0.258 x 0.063

<sup>1</sup>Electrical characteristics are rounded.

Reference Circuit (cont.)

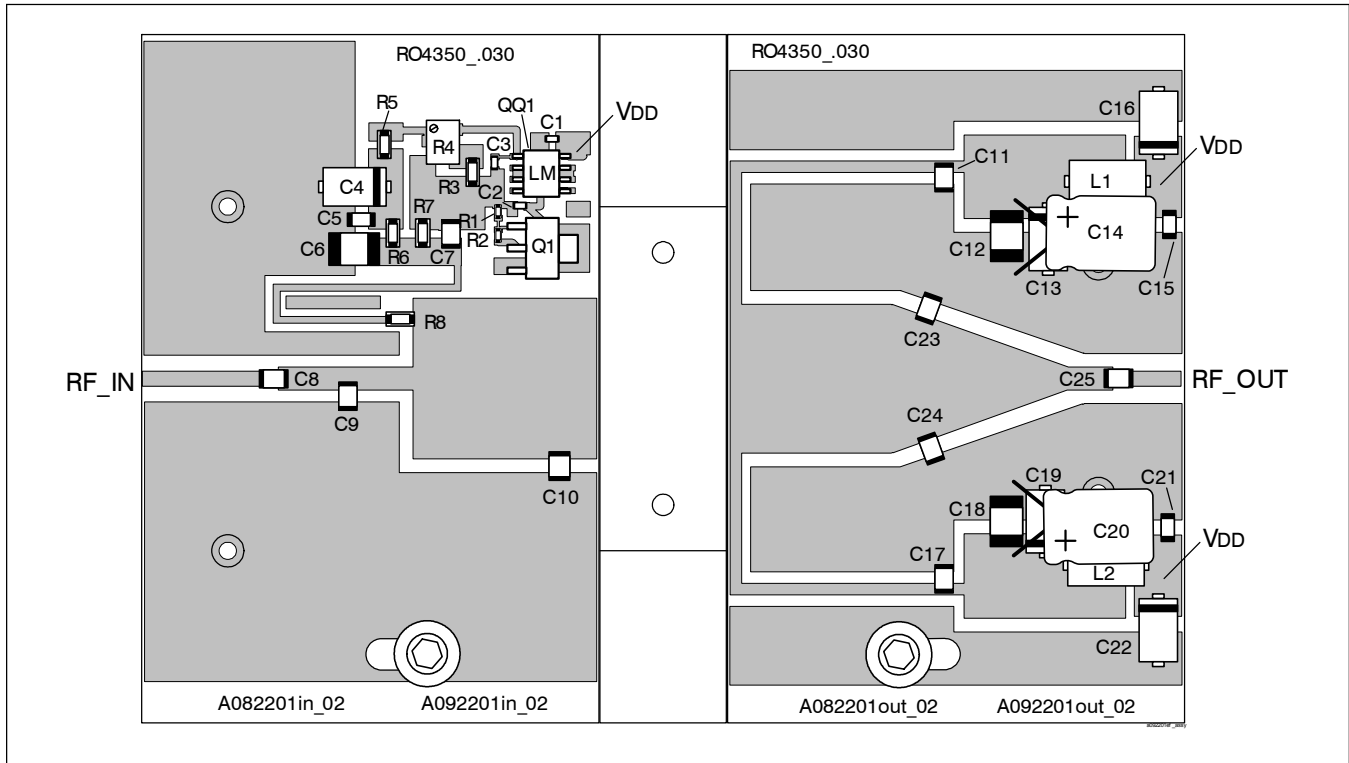

Reference circuit assembly diagram (not to scale)\*

Component	Description	Suggested Manufacturer	P/N or Comment
C1, C2, C3	Capacitor, 0.001 $\mu$ F	Digi-Key	PCC1772CT-ND
C4	Tantalum capacitor, 10 $\mu$ F, 35 V	Digi-Key	399-1655-2-ND
C5, C15, C21	Capacitor, 0.1 $\mu$ F	Digi-Key	PCC104BCT-ND
C6, C12, C18	Capacitor, 1 $\mu$ F	ATC	920C105
C7, C8, C11, C17, C25	Ceramic capacitor, 33 pF	ATC	100B 330
C9	Ceramic capacitor, 3.9 pF	ATC	100B 3R9
C10	Ceramic capacitor, 4.9 pF	ATC	100B 4R9
C13, C16, C19, C22	Tantalum capacitor, 10 $\mu$ F, 50 V	Garrett Electronics	TPSE106K050R0400
C14, C20	Electrolytic capacitor, 100 $\mu$ F, 50 V	Digi-Key	P5571-ND
C23, C24	Ceramic capacitor, 2.6 pF	ATC	100B 2R6
L1, L2	Ferrite, 8.9 mm	Elna Magnetics	BDS 4.6/3/8.9-4S2
Q1	Transistor	Infineon Technologies	BCP56
QQ1	Voltage regulator	National Semiconductor	LM7805
R1	Chip resistor 1.2 k-ohms	Digi-Key	P1.2KGCT-ND
R2	Chip resistor 1.3 k-ohms	Digi-Key	P1.3KGCT-ND
R3	Chip resistor 2 k-ohms	Digi-Key	P2KECT-ND
R4	Potentiometer 2 k-ohms	Digi-Key	3224W-202ETR-ND
R5, R8	Chip resistor 10 ohms	Digi-Key	P10ECT-ND
R6, R7	Chip resistor 5.1 k-ohms	Digi-Key	P5.1KECT-ND

\*Gerber Files for this circuit available on request



## Package Outline Specifications

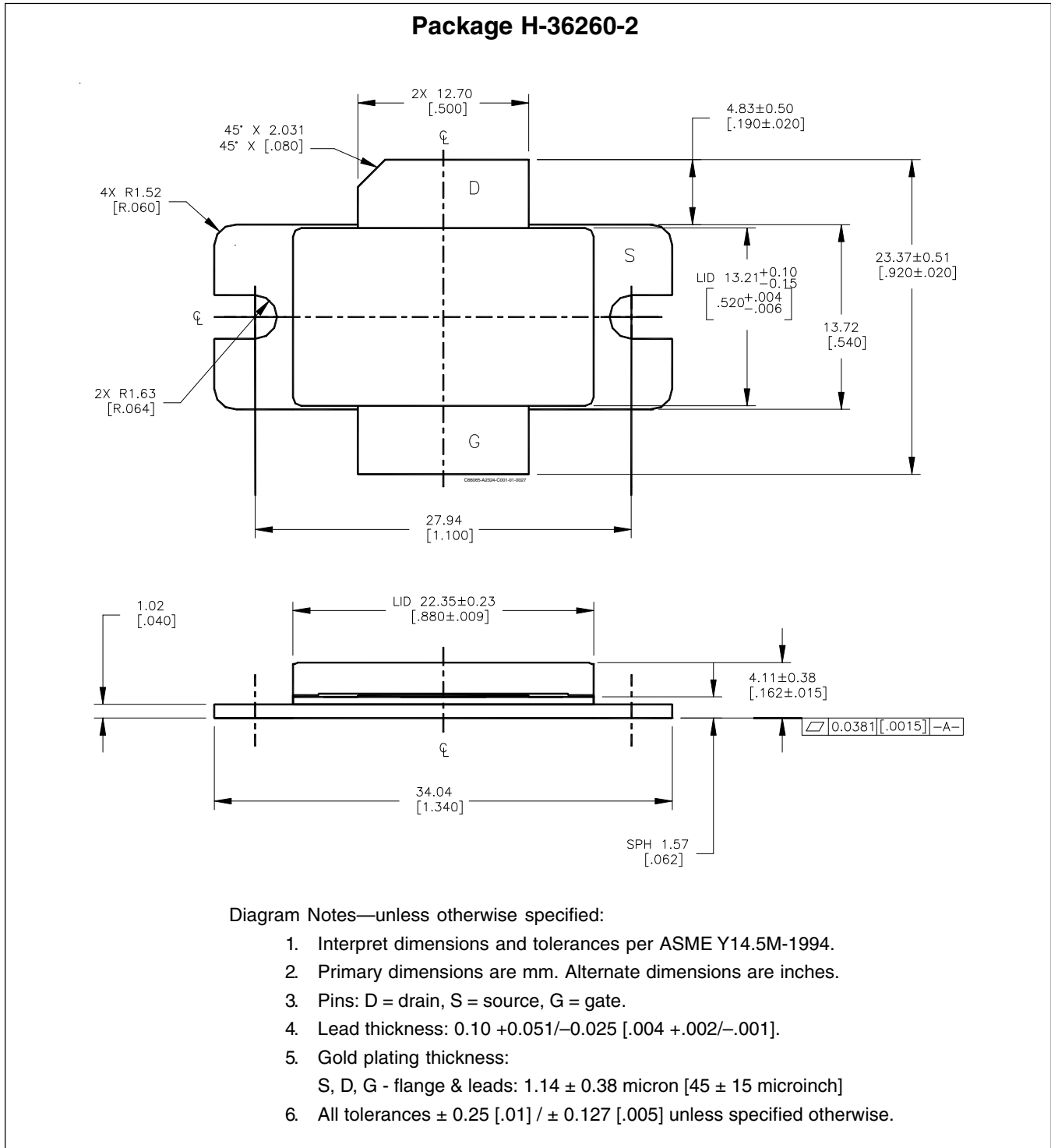

Find the latest and most complete information about products and packaging at the Infineon Internet page  
<http://www.infineon.com/rfpower>

Package Outline Specifications (cont.)

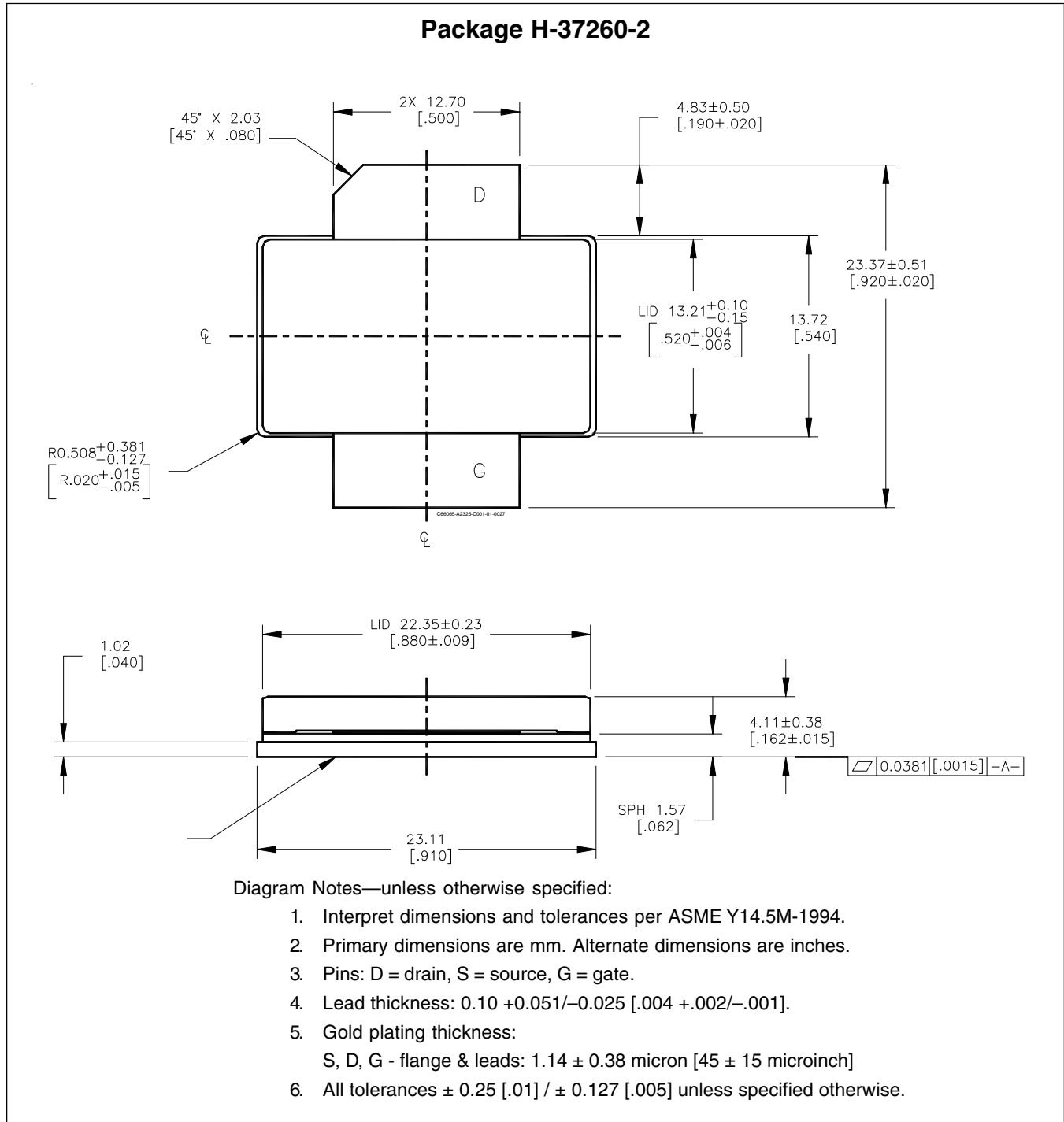

Find the latest and most complete information about products and packaging at the Infineon Internet page  
<http://www.infineon.com/rfpower>

Revision History: 2009-02-20

Data Sheet

Previous Version: 2006-06-05, Data Sheet Rev. 02, Product V1

Page	Subjects (major changes since last revision)
all	New product version V4, new package diagram and information.
8	Fixed typing error

**We Listen to Your Comments**

Any information within this document that you feel is wrong, unclear or missing at all?  
Your feedback will help us to continuously improve the quality of this document.

Please send your proposal (including a reference to this document) to:

[highpowerRF@infineon.com](mailto:highpowerRF@infineon.com)

To request other information, contact us at:  
+1 877 465 3667 (1-877-GO-LDMOS) USA  
or +1 408 776 0600 International

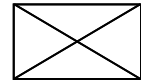

**Edition 2009-02-20**

**Published by**

**Infineon Technologies AG**  
**81726 Munich, Germany**

**© 2006 Infineon Technologies AG**

**All Rights Reserved.**

**Legal Disclaimer**

The information given in this document shall in no event be regarded as a guarantee of conditions or characteristics. With respect to any examples or hints given herein, any typical values stated herein and/or any information regarding the application of the device, Infineon Technologies hereby disclaims any and all warranties and liabilities of any kind, including without limitation, warranties of non-infringement of intellectual property rights of any third party.

**Information**

For further information on technology, delivery terms and conditions and prices, please contact the nearest Infineon Technologies Office ([www.infineon.com/rfpower](http://www.infineon.com/rfpower)).

**Warnings**

Due to technical requirements, components may contain dangerous substances. For information on the types in question, please contact the nearest Infineon Technologies Office.

Infineon Technologies components may be used in life-support devices or systems only with the express written approval of Infineon Technologies, if a failure of such components can reasonably be expected to cause the failure of that life-support device or system or to affect the safety or effectiveness of that device or system. Life support devices or systems are intended to be implanted in the human body or to support and/or maintain and sustain and/or protect human life. If they fail, it is reasonable to assume that the health of the user or other persons may be endangered.