

Thermally-Enhanced High Power RF LDMOS FETs 220 W, 920 – 960 MHz

Description

The PTFA092213EL and PTFA092213FL are 220-watt, internally-matched LDMOS FETs designed for use in cellular power amplifier applications in the 920 to 960 MHz band. These devices feature internal I/O matching and thermally-enhanced open-cavity ceramic packages with slotted or earless flanges. Manufactured with Infineon's advanced LDMOS process, these devices provide excellent thermal performance and superior reliability.

PTFA092213EL
Package H-33288-6



PTFA092213FL
Package H-34288-4/2

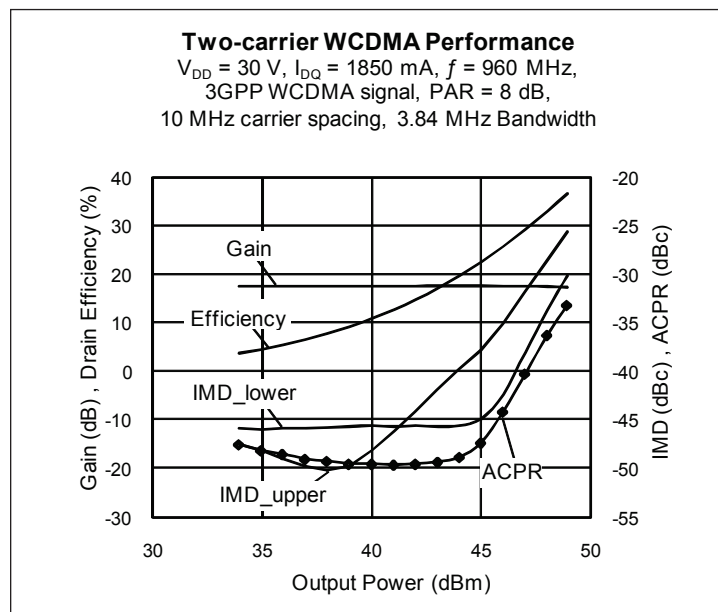

Features

- Broadband internal matching
- Typical two-carrier WCDMA performance at 960 MHz, 30 V
 - Average output power = 50 W
 - Linear Gain = 17.5 dB
 - Efficiency = 29%
 - Intermodulation distortion = -32 dBc
 - Adjacent channel power = -42.5 dBc
- Typical CW performance, 960 MHz, 30 V
 - Output power at $P_{1\text{dB}}$ = 250 W
 - Linear Gain = 17.5 dB
 - Efficiency = 52%
- Integrated ESD protection: Human Body Model, Class 2 (minimum)
- Excellent thermal stability, low HCI drift
- Capable of handling 10:1 VSWR @ 30 V, 220 W (CW) output power
- Pb-free, RoHS-compliant

RF Characteristics

Two-carrier WCDMA Measurements (not subject to production test—verified by design/characterization in Infineon test fixture)
 $V_{DD} = 30\text{ V}$, $I_{DQ} = 1850\text{ mA}$, $P_{OUT} = 50\text{ W}$ average, $f_1 = 950\text{ MHz}$, $f_2 = 960\text{ MHz}$, 3GPP signal, channel bandwidth = 3.84 MHz, peak/average = 8 dB @ 0.01% CCDF

Characteristic	Symbol	Min	Typ	Max	Unit
Gain	G_{ps}	—	17.5	—	dB
Drain Efficiency	η_D	—	29	—	%
Intermodulation Distortion	IMD	—	-32	—	dBc

All published data at $T_{CASE} = 25^\circ\text{C}$ unless otherwise indicated

ESD: Electrostatic discharge sensitive device—observe handling precautions!

RF Characteristics (cont.)

Two-tone Measurements (tested in Infineon test fixture)

$V_{DD} = 30\text{ V}$, $I_{DQ} = 1850\text{ mA}$, $P_{OUT} = 200\text{ W PEP}$, $f = 960\text{ MHz}$, tone spacing = 1 MHz

Characteristic	Symbol	Min	Typ	Max	Unit
Gain	G_{ps}	17	17.5	—	dB
Drain Efficiency	η_D	40	42	—	%
Intermodulation Distortion	IMD	—	-30	-28	dBc

DC Characteristics

Characteristic	Conditions	Symbol	Min	Typ	Max	Unit
Drain-Source Breakdown Voltage	$V_{GS} = 0\text{ V}$, $I_{DS} = 10\text{ mA}$	$V_{(BR)DSS}$	65	—	—	V
Drain Leakage Current	$V_{DS} = 28\text{ V}$, $V_{GS} = 0\text{ V}$	I_{DSS}	—	—	1.0	μA
	$V_{DS} = 63\text{ V}$, $V_{GS} = 0\text{ V}$	I_{DSS}	—	—	10.0	μA
On-State Resistance	$V_{GS} = 10\text{ V}$, $V_{DS} = 0.1\text{ V}$	$R_{DS(on)}$	—	0.04	—	Ω
Operating Gate Voltage	$V_{DS} = 30\text{ V}$, $I_{DQ} = 1850\text{ mA}$	V_{GS}	2.0	2.5	3.0	V
Gate Leakage Current	$V_{GS} = 10\text{ V}$, $V_{DS} = 0\text{ V}$	I_{GSS}	—	—	1.0	μA

Maximum Ratings

Parameter	Symbol	Value	Unit
Drain-Source Voltage	V_{DSS}	65	V
Gate-Source Voltage	V_{GS}	-0.5 to +12	V
Junction Temperature	T_J	200	$^{\circ}\text{C}$
Storage Temperature Range	T_{STG}	-40 to +150	$^{\circ}\text{C}$
Thermal Resistance ($T_{CASE} = 70\text{ }^{\circ}\text{C}$, 220 W CW)	$R_{\theta JC}$	0.23	$^{\circ}\text{C/W}$

Ordering Information

Type and Version	Package Outline	Package Description	Shipping
PTFA092213EL V4	H-33288-6	Thermally-enhanced, slotted flange, single-ended	Tray
PTFA092213EL V4 R250	H-33288-6	Thermally-enhanced, slotted flange, single-ended	Tape & Reel, 250 pcs
PTFA092213FL V5	H-34288-4/2	Thermally-enhanced, earless flange, single-ended	Tray
PTFA092213FL V5 R250	H-34288-4/2	Thermally-enhanced, earless flange, single-ended	Tape & Reel, 250 pcs

Typical Performance

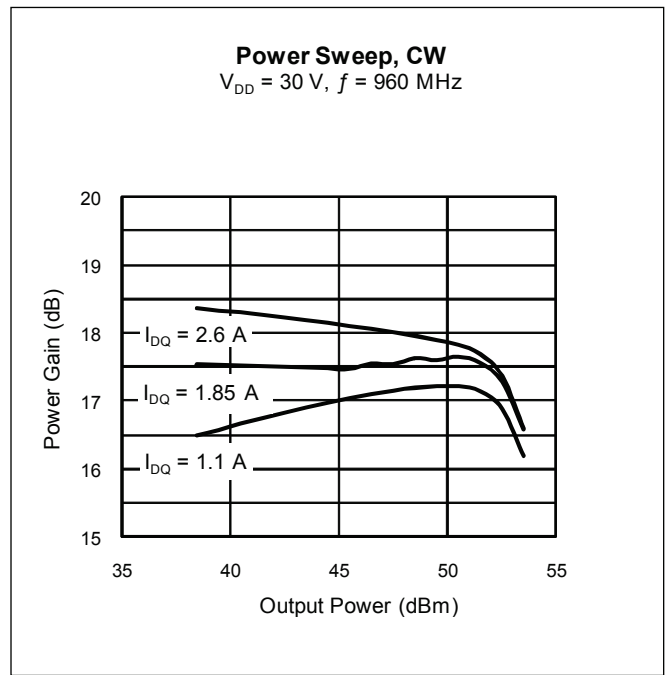
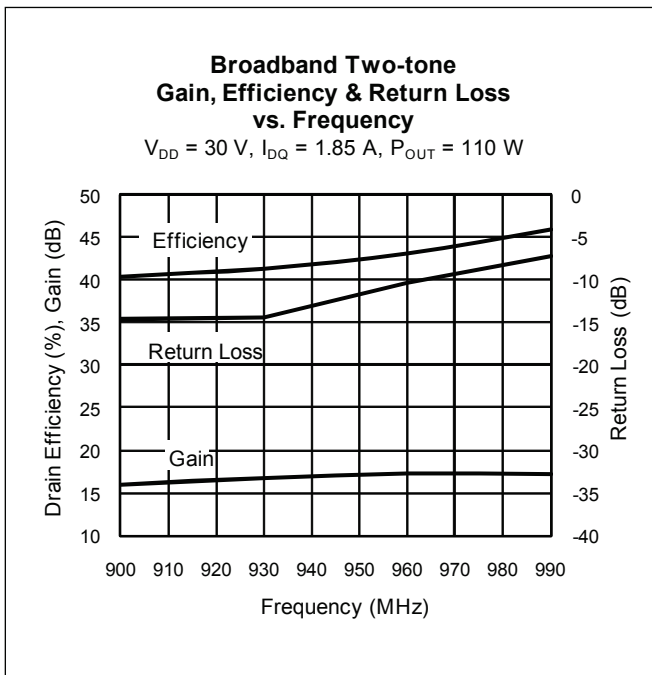
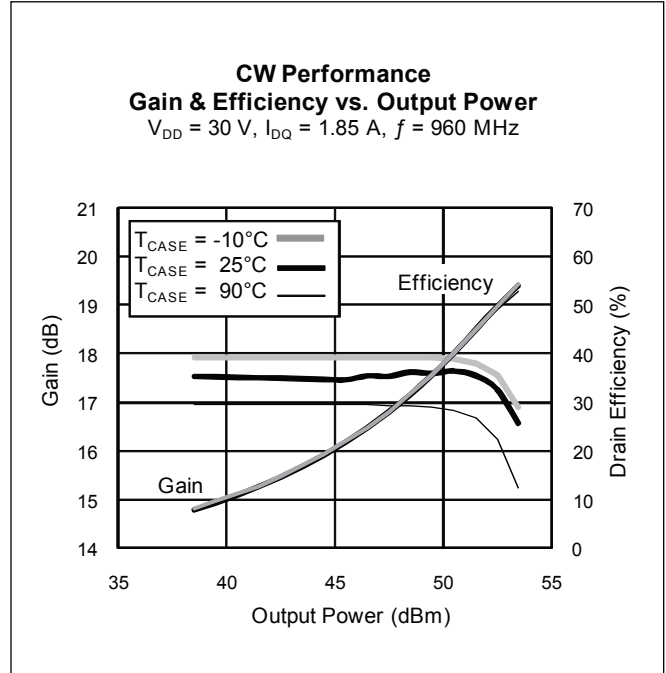
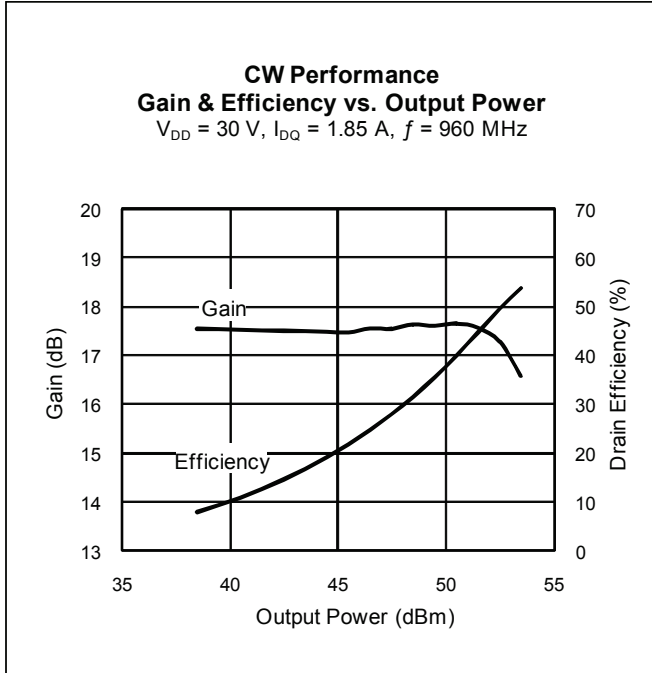

Typical Performance (cont.)

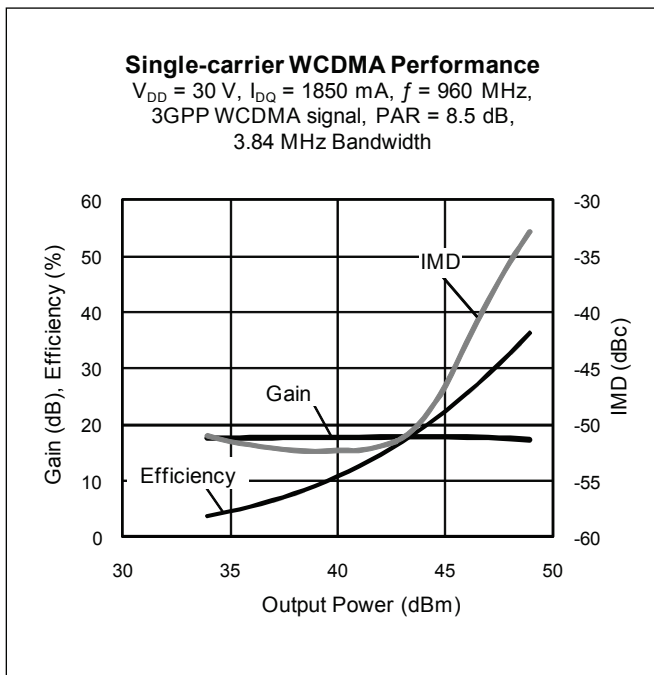
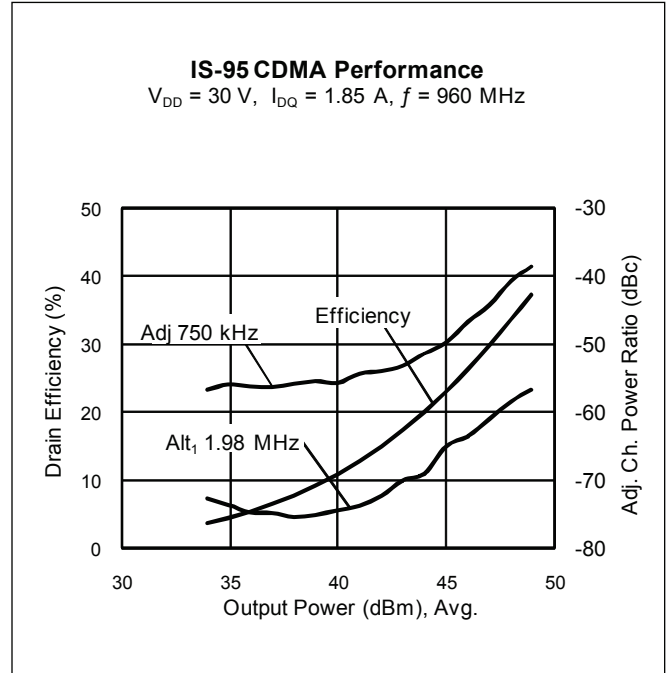
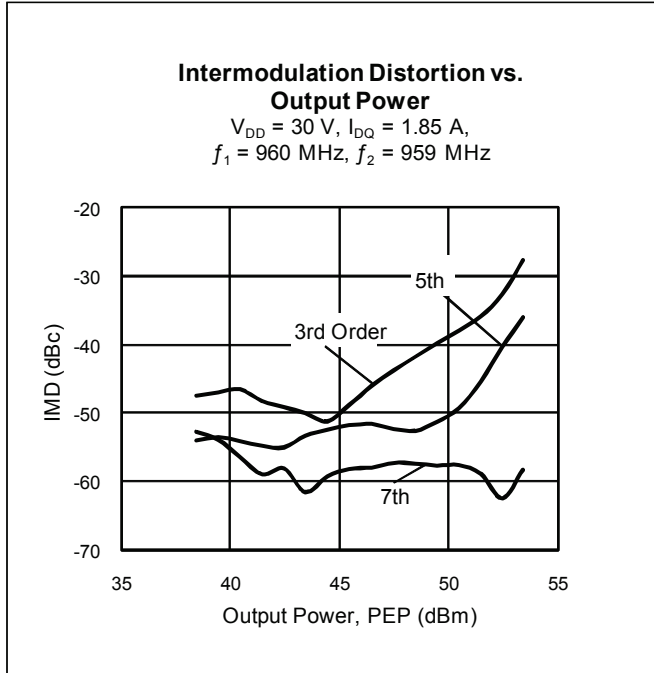

Broadband Circuit Impedance

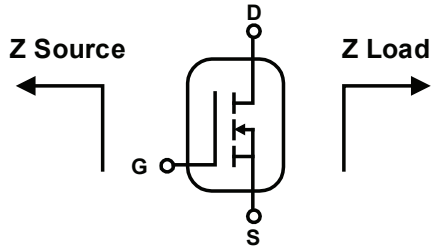

Frequency MHz	Z Source Ω		Z Load Ω	
	R	jX	R	jX
910	1.44	-3.01	1.57	-2.30
920	1.43	-2.92	1.56	-2.18
930	1.42	-2.83	1.55	-2.05
940	1.42	-2.74	1.54	-1.93
950	1.41	-2.66	1.53	-1.81
960	1.41	-2.57	1.52	-1.69
970	1.41	-2.48	1.51	-1.56

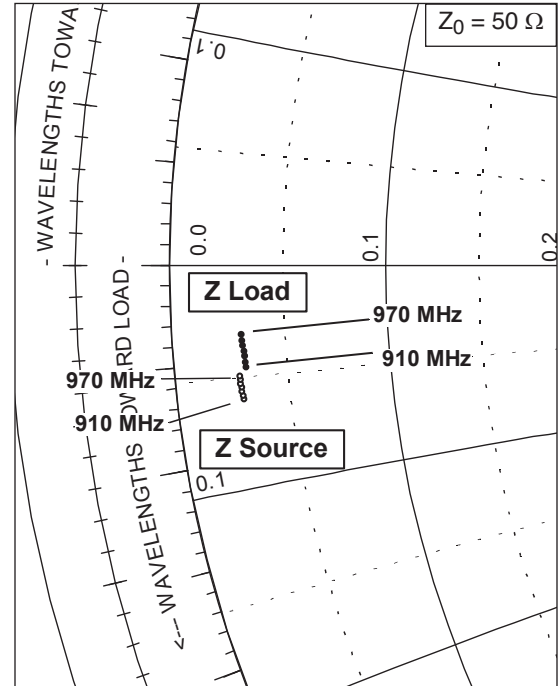

See next page for reference circuit information

Reference Circuit

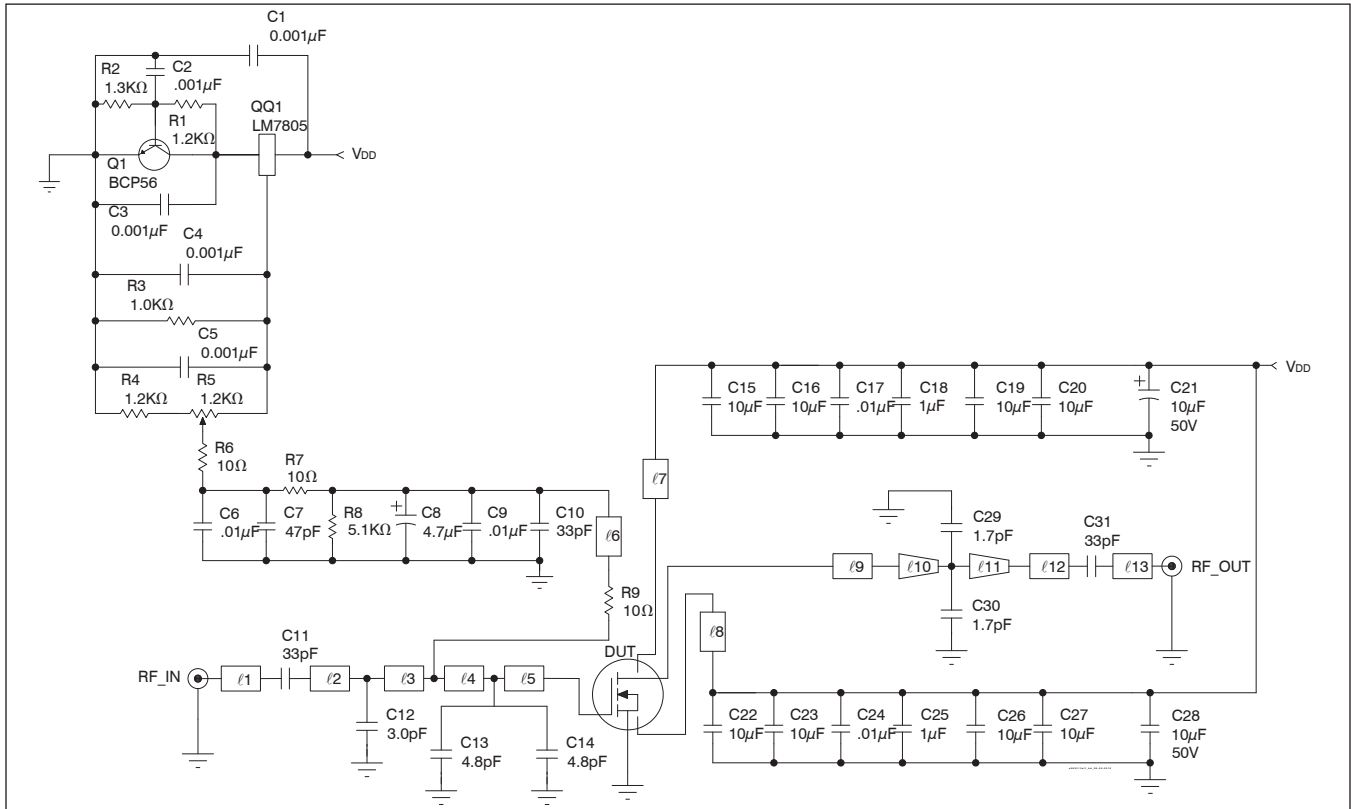

Reference circuit block diagram for $f = 960 \text{ MHz}$

Circuit Assembly Information

DUT	PTFA092213EL or PTFA092213FL	
PCB	LTN/PTFA092213EF	0.76 mm [.030"] thick, $\epsilon_r = 3.48$, Rogers RO4350, 1 oz. copper

Electrical Characteristics at 960 MHz

Transmission Line	Electrical Characteristics	Dimensions: L x W (mm)	Dimensions: L x W (in.)
l1	0.167λ , 50.1Ω	31.75 x 1.65	1.250 x 0.065
l2	0.047λ , 38.0Ω	8.38 x 2.54	0.330 x 0.100
l3	0.039λ , 38.0Ω	7.37 x 2.54	0.290 x 0.100
l4	0.072λ , 7.8Ω	12.45 x 17.78	0.490 x 0.700
l5	0.046λ , 7.8Ω	7.87 x 17.78	0.310 x 0.700
l6	0.163λ , 78.3Ω	31.75 x 0.74	1.250 x 0.029
l7, l8	0.043λ , 23.5Ω	7.75 x 4.95	0.305 x 0.195
l9	0.130λ , 8.3Ω	22.61 x 16.51	0.890 x 0.650
l10 (taper)	0.032λ , $8.3 \Omega / 11.7 \Omega$	5.72 x 16.51 / 11.30	0.225 x 0.650 / 0.445
l11 (taper)	0.053λ , $11.7 \Omega / 37.0 \Omega$	9.78 x 11.30 / 2.64	0.385 x 0.445 / 0.104
l12	0.009λ , 37.0Ω	16.51 x 2.64	0.650 x 0.104
l13	0.167λ , 50.1Ω	31.75 x 1.65	1.250 x 0.065

Reference Circuit (cont.)

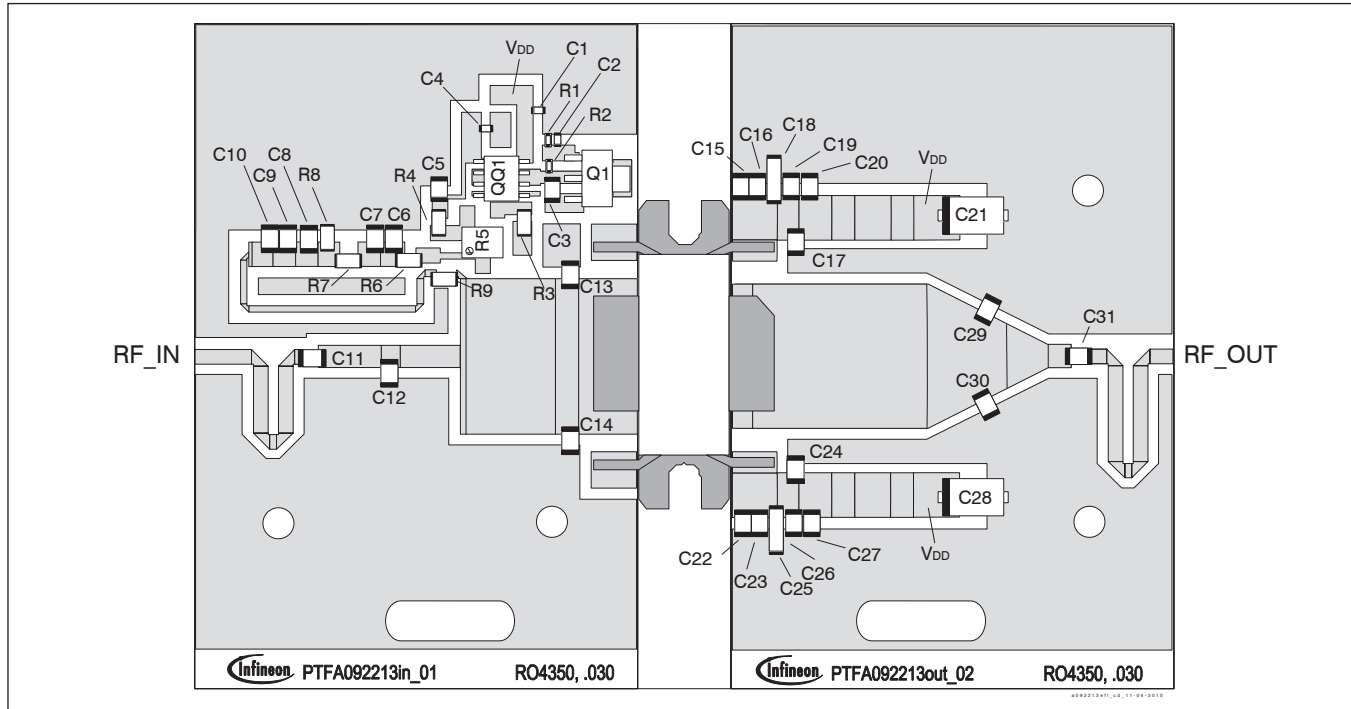

Reference circuit assembly diagram (not to scale)*

Component	Description	Suggested Manufacturer	P/N
C1, C2, C3, C4, C5	Capacitor, 0.001 μ F	Digi-Key	PCC1772CT-ND
C18, C25	Capacitor, 1 μ F	ATC	920C105
C8	Capacitor, 4.7 μ F, 16 V	Digi-Key	PCS3475CT-ND
C6, C9, C17, C24	Capacitor, 0.01 μ F	ATC	200B 103
C15, C16, C19, C20, C22, C23, C26, C27	Tantalum Capacitor, 10 μ F, 50 V	Garrett Electronics	TPSE106K050R0400
C21, C28	Tantalum Capacitor, 10 μ F, 50 V	Digi-Key	P5571-ND
C29, C30	Ceramic Capacitor, 1.7 pF	ATC	100B 1R7
C13, C14	Ceramic Capacitor, 4.8 pF	ATC	100B 4R8
C12	Ceramic Capacitor, 3.0 pF	ATC	100B 3R0
C10, C11, C31	Ceramic Capacitor, 33 pF	ATC	100B 330
C7	Ceramic Capacitor, 47 pF	ATC	100B 470
Q1	Transistor	Infineon Technologies	BCP56
QQ1	Voltage Regulator	National Semiconductor	LM7805
R1, R4	Chip Resistor, 1.2 k Ω	Digi-Key	P1.2KGCT-ND
R2	Chip Resistor, 1.3 k Ω	Digi-Key	P1.3KGCT-ND
R3	Chip Resistor, 2 k Ω	Digi-Key	P2KECT-ND
R5	Potentiometer, 2 k Ω	Digi-Key	3224W-202ETR-ND
R8	Chip Resistor, 5.1 k Ω	Digi-Key	P5.1KECT-ND
R6, R7, R9	Chip Resistor, 10 Ω	Digi-Key	P10ECT-ND

* Gerber Files for this circuit available on request

Package Outline Specifications

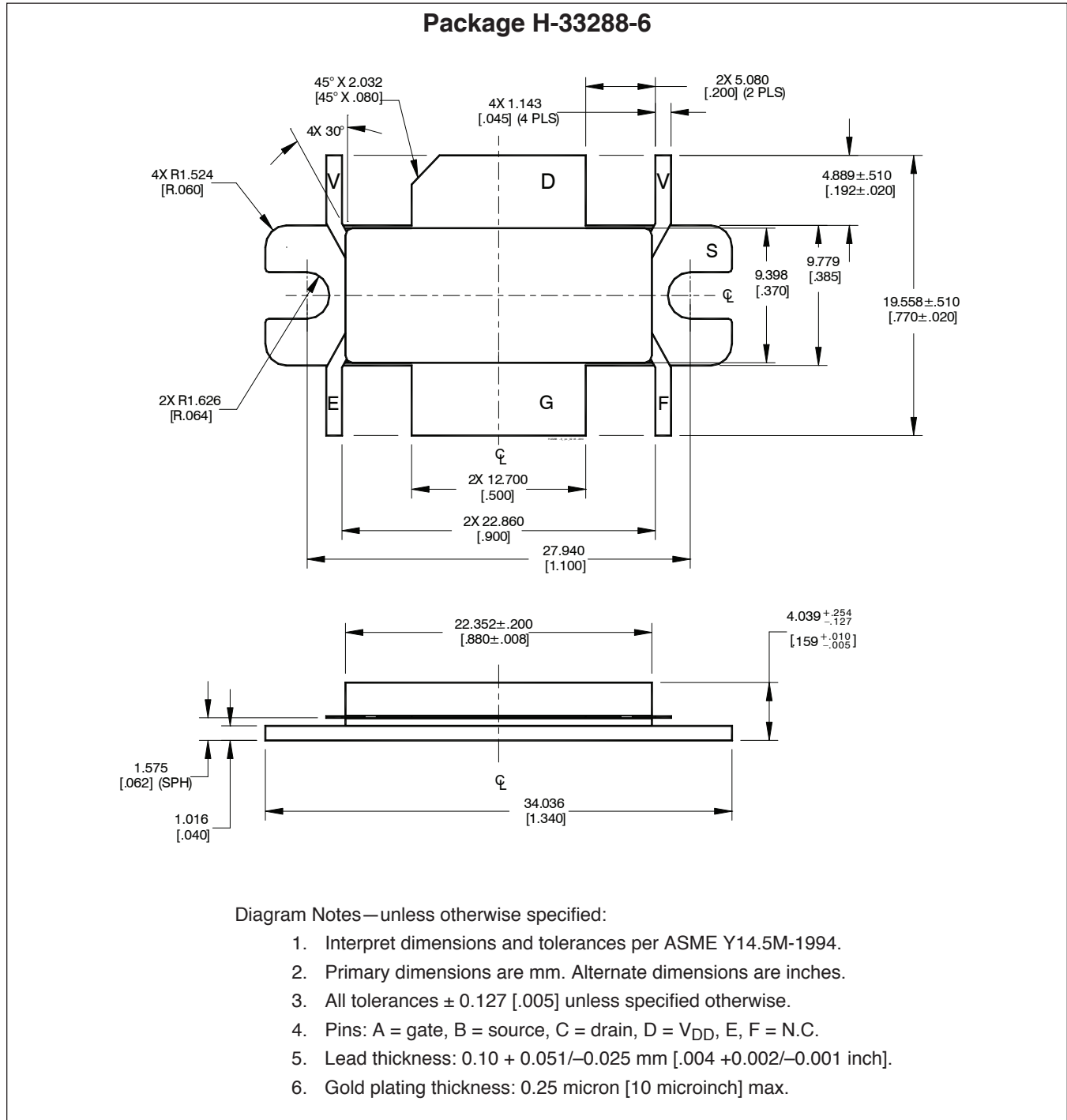

Package Outline Specifications (cont.)

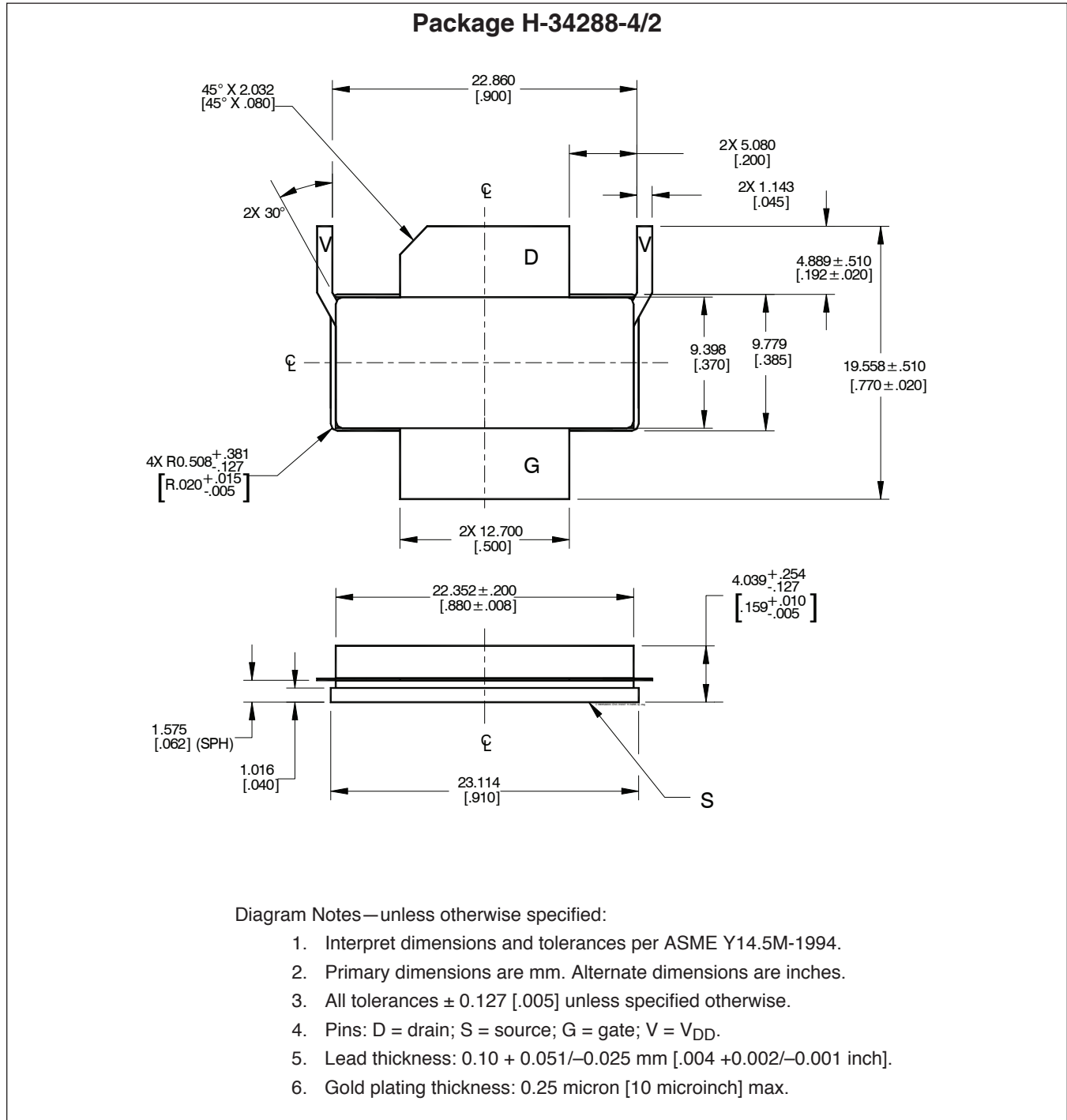

Find the latest and most complete information about products and packaging at the Infineon Internet page
<http://www.infineon.com/rfpower>

Revision History: 2010-11-04 Data Sheet

Previous Version: 2010-09-03, Data Sheet

Page	Subjects (major changes since last revision)
1, 2, 8	Updated eared flange package information

We Listen to Your Comments

Any information within this document that you feel is wrong, unclear or missing at all?

Your feedback will help us to continuously improve the quality of this document.

Please send your proposal (including a reference to this document) to:

highpowerRF@infineon.com

To request other information, contact us at:

+1 877 465 3667 (1-877-GO-LDMOS) USA

or +1 408 776 0600 International

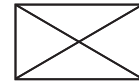

Edition 2010-11-04

Published by

Infineon Technologies AG

81726 Munich, Germany

© 2009 Infineon Technologies AG

All Rights Reserved.

Legal Disclaimer

The information given in this document shall in no event be regarded as a guarantee of conditions or characteristics. With respect to any examples or hints given herein, any typical values stated herein and/or any information regarding the application of the device, Infineon Technologies hereby disclaims any and all warranties and liabilities of any kind, including without limitation, warranties of non-infringement of intellectual property rights of any third party.

Information

For further information on technology, delivery terms and conditions and prices, please contact the nearest Infineon Technologies Office (www.infineon.com/rfpower).

Warnings

Due to technical requirements, components may contain dangerous substances. For information on the types in question, please contact the nearest Infineon Technologies Office.

Infineon Technologies components may be used in life-support devices or systems only with the express written approval of Infineon Technologies, if a failure of such components can reasonably be expected to cause the failure of that life-support device or system or to affect the safety or effectiveness of that device or system. Life support devices or systems are intended to be implanted in the human body or to support and/or maintain and sustain and/or protect human life. If they fail, it is reasonable to assume that the health of the user or other persons may be endangered.